

# OVERSEAS ROAD NOTE 21



***Enhancing the mobility of disabled people:  
Guidelines for practitioners***





TRL Limited  
Old Wokingham Road  
Crowthorne, Berkshire, RG45 6AU



Department for International Development  
1 Palace Street  
London, SW1E 5HE

## **Overseas Road Note 21**

# **Enhancing the mobility of disabled people: Guidelines for practitioners**

The Guidelines were produced by the following project team members:

Dr C J Venter	CSIR Transportek, South Africa
Mrs J Sentinella	TRL Limited
Mr T Rickert	Access Exchange International, USA
Dr D Maunder	TRL Limited
Mr A Venkatesh	Central Institute of Road Transport, India

<i>Subsector:</i>	Transport
<i>Theme:</i>	Improve the mobility of rural and urban poor for meeting their livelihood needs
<i>Project title:</i>	Enhanced accessibility for people with disabilities in urban areas
<i>Project reference:</i>	R8016

This document is an output from a project funded by the UK Department for International Development (DFID) for the benefit of developing countries. The views expressed are not necessarily those of the DFID.

TRL is committed to optimising energy efficiency, reducing waste and promoting recycling and re-use. In support of these environmental goals, this report has been printed on recycled paper, comprising 100% post-consumer waste, manufactured using a TCF (totally chlorine free) process.

## **The Department for International Development: a brief mission statement**

The Department for International Development (DFID) is the UK Government department responsible for promoting sustainable development and reducing poverty. The central focus of the Government's policy, based on the 1997 and 2000 White Papers on International Development, is a commitment to the internationally agreed Millennium Development Goals, to be achieved by 2015. These seek to:

- Eradicate extreme poverty and hunger
- Achieve universal primary education
- Promote gender equality and empower women
- Reduce child mortality
- Improve maternal health
- Combat HIV/AIDS, malaria and other diseases
- Ensure environmental sustainability
- Develop a global partnership for development

DFID's assistance is concentrated in the poorest countries of sub-Saharan Africa and Asia, but also contributes to poverty reduction and sustainable development in middle-income countries, including those in Latin America and Eastern Europe.

DFID works in partnership with governments committed to the Millennium Development Goals, with civil society, the private sector and the research community. It also works with multilateral institutions, including the World Bank, United Nations agencies, and the European Commission.

DFID has headquarters in London and East Kilbride, offices in many developing countries, and staff based in British embassies and high commissions around the world.

DFID, 1 Palace Street, London SW1E 5HE

DFID, Abercrombie House, Eaglesham Road, East Kilbride, Glasgow G75 8EA

Tel: +44 (0) 20 7023 0000

Fax: +44 (0) 20 7023 0019

Public Enquiry Point: 0845 300 4100 (from outside the UK: +44 1355 84 3132)

DFID website: [www.dfid.gov.uk](http://www.dfid.gov.uk)

Email: [enquiry@dfid.gov.uk](mailto:enquiry@dfid.gov.uk)

## ACKNOWLEDGEMENTS

The authors wish to acknowledge the valuable comments received on earlier drafts of the Guidelines from a peer group comprising: Dr Mandke, Dr C Mitchell, Mr J Stanbury, Mr G Menckhoff and Ms A Werneck.

In addition, the authors gratefully acknowledge the inputs over the entire duration of the project from the following personnel who comprised members of research teams in the UK, South Africa, Malawi and Mozambique:

Mrs T Savill, UK

Ms H Bogapane, South Africa

Ms A Meyer, South Africa

Mr M Mashiri, South Africa

Ms N Mulikita, Malawi

Mr C Khaula, Malawi

Dr B Gallagher, Malawi

Dr A Munthali, Malawi

Mr J Camba, Mozambique

Mr K de Deus, Mozambique

Mrs S Stoneman, UK

The authors wish to acknowledge the contribution of Access Exchange International in collating information for Appendix B.

Finally, the contribution of numerous members of staff from the Central Institute of Road Transport, Pune, India is acknowledged, with grateful thanks to the Director, Mr A Lakra.

## OVERSEAS ROAD NOTES

Overseas Road Notes are prepared principally for road and transport organisations in developing countries. A limited number of copies are available to other organisations and to individuals with an interest in road management, and may be obtained from:

Centre for International Development

TRL Limited

Crowthorne

Berkshire, RG45 6AU

United Kingdom

[www.trl.co.uk](http://www.trl.co.uk)

Limited extracts from the text may be reproduced provided the source is acknowledged. For more extensive reproduction, please contact TRL using the postal or website address above.

## FOREWORD

Encouraging greater access to transport, including public transport modes, can substantially transform the livelihoods of disabled people and their immediate families. People with disabilities are specifically recognised as a vulnerable population, due to the double penalty of societal discrimination and physical exclusion which often traps them in poverty. Inaccessible transport can make it especially difficult for disabled people to find employment, to gain an education and access health care, as well as limit their social and recreational activities. In addition, poverty is characterised by the inability to be able to afford to live in areas with easy access to social services. Ideally, disabled people should be able to travel locally or within urban and suburban areas using public transport and other modes with ease. Sadly, however, in cities within developing and transition countries this is the exception rather than the rule.

Improved mobility is a crucial and necessary element in alleviating poverty throughout the developing world as it can allow people with disabilities to play an active role in society both economically and socially. Countries in the developed world have made significant progress in improving the accessibility of transport systems to people with disabilities, and adhere to standards that are generally uniform (albeit with local variations). Among developing and transition countries the situation is much more diverse. Accommodation of the needs of people with disabilities is still largely seen as a welfare function of the state and of non-governmental welfare organisations. The human rights approach to disability, where every citizen has the right to be included in social and economic opportunities, is however, slowly gaining acceptance. In some developing and transition countries awareness is growing of the need to gradually remove barriers in the transport environment. The trend is strengthened when stakeholders realise that the same features that benefit people with physical, sensory and cognitive impairments also benefit other travellers. Slow progress is partly caused by funding constraints, but also by a lack of good practice and awareness: thus where features are included they are not always appropriate to the needs of travellers.

Overseas Road Note 21 entitled *Enhancing the mobility of disabled people: Guidelines for practitioners* is aimed at improving access to transport and hence reducing mobility barriers of disabled people in developing and transition countries. Although basic problems faced by

disabled travellers are similar worldwide, access solutions cannot simply be transplanted from developed to developing countries as clearly, priorities, resources, and operating conditions vary greatly. The Road Note utilises principles of universal design to improve access to pedestrian and public transport systems for all users.

Peter O'Neill

Head of Knowledge and Research

Central Research Department

Department for International Development (DFID)

# CONTENTS

	Page
Foreword	<i>iv</i>
Contents	<i>vii</i>
Glossary	<i>xiii</i>
<b>Part 1: Introduction</b>	<b>1</b>
<b>1 About this guide</b>	<b>3</b>
<b>2 Disability on the agenda</b>	<b>5</b>
<b>3 Why pay attention to transport?</b>	<b>6</b>
<b>4 Disability and barriers to transport</b>	<b>8</b>
<b>5 Outline of the guide</b>	<b>11</b>
<b>6 References</b>	<b>12</b>
<b>Part 2: Setting up a programme for improving access</b>	<b>15</b>
<b>1 Introduction</b>	<b>17</b>
Background	17
<b>2 Advocacy</b>	<b>19</b>
<b>3 Formulating policy and legislation</b>	<b>25</b>
Process of developing policy and legislation	26
Principles for developing policy and legislation	29
<b>4 Cooperation and consultation</b>	<b>32</b>
<b>5 Funding</b>	<b>35</b>
Funding for pedestrian infrastructure and public transport	35
Funding for door to door transport	36
<b>6 Strategies for planning and implementing access improvements</b>	<b>39</b>
The need for coordination	39
Two strategies for incremental implementation	40
The use of access audits	41
<b>7 References</b>	<b>44</b>
<b>Part 3: Guidelines on good access practice</b>	<b>47</b>
<b>1 Introduction</b>	<b>49</b>
<b>2 Principles of good practice</b>	<b>50</b>

	<i>Page</i>
Safety	51
Accessibility	53
Reliability	53
Affordability	55
<b>3 Basic information</b>	<b>56</b>
Clear ways for walking	56
Wheelchairs	57
Walking distances	58
Standing	59
Step heights	59
Colour contrast	59
References	60
<b>4 Personal mobility</b>	<b>62</b>
Types of mobility aids	62
Wheelchairs, Tricycles and Trolleys	63
Walking aids	63
Lower limb prostheses and orthoses	64
Long and guide canes	64
Guide dogs	67
Basic principles	68
Good practices	68
The role of Government	68
Locally made devices	69
Local workshops	69
Mass production in developing countries	70
Imported devices	71
Wheelchair design guidelines	71
Mobility assessment	71
Mobility training	72
Funding	72
Where to start?	72
References	73
Further references	74
<b>5 Pedestrian footways</b>	<b>75</b>
Basic principles	75
Good practices	76
Surface quality	76
Width	77
Height	77
Simplicity of layout	77
Tactile guideway	78
Tactile warnings	79

	<i>Page</i>
Gradient	80
Maintenance	81
Footbridges and subways	81
Rest areas	81
Guardrails	81
Where to start?	82
Further references	83
<b>6 Street crossings</b>	<b>85</b>
Basic principles	85
Good practices	86
Crossing design	86
Kerb ramps	87
Traffic signals	89
Tactile warning surfaces	89
Traffic calming	89
Guardrails	89
Where to start?	90
Further references	91
<b>7 Bus stops</b>	<b>92</b>
Basic principles	92
Good practices	93
Location and spacing of bus stops	93
Surface quality	93
Bus stop layout	93
Shelters and benches	95
Bus stop poles and information	95
Boarding area	97
Enforcement of no-parking zones	97
Wheelchair access through raised boarding structures	97
Where to start?	100
Further references	102
<b>8 Facilities for informal modes of transport</b>	<b>103</b>
Basic principles	104
Good practice	104
Layout	104
Pedestrian clearways	105
Surface quality	106
Seats and shelters	106
Passenger amenities	107
Signage and information	107
Where to start?	107
Further references	111

	<i>Page</i>
<b>9 Design and operation of buses</b>	113
Basic principles	114
Good practices	115
Bus entrance	115
Handrails and stanchions	115
Seats and floor	118
Boarding for wheelchair users	120
Wheelchair space	120
Bell pushes	122
Signage and information	123
Driver operation	123
Fare policy	124
Where to start?	124
Further references	125
<b>10 Mini / midibuses</b>	127
Basic principles	128
Good practices	128
Vehicle entrance/exit	128
Seating	129
Access for wheelchair users	129
Signage	130
Communication	130
Operating practices	131
Where to start?	131
Further references	135
<b>11 Design and operation of trains</b>	136
Basic principles	136
Good practices	137
Boarding for wheelchair users	137
Boarding using steps	138
Layout of carriage	138
Accessible carriages	139
Signage	139
Communication	139
Fare policy	140
Where to start?	140
Further references	141
<b>12 Bus and train stations</b>	142
Basic principles	143
Good practices	143
Entrances	143
Layout of station	145

	<i>Page</i>
Ramps	144
Steps and stairs	147
Escalators, lifts and stair lifts	148
Pedestrian clearways	149
Handrails	149
Signage	150
Tactile and visual guidance	150
Platforms at rail stations	150
Information	151
Amenities	152
Where to start?	155
Further references	155
<b>13 Car parking</b>	<b>156</b>
Basic principles	156
Good practices	156
Number and location of parking spaces	156
Layout	157
Enforcement	158
Where to start?	158
Further references	158
<b>14 Signage and travel information</b>	<b>159</b>
Basic principles	160
Good practices	160
Size and format of signage	160
Placement of signs	161
Colour contrast	162
Tactile signage	163
Printed material	163
Audible information	164
Emergency information	164
Where to start?	164
Further references	164
<b>15 Specialised transport services</b>	<b>166</b>
Basic principles	167
Good practices	167
Door-to-door services	167
Choice of vehicle	167
Choice of operator	168
Trip reservation	169
Eligibility	169
Vehicle scheduling	169
Service routes	169

	<i>Page</i>
Choice of vehicle	169
Route planning and schedule	169
General	170
Fares	170
Operating rules	170
Training	170
Where to start?	171
Further references	172
<b>16 Training</b>	<b>173</b>
Basic principles	174
Good practices	174
Training courses	174
Training of users	175
Where to start	176
Further references	177
<b>Appendix A: Norms and guidelines for selected                   infrastructure and vehicle access                   features</b>	<b>178</b>
<b>Appendix B: Further resources</b>	<b>181</b>

## GLOSSARY

Access audit	A technical evaluation to systematically assess the level of barrier-free access provided by a facility, and to identify what needs to be done to make the facility completely barrier-free.
Accessibility	Able to be reached, entered, influenced, or understood <sup>1</sup> .
Auto rickshaw	Type of informally provided public transport, especially prevalent in South Asia, in which a small three-wheeled vehicle, running on a motorcycle or scooter engine, is utilised to provide a door-to-door taxi service.
Bollard	Short post or pole used to prevent motorised vehicles from entering an area used by pedestrians.
Blister paving	Concrete surface or tiles with raised domes about 25mm in diameter, used to provide a tactile warning to vision impaired pedestrians at street crossings; also called 'bubble blocks'.
Bus bulb	Extension of a paved footway across a parking lane to the edge of a traffic lane, to enable a bus to pull up close to the footway at the bus stop; also known as a full or half width boarder.
Calliper	Walking aid consisting of a support for the leg made of two metal rods extending between a foot plate, and a padded thigh band and worn so that the weight is born mainly on the hipbone <sup>2</sup> .
Cane	Aid used by visually impaired people to enable them to travel independently. (For more technical details see Part III, Section 4).
Clearway	Minimum width pedestrian walkway cleared of street furniture and other obstructions, thus providing a clear throughway for disabled and other pedestrians.
Code of practice	Recommended practice for design and operation of facilities and services; not necessarily enforceable, but intended to provide guidance on best practice.
Concession agreement	Contract (generally 3 to 5 years) spelling out the rights and responsibilities of transport providers ( <i>concessionaires</i> ) and the rights and responsibilities of the government agency granting the concession.
Crossfall	Slope at an angle (usually 90 <sup>o</sup> ) to the normal direction of walking; used for drainage purposes.
Cross-subsidisation	Process by which part of the income from more profitable operations is used to offset the losses of less profitable public transport operations.

---

<sup>1</sup> *The Concise Oxford Dictionary of Current English, 6th Edition, 1976.*

<sup>2</sup> *Webster's Third New International Dirctionary, 1961.*

Crutch	Type of walking aid that shifts the force of upright movement from the legs to the upper body (For more technical details see Part III, Section 4).
dB	Decibel, the unit in which the volume of sound is measured.
Disability	A condition imposed on people with impairments (cognitive, physical, sensory) by society (see Social Model of Disability – Part 2).
Footway	A travel way used by pedestrians only; in this report footway refers both to a pedestrian way that is adjacent to a street or road (in some countries known as a sidewalk or pavement) and to a pedestrian way that is not next to a road (also called a footpath).
Grabrail	A horizontal or vertical pole or rail, sturdily fixed to a structure of a building or vehicle, and used by people to steady or support themselves while moving.
Gradient	Slope or angle, usually expressed as ratio of vertical rise to the horizontal distance over which the rise takes place.
Guardrail	Sturdy railing to prevent pedestrians from walking into a dangerous area such as a construction zone.
Reliability	Relating to consistency across all the elements of a journey.
Guide cane	Aid used by visually impaired people for protection or for checking for kerbs and steps by using a scanning technique; the normal length of a guide cane would be from just above the user's waist to the ground when in an upright position.
Handhold	Short handrail affixed to for instance the top of bus seats; also known as a 'hand grasp' or 'grab handle'.
Hawker	Vendor selling wares, usually in informal stalls on streets or public spaces.
Impairment	Any loss or abnormality of psychological, physiological or anatomical structure or function.
Induction loop	A system that helps hearing impaired people who use a hearing aid or loop listener to hear sounds more clearly by reducing or cutting out background noise.
Informal transport	Public transport provided by large numbers of individual operators, usually with small vehicles such as mini or midibuses and following loosely organised routes and schedules.
Kerb ramp	Section of pavement edge where kerbstone is sloped to provide barrier-free access between kerb and street; also known as dropped kerbs, bevelled kerbs or kerb cuts.
Lay-bye	On-street stopping place, in the form of a bay for public transport vehicles (usually informal operators such as minibus-taxis) to pull out of a traffic lane for passenger boarding and alighting.

Long cane	Aid used by visually impaired people to scan the local environment; the normal length of a long cane would be from above the user's sternum to the ground when in an upright position.
Micros	Type of informally provided public transport vehicle (usually a minibus).
Minibus-taxi	Type of informally provided public transport in which mini / midibuses are utilised to provide transport along fairly fixed routes; schedules are generally quite flexible.
Mobility aid	A wide range of assistive devices suitable for people with various type of disabilities (For more technical details see Part III, Section 4).
Motorcycle-taxi	Type of informally provided public transport, especially prevalent in many towns and cities in Africa and South Asia, in which two-wheeled vehicles are used to provide a door-to-door taxi service.
NGO	Non-government organisation.
Orthosis	Limb support such as callipers.
PA	Public announcement.
Parking lane	Lane in a street used for parking vehicles.
Pinch point	Type of traffic calming measure where deliberate narrowing of the traffic lanes decreases the travel speed of vehicles; also called a choker.
Prosthesis	Artificial limb.
Raised cross-walk	A speed hump that is wider than a normal speed hump, marked as a pedestrian crossing, and at the same level as the adjoining pedestrian footways.
Rank	Public transport facility at the end of a route where passengers board or alight (usually for informal operators).
Service routes	Accessible public transport service, usually utilising medium or full-sized vehicles, and operating along fixed routes which are specifically chosen to connect origins and destinations frequently used by older and disabled passengers.
Stairlift	Mechanical lift device attached to the side of a stairway, used to transport people using wheelchairs up or down the stairs.
Stanchion	Vertical grabrail, usually on buses / trains.
Step nose	Edge of step.
Step riser	Vertical part of step.
Tactile	Perceptible to touch.
TDD	Telecommunications Display Device; also known as a text telephone.

Travel chain	Traveller's complete journey pattern, including all walking, waiting and in-vehicle portions.
Trolley	Assistive device developed for people who need to complete tasks at floor level.
Universal design	Design of facilities to ensure they can be used by everyone; also referred to as inclusive design.
Walking aid	Assistive device used to provide support, greater stability and balance for the user (For more technical details see Part III, Section 4).
Walking frame	Sturdy metal frame with four legs used to provide support for persons with walking difficulties; also called 'walkers'. (For more technical details see Part III, Section 4).
Walking stick	Walking aid, usually made out of wood or metal, and used to provide support for people who have difficulty walking (For more technical details see Part III, Section 4).

# Part 1: Introduction



# 1 About this guide

---

***This section introduces the guidelines. It describes the objectives and intended use of the guidelines, and provides some background on disability and transport in the developing world. It highlights why it is important to improve access to enhance the mobility of disabled people in all parts of the world.***

This guide summarises some examples of good practice worldwide with regard to improving the ability of people with disabilities to have greater access and mobility in their daily lives. It is aimed at engineers, planners, central and local government officials, policy makers, transport operators, and people with disabilities in developing countries, to enable them to work together towards improving the mobility of people with disabilities.

Improving disabled people's mobility goes wider than just making physical improvements to the transport system:

- it also requires access to wheelchairs and walking aids;
- transport services to be offered at affordable prices;
- provision of adequate information to users; and
- policies and management practices to be in place to promote the inclusion of people with disabilities in all aspects of society.

These guidelines take a comprehensive approach to land based transport in urban areas, giving information on a range of technical, policy and practical issues relating to people with disabilities.

The guidelines recognise that different countries have made different degrees of progress towards addressing the mobility needs of travellers with disabilities. Approaches towards disability vary, as do the amount of resources that can be allocated. Yet across the world awareness of the needs of disabled people is growing, and their access and mobility needs are increasingly receiving attention from governments and non-governmental organisations. Consensus is emerging on the ultimate goal – to provide barrier-free and equal access to all people with disabilities. These guidelines assume that many useful lessons can be exchanged between different countries. Local cultural and physical factors will certainly shape the form and the detail of mobility solutions in each locale, but the basic needs of people with various disabilities are similar enough that what is considered good practice in one part of the world can be relevant to another.

The guidelines draw on a variety of sources to identify good accessibility practice<sup>1</sup>. Countries in Europe and North America have had three decades of experimentation with standards and practices to remove mobility barriers to people with disabilities. Many of the practices recommended in this document reflect standards of good practice that are available in these countries.

Some countries in the developing world have made significant progress in developing their own standards and guidelines dealing with conditions and problems relevant to their own circumstances – particularly in Latin America – and this experience is also reflected here as much as possible. Lastly, it was recognised that solutions are sometimes developed or applied informally in a wide spectrum of countries. An attempt was made to incorporate such relevant examples from Africa and Asia using case study material.

The focus of the guidelines is mobility and access in *urban and peri-urban* areas, rather than rural areas. While many of the practices discussed here can be applied outside cities, rural areas also have other challenges that could not be addressed within these pages. Urban areas are in general better resourced (both in financial and institutional capacity terms) and provide perhaps better opportunities for starting to address the transport problems of disabled people.

To be as practical as possible, the guidelines make suggestions on how particular problems can be tackled incrementally, taking resource constraints into consideration. What may be reasonably achievable in one country may be inappropriate in another, and the guidelines recognise this by relating suggested actions to the level of resources locally available.

---

<sup>1</sup> *Since this study was started the UK's Department for Transport (Oxley, 2002) has published accessibility guidelines on access to pedestrian and transport infrastructure, 'Inclusive Mobility'. This publication has been frequently referenced in these guidelines and heavily drawn upon, though to reflect the local environment countries may need to modify the UK's best practice specifications.*

## 2 Disability on the agenda

---

Across the world disability awareness is rising on the political agenda. Many countries have passed laws prohibiting discrimination against disabled people in the areas of government service delivery, physical access and transport. The goal of promoting greater access has been adopted worldwide through the United Nations' Standard Rules on the Equalisation of Opportunities for Persons with Disabilities, adopted by the General Assembly in 1993 (see Box 1.1).

### **Box 1.1 UN Standard rules on the equalisation of opportunities for persons with disabilities**

'... States should initiate measures to remove the obstacles to participation in the physical environment. Such measures should be to develop standards and guidelines and to consider enacting legislation to **ensure accessibility to various areas in society**, such as housing, buildings, public transport services and other means of transportation, streets and other outdoor environments...'

The Standard Rules are based on the so-called Social Model of Disability, which has become the model advocated by many people with disabilities worldwide. The Social Model sees the collective disadvantage of disabled people as being due to their societies' inability to accommodate their varied needs, rather than as a problem of the individual. The Social Model makes it clear there is a distinction between impairment and disability:

- *Impairment is '... any loss or abnormality of psychological, physiological or anatomical structure or function ...' (WHO, 1980).*
- *Disability is a process of exclusion of people with impairments, which is seen as neither inevitable nor acceptable (Porter, 2002).*

What is needed, therefore, is for society to be restructured in order to accommodate greater diversity in its institutions, social relations and physical environment.

### 3 Why pay attention to transport?

---

People with physical, sensory and cognitive impairments are increasingly demanding that the barriers that *disable* them in the transport environment be removed so that they can carry out social, recreational and business activities and live more satisfying lives. Environments that cause no problem for young adults sometimes become barriers for older people. Problems with transport are consistently identified by disabled and older people as major reasons why they remain isolated from society.

In developing countries their inability to access education, healthcare or job opportunities contributes significantly to trapping them and their families in poverty. With the UN commitment to halving the proportion of people living in extreme poverty by 2015, poverty eradication is a pressing policy aim.

Many underdeveloped countries now have Poverty Reduction Strategy Programmes in place, which function as the central axis of government policy intervention. Recent World Bank estimates show that people with disabilities account for as many as one in five of the world's poorest (DFID, 2000). *If international targets on poverty reduction are to be reached, it is critical that specific measures be taken to reduce discrimination and isolation of disabled people. Improving their mobility and physical access to livelihood opportunities needs to be a core part of such a strategy.*

Following the Social Model of Disability, many disabled people are demanding that their needs be addressed through the regular transport system. There is ample evidence that, in general, integration of the majority of disabled people on mainstream public transport services is in the long term the cheapest and most effective option. Dedicated parallel systems, while more costly, may be desirable for serving those who cannot use accessible public transport, or as a transitional strategy while the transport system is being upgraded.

Improved mobility for people with disabilities can benefit society by enabling them to find employment or to live independently, thus reducing the need for costly institutional care or to take services to people in their homes. Shaping transport to meet the needs of people with disabilities not only assists them, but also leads to systems and infrastructure that are easier and safer for everybody to use.

Studies have shown that at any one time, between 20 and 30 percent of people travelling have a mobility impairment for one reason or another – including people with temporary health conditions, frail

elderly people, pregnant women, parents with young children and people carrying shopping bags or goods (ECMT, 1999). By providing transport that better accommodates all of these people, the pool of potential passengers to public transport enlarges significantly, thus increasing potential revenues to cash-strapped public transport operators. In fact, the whole population benefits from footways and transport services that are safer and easier to use.

*These guidelines use the principles of universal design and universal mobility: that improving transport for people with disabilities benefits everyone in society.*

## 4 Disability and barriers to transport

Accurate data on disability is scarce, especially in developing countries where more problems exist with varying definitions and under reporting of disability in surveys. The United Nations estimates that between 6% and 10% of people in developing countries are disabled (*Despouy, 1993*), with higher incidences often found in countries with civil strife or poor primary health care systems. The growing number of people with impairments in many societies is increasing the pressure on governments to better cater for their needs for transport and other services.

People with disabilities do not form a homogeneous group, but consist of people with a wide variety of abilities and needs. While the precise classification of different types of disabilities is fraught with difficulties, Table 1.1 gives an indication of the proportion of disabled people with different types of impairments for a selection of countries, as reported in census studies.

**Table 1.1 Examples of proportion of disabled people with different types of impairment**

	% with type of impairment*				
	<i>Vision</i>	<i>Hearing/ Speech</i>	<i>Physical</i>	<i>Cognitive</i>	<i>Other (Incl. Multiple)</i>
India (1991)	23%	26%	51%	–	–
Latin America**	27%	20%	29%	14%	10%
Malawi (1983)	21%	13%	18%	9%	39%
Mexico (2000)***	29%	21%	45%	15%	1%
South Africa (1996)	41%	15%	21%	7%	16%

\* *No attempt was made to correct for variations in the definitions used.*

\*\* *Averaged over 9 countries (Dudzik et al., unpublished).*

\*\*\* *Figures add up to more than 100% because people with multiple disabilities are counted in more than one column (Dudzik et al., unpublished).*

Based on these figures and studies from individual countries in Latin America it is likely that in most developing countries the number of people with sensory disabilities (including blind, low vision, deaf, hard-of-hearing, and speech) is about 40 to 50 percent of all disabled people; people with various physical disabilities (such as cerebral palsy, paraplegia and amputations) are in the 20% to 50% range; and people with mental disabilities (such as learning, psychiatric and cognitive

disabilities) are in the 7 to 15% range. Large numbers of disabled people have multiple disabilities with a combination of specific needs.

People with physical disabilities include both ambulant disabled people and wheelchair users. While most disabled people are able to walk – with or without assistance or the aid of devices such as crutches, braces or walking frames – others must use wheelchairs for mobility.

Seemingly small things in the pedestrian or public transport environment can present huge obstacles that can cause a significant degree of extra effort, stress, and pain. Focus group discussions held in various countries as part of this research showed that hearing impaired people seem to be most mobile, while users of wheelchairs are often least able to move around independently, especially if they are also frail (*Venter et al., unpublished*) (Box 1.2).

Because of the structural barriers prevalent in the transport system, many people need assistance either from an escort or from drivers and other passengers. Yet other people's unwillingness or inability to give help in appropriate ways, whether because of attitude or of ignorance of the needs of disabled people, is often felt to be a social barrier to mobility.

High transport costs are often more of a problem for disabled travellers than for others, especially since people with disabilities are often unemployed and therefore poorer. In addition, they are frequently required to pay extra for transporting their mobility aids (such as folded wheelchairs). The high cost, or simply the unavailability, of mobility aids is also a major barrier to mobility in many least developed countries.

## Box 1.2 Examples of problems experienced by disabled people when travelling

'Many times when I request passers-by to help me cross the road, they do so either by clutching my shirt collar or shirt sleeves. At that moment I feel so inferior and insignificant'. (Vision impaired person, India)



*Figure 1.1 High kerbs at pavements force some users to cross the street at dangerous places*

'If the platform number changes, I cannot hear the announcement. I only see everybody is moving away, and I get confused.' (Hearing impaired person, South Africa)

'Wheelchair users cannot enter the *micros* – even with help to get me on and off it is almost impossible as the doors are too narrow.' (Wheelchair user, Mexico City)



*Figure 1.3 Informal traders blocking the footway makes this area very hard to use*

'The aid which we are supposed to get from the hospitals is not enough to sustain all the people in need. For example, for one to get crutches, callipers or a wheelchair, it can take years, even just to repair these things.' (Physically impaired person, Malawi)



*Figure 1.2 Inaccessible entrances and overcrowding cause some people severe problems in entering buses*

'They (minibus-taxi drivers) do not wait when they see you coming – and that you are disabled – they just drive away.' (Disabled passenger, South Africa)

Source: Focus group discussions, Venter et al., (unpublished)

## 5 Outline of the guide

---

The remainder of these guidelines consists of three sections.

***Part II describes steps that can be taken to initiate a programme for improving accessibility to transport.*** It covers policy formulation, planning, and funding of improvements, and gives advice on how disability advocacy groups and authorities can work together towards achieving common goals. The section is provided so as to be a resource to countries where access policies and strategies are not yet in place, or where guidance is needed on how to move forward on introducing improvements within available resource constraints.

***Part III provides more detailed information on good practice with regard to promoting better mobility for people with disabilities.*** It provides technical guidelines on improvements that can be made to the pedestrian environment, transport infrastructure, vehicles such as buses and minibuses, and the training of drivers. Each section highlights the most important principles to pursue, describes good practice, and provides references that can be consulted (mostly available on the internet) for further information. In addition, each section contains suggestions on where to start implementation and how to prioritise actions.

**Appendices A and B contain further resources, including a comparison of standards and specifications in use in various countries, selected literature and contact information, and other useful materials.**

## 6 References

---

**Department for International Development (DFID) (2000).** *Disability, poverty and development*. London: DFID.

**Despouy L (1993).** *Human rights and disabled persons*. Study Series 6. Geneva: United Nations Centre for Human Rights.

**Dudzik P, Elwan A and Metts R L (2001).** *Disability in Latin America: a review of statistics and inclusionary policies*. An unpublished draft paper prepared for a March 16, 2001, seminar of the Inter-American Development Bank in Santiago, Chile, pp. 24-25.

**European Conference of Ministers of Transport (1999).** *Improving transport for people with mobility handicaps: a guide to good practice*. Paris: OECD.

**Republic of South Africa (1997).** *White paper on an integrated national disability strategy*. Pretoria, South Africa: Office of the Deputy President.

**National Sample Survey Organisation (NSSO) (1996).** *A report on disabled persons*. 47th Round July – December 1991 and *Report on manpower development rehabilitation council of India*. Report No. 393. New Delhi.

**National Statistics Office (NSO) (1983).** *Survey of handicapped persons Malawi 1983*. Zomba, Malawi: Government Printer.

**Oxley P (2002).** *Inclusive mobility – a guide to best practice on access to pedestrian and transport infrastructure*. London: Department for Transport.

**Porter A (2002).** *Compromise and constraint: examining the nature of transport disability in the context of local travel*. *World Transport Policy and Practice*, vol. 8, no. 2.

**United Nations (1993).** *Standard rules on the equalisation of opportunities for persons with disabilities*. General Assembly resolution 48/96 of December 20, 1993. New York: United Nations.

**Venter C J, Savill T, Rickert T, Bogopane H, Venkatesh A, Camba J, Mulikita N, Stone J and Maunder D (2002).** *Enhanced accessibility for people with disabilities living in urban areas.* Project Report PR/INT/248/02, Crowthorne: TRL Limited. *(Unpublished report available on direct personal application or retrievable (2003) from [www.transport-links.org](http://www.transport-links.org)).*

**World Health Organization (WHO) (1980).** *International classification of impairments, disabilities and handicaps: a manual of classification relating to the consequences of disease.* Geneva: World Health Organization.



## **Part 2: Setting up a programme for improving access**



# 1 Introduction

---

*This part of the guideline describes the process of advocating, planning and implementing access improvements within local, political and social contexts. It draws on many strategies that have been found useful in developing countries in promoting better access and mobility.*

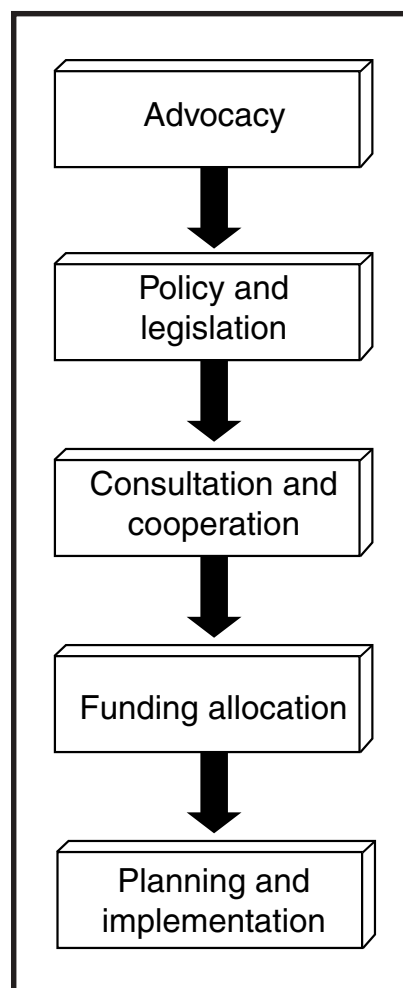

**Figure 2.1** Elements of an access programme

## **Background**

There is significant variation across developing countries with regard to the amount of access that people with disabilities enjoy to livelihood and social opportunities. The variation in political processes and social patterns across countries means that the path to greater access and universal mobility differs considerably. Nevertheless, almost everywhere where significant progress has been made – both in developed and in developing countries – a number of common elements have been found to be helpful and important. These elements (shown in Figure 2.1) are:

- **Advocacy by people with disabilities:** People with disabilities often take the lead in increasing awareness of their needs in society, and demanding greater responsiveness from governments and private sector service providers. Pro-active advocacy by disabled peoples' organisations is seen by many as a very important part of the process of achieving universal mobility.
- **Formulation of policy and legislative frameworks:** In societies that pursue universal mobility, standards and practices are usually formalised by a set of policy and legal instruments. Policy clearly spells out what is to be achieved, and laws create enforceable mechanisms through which to achieve it.
- **Consultation and cooperation between authorities and people with disabilities:** The best results are obtained when governments, transport providers and transport users work together to set common goals and to work out how to achieve them within the constraints of available time and money.
- **Funding:** Sources of funding need to be identified to implement improved access and mobility for disabled people. Due to funding resource constraints in the developing world a number of minimum cost solutions are described in Part III of the guidelines.
- **Planning and implementation of access strategies:** Advocacy, consultation and legal frameworks need to result in implementation. Strategies for planning the deployment of access improvements in the transport environment need to tread a balance between maximising effectiveness and working within resource constraints.

The purpose of this section is to describe each of these processes, showing how they can promote the achievement of universal mobility in different contexts.

The material draws on research, practices and guidelines from a variety of organisations that have been active in this field, especially in developing countries<sup>2</sup>. Not everything will be applicable everywhere, and the guidance offered here has to be tailored to individual circumstances. Nevertheless the general principles may be useful in setting up a programme for improving access.

---

<sup>2</sup> A complete list of sources and further references is provided at the end of this section

## 2 Advocacy

---

In many developing societies negative attitudes towards disability are pervasive, arising from superstition, fear, and misconceptions about disability. Many studies have illustrated how family members with disabilities are kept at home, partly to protect them from an unfriendly society, and partly to avoid the social stigma of having disability in the home (*DFID, 2000*). The first obstacle to greater mobility and social interaction is thus often the negative attitude of society.



**Figure 2.2** The REDI network is a cross-disability network of NGOs advocating transport access in Buenos Aires, Argentina (*Source: Access Exchange International*)

For this reason many organisations of people with disabilities have taken the lead in promoting greater awareness in their local communities of their specific needs. Advocacy by people with disabilities, usually together with other concerned citizens or groups, is considered a crucial element of promoting more appropriate design and operation of transport infrastructure and transport services. People with disabilities know their own needs the best, and are usually best able to tell policy makers, designers and operators how their services can be improved to better meet these needs.

Useful pointers for undertaking effective advocacy include<sup>3</sup>:

---

<sup>3</sup> Many strategies in this and subsequent sections are described in more detail by guidelines issued by UNESCAP (1995), SUSTRAN (2000) and AEI (2003). See references at the end of Part 2. Full details on obtaining these publications can be found in Appendix B.

- ***Effective advocacy is often targeted at a variety of audiences.*** The first audience is often other people with disabilities, to encourage them to demand equal treatment and inclusion in their societies, rather than depending on welfare handouts. This approach is based on the social model of disability, described in Part I of this guideline. Other important audiences include political decision makers, influential community members, professional people (architects, engineers), key government officials, vehicle manufacturers, transport operators, the mass media, and the public at large.
- ***Effective advocacy reaches out to unite persons with different disabilities.*** By working across disability lines – for instance organisations representing people with vision impairments working with people with physical impairments and parents of disabled children – NGOs can become more effective in their advocacy. Cross-disability advocacy also assists transport officials to understand the variety of needs of their disabled passengers, without sending them conflicting or confusing messages about what should be done to their service.
- ***Effective advocacy brings together people with disabilities and other stakeholders.*** These stakeholders may include elderly people, carers with children and others who may not consider themselves disabled. Nevertheless many of these people cannot use transport without many of the features which make it accessible to passengers with disabilities. Transport designed for all benefits more than just disabled persons. Other partners which could be sought out include human rights organisations, faith-based organisations, and agencies serving tourists. Petitions or public statements are much more likely to be taken seriously by authorities when endorsed by a wide range of stakeholders.
- ***Develop a clear strategy with measurable short-term and longer-term goals.*** A short-term goal could be to include access features in a planned new rail station. A long-term goal could be to help the city to adopt a comprehensive policy on making transport accessible to everybody.
- ***A good time for advocating vigorously for access improvements is when new transport facilities or systems are being planned.*** Infrastructure such as new rail stations, busways, or pedestrian facilities can often be made accessible to a wide range of users at negligible additional cost, if they are correctly designed from the beginning. Such highly visible improvements provide good publicity for all stakeholders and encourage officials to do more. Disability advocates need to become involved early on to ensure officials and

designers are aware of their inputs. For example, an Indian NGO called Samarthyaa successfully worked with the Delhi Metro Rail Corporation to ensure that the new Delhi Metro included accessible features right from its inaugural run in 2002 (see Box 2.1).

### Box 2.1 Indian NGO assists with design of new accessible Delhi Metro



**Figure 2.3** Advocates Anjlee Agarwal and Sanjeev Sachdeva board the accessible Delhi Metro on its inaugural run.

(Photograph courtesy of Sanjay Sakaria, from *Amar Ujjala Indian Daily*)

In December 2002 the new Delhi Metro made its inaugural run with fully accessible station infrastructure and coaches. Samarthyaa, a local NGO founded in 1996, worked closely with the Delhi Metro Rail Corporation (DMRC) to ensure that stations are designed to be barrier-free, that rail platforms provide safety features and tactile guideways, and that coaches have adequate space for wheelchair users. Their work subsequently sparked interest from the Central Government's Ministry of Railways, which has requested Samarthyaa's help in designing accessible coaches in other railway services.

- In order for self-help organisations to play their critical role in formulating access legislation, **people should acquire basic technical knowledge of access issues and skills** for dialogue and cooperation with the concerned sectors of society and government. Organisations may consider designating an access team drawn from its members to specialise in mobility and transport issues. Inclusion of prominent and skilled persons with disabilities can play an important role in mobilising grassroots support.
- **Face-to-face contact helps promote understanding.** Get to know key people, such as elected officials, planners, and transport managers. Get to understand their viewpoints. Try to find a champion for your cause in government, the media or a university.
- **Make clear and concise materials available to the public and to people with disabilities.** This can highlight the mobility problems people experience, and provide information on regulations and

requirements for accessibility that are in place. For example, the National Council for Rehabilitation and Special Education and the Office of the President, with assistance from Spain's Agency for International Cooperation, distributed five thousand copies of Costa Rica's National Law 7600, mandating access to transport and other sectors. Alternatively the material can highlight norms and guidelines describing emerging International Standards for access to streets, buildings, and vehicles. Such norms have sometimes been incorporated into enforceable legislation mandating accessible transport. Material can be made available in printed and other formats

- ***Make guidelines for the use of correct terminology available*** to government departments, the mass media, and people who promote access issues (see Section 4). The use of language that avoids evoking pity or guilt can contribute to changing attitudes.
- ***Involve the mass media.*** The television, radio and newspapers can be powerful in promoting positive attitudes and access awareness among both decision makers and the general public. Disability advocates could visit media managers in person to underline the need for improved media coverage of access issues. They could form personal contacts with interested reporters. Reporters and editors may need to be educated themselves on disability issues and the correct use of language. The use of positive reinforcement through publishing examples of successful removal of barriers can help to motivate officials to do more.
- In many countries, ***people with disabilities have held public meetings***, to focus public and media attention on their concerns. Officials and politicians are sometimes moved to act by the desire to avoid negative publicity.
- ***Carry out an 'access audit' of transport facilities.*** This is a technical evaluation to systematically assess the level of barrier-free access provided by a facility, and to identify what needs to be done. (See Section 6 for more information on how to go about it.) Disability advocates can undertake such audits themselves and send the results to the media or to the transport agency or city government.
- ***Launch a national access awareness campaign.*** Such a campaign could combine many of the other strategies mentioned here, and could be especially effective if launched under the auspices of a government department. It could be repeated annually, each year reporting on the progress that has been made, and giving public recognition to excellent and/or innovative access programmes.

- **Take photographs of problems**, showing people struggling to cope with a barrier to access. For example, drawings of disabled people unable to climb stairs have been used effectively in 'The Japan Times' newspaper.
- **Promote ongoing training on access issues**. Training of professionals involved in planning and managing the built and transport environments – including engineers, architects, building managers, inspectors and so forth – is of critical importance to the long-term success of access promotion. Disability organisations should work with universities, colleges and professional institutions to promote the inclusion of access training in regular curricula. This may be particularly helpful in countries where formal controls over the transport environment through Standards and legislation are weak. Disabled people can participate in training courses, giving first hand accounts of their experiences. Access training is always more effective if the trainees can discuss issues with those who are directly affected by them. (See Part III, Section 16 for more on training).
- **Cooperation across disability groups in a region can strengthen advocacy**. Regional cooperation can demand more resources from an organisation, but can also promote effective advocacy through sharing lessons amongst partners in similar circumstances (see Box 2.2).



**Figure 2.4** Disability advocates meet with local transport officials to promote a service route in Ciudad Obregón in northern Mexico. (Photograph: Access Exchange International)

## Box 2.2 *Real Patronato* promotes wide regional cooperation in Latin America



Figure 2.5 Various publications providing guidelines on accessibility in the built and transport environments have appeared in Latin America in recent years

The *Real Patronato Sobre Discapacidad* (Spain's Royal Foundation on Disability) in Madrid has promoted access to the built environment and to public transportation across Latin America. This large agency has in the past funded a team of Latin American architects from Uruguay, Brazil, Argentina, and Colombia to lead a series of workshops on accessible tourism in these countries as well as in Mexico, Costa Rica, and Peru. The *Real Patronato* also published a 300-page guide to the preparation of municipal access plans. While focused on the situation in Spain, the guide is relevant to Latin America and contains a chapter on planning for access to public transport. Adding to this regional vision, the *Real Patronato* has funded the Uruguayan Institute of Technical Norms (UNIT) in its publication of an introductory textbook, *Accesibilidad al Medio Físico* (Access to the Built Environment).

### 3 Formulating policy and legislation

Achieving universal mobility is a complex process involving many stakeholders and evolving over time. Most countries have found that the objectives, standards and roles involved need to be formulated in a political framework, to ensure that the efforts of the many stakeholders add up to the desired end result.

**Policies** are, in general terms, statements about the objectives or goals and the approach by which they are to be achieved. Policies can be formalised as policy documents, white papers, or included in formal legislation. For example, South Africa's Integrated National Disability Strategy was adopted in 1997 by the Cabinet as the government's official policy framework for disability matters, articulating a coordinated approach towards achieving equality for disabled persons across all sectors of society (see Box 2.3).

#### Box 2.3 South Africa's Integrated National Disability Strategy for coordinated government action

The INDS was developed by the Office on the Status of Disabled Persons, a Ministry established in the Office of the Deputy President in 1996. The INDS was aimed at ensuring that disability issues are integrated in all government development strategies, planning and programmes. Policy objectives and strategies were identified for 15 key areas, including public education and awareness raising, health care, communications, employment, barrier free access, and transport. For example, the policy objective for transport articulated by the INDS was:

*'to develop an accessible, affordable multi-modal public transport system that will meet the needs of the largest numbers of people at the lowest cost, while at the same time planning for those higher cost features which are essential to disabled people with higher mobility needs.'*

This objective has subsequently played a key role in shaping land transport legislation in South Africa.



**Legislation** has the force of the state behind it, and can go further than policy statements by specifying in more detail what various stakeholders can and cannot do to achieve the objectives of the policy. The term *legislation* is used to indicate a variety of legal instruments, depending on the country's political system. It includes national or parliamentary laws, decrees passed by Ministries or Heads of State, Executive or Government Orders, and local/municipal by-laws or ordinances.

The importance of enacting legislation to promote universal mobility is recognised by the United Nations: the *Asian and Pacific Decade of Disabled Persons (1993-2002)* recommended the:

*'Enactment of legislation aimed at the elimination of architectural and logistical barriers to freedom of movement for citizens with disabilities, including incentives, in order to encourage:*

- *private and public sector involvement in improving accessibility of the built environment; and*
- *facilitation of the use, by persons with disabilities, of land, air and water transport systems.'*

Legislation specifically instructing transport operators and government authorities to achieve these aims has now been adopted in countries as diverse as India (*Persons with Disabilities Equal Opportunities, Protection of Rights and Full Participation Act, 1995*), Argentina (*Ley Nacional No. 24.314, 1997*), and Japan (*Transportation Barrier-Free Act, 2000*).

## **Process of developing policy and legislation**

Although the process of developing policy and legislation varies by country, three main stages are usually evident:

**1 Mobilisation of grassroots support and support of key persons/organisations:** Many of the methods discussed under *Advocacy* (Section 2) can be helpful in mobilising wide support, including:

- Developing close relations with television and radio correspondents and print media journalists.
- Lobbying with legislators, political parties, as well as community and religious leaders.
- Submitting public petitions on access needs to the speakers of parliament or state legislative assemblies.

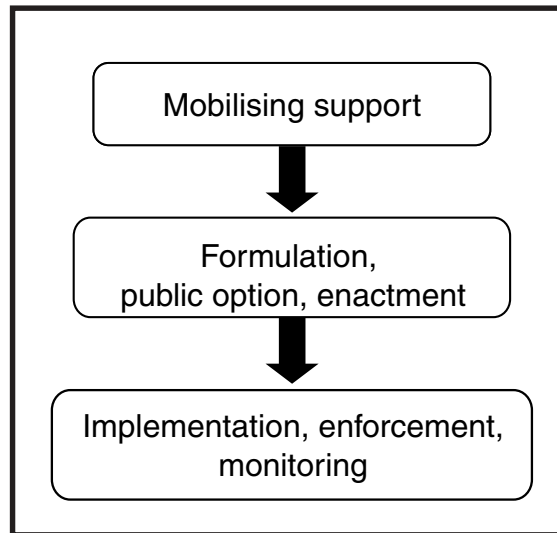

**Figure 2.6** Three stages in developing policy and legislation

- Submitting reports and memoranda on progress in the promotion of access to political, legislative, and administrative fora at all levels, including parliament, state assemblies, and chief executives (e.g. prime minister, ministers, governors, mayors and village chiefs).

**2 Formulation, public opinion and enactment:** This consists of drafting access policy provisions, obtaining public opinion about the drafts, developing more detailed legislative provisions for implementation, revision and finalisation, and enactment.

A strategy that can be very helpful for government officials is to mobilise concerned sectors of society into an **advisory committee**, including representatives of diverse disability groups, older people, children and women, administrators, professionals (e.g. architects and engineers), transport service providers, and government officials. The task of the committee should firstly be to clearly identify the access needs and barriers which need to be addressed, and then to submit specific recommendations on actions to be taken. This would help prevent a government being overwhelmed by receiving conflicting messages on what needs to be prioritised. The optimal size of the committee could be 15 to 25 people (see Box 2.4).

**3 Implementation, enforcement and monitoring:** After enactment, the real work starts with developing more detailed implementation strategies, complete with time frames and budget allocations. Section 6 gives some guidance on these issues.

Legislation should give consideration to enforcement mechanisms, such as awarding incentives to encourage observance of access policy

## Box 2.4 Mexican working group spearheads planning of a network of accessible transport



*Figure 2.7 Members of the Accessible Transport Working Group of the Coordinating Council for Mexico City's Federal District*

One of Latin America's most respected advocacy agencies is *Libre Acceso* (Free Access), an NGO in Mexico City. The founder of Libre Acceso coordinates an Accessible Transport Working Group involving municipal agencies such as the Department of Transport and Highways, the Metropolitan Transport System, the Department of Services and Construction, and the

Passenger Transport Network, with the collaboration of different social service agencies and non-governmental organisations.

The Working Group is a critical element in the development of an integrated approach towards accessibility in Mexico City. For example, the Ministry of Public Works for the Federal District required more information on the deployment of accessible buses in order to prioritise the installation of kerb ramps along the major arteries served by these lines. Representatives of different *delegaciones* (prefectures) presented reports to the Working Group on installation of kerb ramps on secondary streets that are their responsibility.

*Continued ....*

provisions, or imposing penalties in the event of non-compliance. Enforcement provisions could also include the right for individuals to take legal action if the legislation is not applied by specific authorities or private transport operators.

Mechanisms for regular review of the effectiveness of access policy provisions and/or legislation should also be included in legislation, adequately to changing circumstances, new assessments of the appropriateness of standards, and improved technologies.

### Box 2.4 (Continued) Mexican working group spearheads planning of a network of accessible transport

Currently, the Working Group participates in a planning process to authorise more than 3,500 new kerb ramps on main avenues each year, taking care to prioritise accessible pedestrian routes to the 5 newly accessible Metro stations. Over time the original fleet of 24 lift-equipped buses and trolley buses was expanded to include more than 50 accessible vehicles serving 5 bus routes which connect with each other and with the subway stations. The resulting integrated inter-modal network (pedestrian routes, buses, trolley buses, and subway) illustrates the results of involving disabled people and all other stakeholders in a planning process which maximises impact in spite of severe budgetary constraints.



Figure 2.8 Lift-equipped bus, Mexico City

Based on Cisneros-Rivero (2001). For more information, go to [www.libreacceso.org](http://www.libreacceso.org)

### Principles for developing policy and legislation

Some key principles to keep in mind when developing access policy and legislation include:

- It can take many years to develop policy and legislation. Therefore, **codes of practice** can be developed and implemented as an interim measure. Voluntary codes of practice can often contain more stringent standards than mandatory regulations.
- Access requirements can either be formulated as **stand-alone legislation** dealing solely with disability issues (as is the case with India's *Persons with Disabilities Act*), or **integrated with other policies and legislation** (such as South Africa's *Promotion of Equality and Prevention of Unfair Discrimination Act, 2000* which prohibits discrimination on the basis of disability, race, gender, and other grounds). The former approach has the advantage of being able to

give coherent and comprehensive guidance to stakeholders in many sectors whose actions need to be coordinated. The second approach has the advantage of permitting faster and more effective implementation and enforcement, through mechanisms that already exist. In many cases a combination of these two approaches will be appropriate.

- **Access legislation needs to cover a diverse range of needs**, including persons with physical, sensory and cognitive disabilities.
- All legislation, guidelines, and standards should be developed and strengthened through **consultation with people with disabilities**.
- Policy goals and legislation should recognise that true mobility requires **more than just infrastructure** with ramps instead of steps. Legislation should thus take account of all the design factors, operational factors, fare policies, and management practices which affect these four areas.
- The typical contents of access legislation could include:
  - 1 The prohibition of unfair discrimination against people with disabilities in the design of services, fare schedules, and operating procedures.
  - 2 Clauses mandating effective consultation with affected people with disabilities, in the preparation of transport projects and plans, and mechanisms for achieving this (see Section 4).
  - 3 Specific actions that need to be taken by designated stakeholders in removing barriers and facilitating universal mobility. Legislation could mandate, for instance, that all new transport interchanges and vehicles should be fully accessible, with gradual phasing in of low-cost features for existing transport infrastructure, vehicles and systems. In any country the specific actions will depend, however, on the relative importance of different barriers and the level of resources available. Sections 5 and 6 may give some guidance on this.
  - 4 Target time frames for achieving the specified actions.
  - 5 Circumstances and grounds for exemptions from the access requirements or time frames.
  - 6 A requirement for staff training to improve the services offered to all passengers, including those with disabilities.

- 7 Enforcement mechanisms for promoting compliance and dealing with non-compliance.
- 8 A monitoring mechanism for reviewing progress and updating the legislation.
- The specific ***norms and Standards to be adhered to*** in the design and operation of transport are often developed by national Standards bodies. In such cases legislation may only refer to the relevant Standard and require compliance with its provisions. There is much sharing of Standards and guidelines across countries and continents, with the result that Standards in use across the world are more alike than they are different (see the comparison of national Standards in Appendix A). Countries which have not yet developed their own Standards, or which lack the institutional capacity to undertake this task, may benefit from work done elsewhere (see for instance the practices summarised in Part III of this document).

## 4 Cooperation and consultation

---

Government officials, planners and transport operators can benefit greatly from consulting with local groups representing disabled users. Travellers with disabilities have valuable insights based on their own experiences of every day negotiating the numerous obstacles in their environment. Examples abound of well-meaning but misguided officials who attempt to make access improvements based on what they *think* disabled people need, only to create new obstacles which render their attempts worthless. For this very reason some disability groups have adopted the slogan '*Nothing About Us, Without Us*'.

Effective consultation will thus benefit everybody. Public authorities sometimes fear that consultation will delay implementation, or that others will make unreasonable demands on their budgets or resources. Consultation itself does indeed need some time, but many authorities have come to appreciate the fact that effective consultation can actually shorten the overall implementation time, if it helps them to identify key issues early on rather than having to try to change decisions or designs late in the process. The vast majority of disability groups also understand the need to work within budgets and procedural constraints, and are eager to work together with authorities to come up with viable solutions to problems.

Some pointers to promote effective consultation and cooperation between authorities and people with disabilities include:

- ***The earlier on consultation happens, the better.*** By providing designers and planners with a better understanding of people's needs from the beginning, consultation can help avoid costly rectification of mistakes later in the process. This is especially important in developing countries, where formal access standards may not be available, and 'informal' input of users may be even more valuable to identify correct design parameters of, for instance, locally applicable wheelchair or tricycle dimensions.
- ***Remember that 'disability' covers a wide spectrum of people with different needs.*** Consultation should involve people who use wheelchairs, who are ambulant disabled, people with partial sight and others who are blind, people with impaired hearing and people with cognitive impairment. This is not to say that consultation should be exclusively with disabled people, as other interested and affected groups (such as vendors, property owners, elderly people and other transport users) have as much a claim to be heard. But people with disabilities are among the only groups that could be largely *excluded*

from using the facility or service if it is designed without regard to their needs. Authorities should thus make special efforts to include them.

- **Authorities can encourage the formation of local-level access groups to consult with on access and mobility issues.** The *European Conference of Ministers of Transport (ECMT)* recommends that consultative bodies have an equitable representation of all the main interest groups: administrators, operators, vehicle equipment suppliers, and associations of people with disabilities. Elderly persons, architects, engineers, and local business could also be represented. Activities that the access groups may pursue could include:
  - Putting access on the agenda and keeping officials focused on access issues through periodic meetings. According to the *UNESCAP*, ‘a local-level access group should use publicity as a tool to encourage the emulation of examples of good practice and to generate fear of negative press coverage’ (UNESCAP, 1995).
  - Consultation with the local authority on access issues, including prioritising actions, avoiding mistakes, and monitoring results by testing design features and reporting back on compliance with operating standards.
  - Information exchange with other bodies working on access and mobility.
- Once some experience is built up with local solutions to access problems through consultation, it should be followed up with **local policy and implementation guidelines** that can be followed in the course of other work. This would be more efficient than trying detailed consultation on a multitude of individual minor projects.
- Authorities should be aware of the **use of correct language when talking with and about people with disabilities**. Language reflects the values and attitudes of a society, and people with disabilities have for a long time suffered under terminology that labels or stereotypes them, discriminated against them, and ultimately create a culture of non-acceptance of diversity. Box 2.5 contains some guidelines prepared by people with disabilities on preferred terminology in English.
- Consultation should be followed up with **direct involvement of disabled people in development and testing of features** – in other words participation. This will help ensure that whatever is provided does indeed meet its intended goals.

- After an existing facility is improved or new accessible infrastructure or services are provided, **information should be fed back to potential users with disabilities** to make sure they know about the improvements. The methods vary depending on the type and scale of changes, but could include correspondence with disability organisations, newspaper or radio announcements, or the use of leaflets or advertising.

### **Box 2.5 Some guidelines on appropriate language**

Although there are no hard and fast rules, the following list includes words and phrases that should be remembered when talking to or writing about disabled people:

- Many disabled people find the word 'handicapped' offensive, as it carries connotations of 'cap in hand'. Most people prefer the terms 'disabled person' and 'person with disabilities'.
- It is dehumanising to refer to a person in terms of a condition. Therefore do not talk about 'a spastic' or 'an epileptic'. Instead say 'he has cerebral palsy' or refer to 'a person with epilepsy'.
- Avoid words which invite pity or reinforce impressions of frailty or dependence. Examples are 'suffers from', 'affected with' or 'victim of'. Instead say 'person who has/person with/person who experienced...'
- Remember that a wheelchair represents freedom to its user. Do not say 'wheelchair bound' or describe someone as 'confined to a wheelchair'. Rather talk about a 'wheelchair user' or a 'person who uses a wheelchair.'
- Most people avoid terms like 'mentally retarded', 'insane', 'slow learner', and 'brain damaged'. Rather use 'person with an intellectual disability' or 'people with learning difficulties'.
- Remember that there are many degrees of deafness, and different methods of communicating such as lip-reading or signing. Never say 'she is deaf and dumb', but use a more accurate description such as 'she is deaf/partially deaf/deafened/hard of hearing'.

*From: 'Disability Etiquette: A leaflet for employers on meeting, interviewing, and working with disabled people', Disabled Children Action Group, Cape Town. South Africa.*

## 5 Funding

---

***Securing funding for transport projects is challenging in all developing countries because of low ability to pay amongst many passengers, and because transport budgets have to compete with other government objectives such as health care. Nevertheless, the progress that has been made in many cities in developing countries in starting to address access issues shows that funding sources can be found under the right conditions. Low-cost, incremental access improvements – such as those suggested in Part 3 of these guidelines present opportunities for maximising the impact of limited funds on the livelihoods of disabled people.***

### **Funding for pedestrian infrastructure and public transport**

***Most disabled people must use the pedestrian paths and public transport which everyone else uses.*** Whenever new infrastructure is constructed or new vehicles are bought, access features that serve most disabled passengers can be added at very low additional cost<sup>4</sup>. Experience around the world suggests that such low-cost accessibility features can be brought in over a 2 to 3 year period for approximately 1 to 2% of a combined annual municipal transport budget. Thus the incremental costs are very small. What's more, these same features tend to make trips more accessible and safer for all pedestrians and passengers.

Universal *design* features are thus usually covered in the *initial* cost of construction or vehicle procurement. *Operating* costs are *ongoing*. The funding sources for access features and accessible operation are usually the same as for all other aspects of transport. These sources include:

- Highway investment budgets, which need to include not only the building of roads, but also the adequate provision of footways (with kerb ramps at intersections) and other pedestrian facilities).

---

<sup>4</sup> *Access features that serve most disabled passengers include such low-cost features as seats at bus and minibus stops, prioritised seating in vehicles for elderly and disabled people, and the use of high-contrast paint on poles and steps inside vehicles and stations. Features that also serve people with wheelchairs tend to be more costly if they involve on-board lifts and ramps, both in terms of procurement and ongoing maintenance and training. However, operating costs for passengers using wheelchairs are negligible if all passengers board without stairs, as with many low-floor buses or Bus Rapid Transit systems with level boarding from high platforms.*

- Passenger fares, which can cover most or all of the cost depending on the circumstances, and the potential for increased patronage.
- Other revenues generated by the transport operation, especially from advertising on vehicles or income from property owned by transport agencies.
- Subsidies provided by municipal, state/provincial, or other government agencies. These revenues may come from sources such as:
  - 1 Property taxes, sales taxes, or taxes on activities such as lotteries. The creation of more passenger-friendly transport systems could be a rationale for such taxes.
  - 2 Revenues which recognise that private automobile use is often heavily subsidised by government road construction and that public transport may reduce pollution and congestion by providing an alternative to private automobiles. These revenues may include portions of fuel taxes of various kinds, road use taxes, parking taxes, parking fines, and automobile registration fees. Other taxes are more specialised. For example, some countries are looking into taxes on new development in congested urban areas to help pay for the procurement and operation of the additional public transport needed to serve such urban areas.

Another funding source for major transport and road projects is development banks such as the World Bank, the Inter-American Development Bank, and the Asian Development Bank. These and other major financial institutions need to promote access features in their loans for municipal development, poverty alleviation and highway and other transport projects in developing countries. They also need to promote the accessible operation of the transport projects that they fund.

### **Funding for door to door transport**

***Not all disabled people will be able to use regular ('fixed route') public transport served by buses or railways even where significant access improvements have been made. A significant percentage of passengers with disabilities will require door to door transport.*** Such transport may be provided by accessible taxis, accessible vans, or a variety of smaller vehicles. This type of transport is inherently more expensive than fixed route transport. This is because door to door vehicles usually transport fewer persons per hour and thus operate at a higher cost per trip. Yet door to door transport is critical to the survival and productivity of many disabled people who cannot use accessible fixed route vehicles.

In general, funding for door to door transport depends less on passenger fares and more on other revenue sources. These sources could include any of the sources used for fixed route bus or rail operations. However, additional funding sources, usually not available for fixed route operators, are used for door to door services in some parts of the world.

Here is a list of some of these sources:

- ***Cross-subsidisation from fixed-route services under concession agreements:*** As part of the concessioning of fixed route bus operators in São Paulo, Brazil, a small portion of revenues is used to subsidise a fleet of accessible door to door vans which serve disabled people unable to use the bus system. This approach requires that regulators work closely with transport operators to make sure the agreements are enforceable and followed up by all parties.
- ***Use of accessible taxis:*** In urban areas with many metered (door to door) taxis, a requirement that a percentage of taxis be accessible can reduce the cost of door to door transport. For example, Costa Rica has taken the lead in requiring that a fixed percentage of its taxi fleet be ramp-equipped. An initial 250 accessible taxis have been concessioned. In some situations, the extra fares of disabled persons have been a helpful source of revenue for taxi operators. However, unsubsidised taxi fares can make the cost for a trip prohibitive for many disabled passengers. Thus some state subsidies may be required.
- ***Subsidies provided by social service agencies:*** In many countries, social service agencies such as rehabilitation services provide transport for their clients to their services. They may also collaborate with other agencies or NGOs to provide transport for other trip purposes to a broader range of passengers with disabilities. Social service agencies sometimes contract with for-profit transport businesses to provide services for their clients.
- ***Donation of vehicles:*** In a great many cities and countries, from Mexico to Malaysia, accessible vans and other vehicles have been donated by companies, foundations, religious bodies, embassies, foreign aid agencies, wealthy individuals, and others to reduce the cost of door to door services by eliminating the major cost of procuring accessible vehicles. These donated vehicles are usually operated by social service or government agencies, but could be operated by for-profit companies under contract with such agencies.
- ***Donation of labour:*** Door to door services in some countries benefit from volunteer drivers. Such, drivers need to be properly trained, supervised, and insured at levels appropriate to their society.

- ***Individual contributions to cover the cost of door to door services:*** The feasibility of this approach varies from one country to another. In some cities, citizens can voluntarily add on a contribution, usually in a separate envelope, when paying their water or electricity bill, or a tax bill. In some cases individuals have left funds in their wills to support such services.
- ***Special funding by designated sources:*** Taxes on activities such as gambling, tobacco or liquor sales are often viewed as especially appropriate for a cause such as door to door transport for persons with disabilities.
- ***Support by businesses which benefit from the patronage of disabled and older persons:*** In some countries, such businesses help provide some of the transport costs for disabled customers. Alternatively, businesses could advertise on door to door vehicles.

## 6 Strategies for planning and implementing access improvements

---

*Once policy goals and legislative mandates for access have been adopted, strategies for on-the-ground implementation need to be formulated. Indeed, how implementation will occur needs to be in the minds of the drafters of policies and laws. The importance of proper implementation strategies is highlighted by the fact that several countries that have legislative frameworks and standards in place for achieving greater access for people with disabilities to the transport and built environment, are still struggling to move towards visible implementation.*

*This section presents some brief pointers on strategies for planning and implementing access requirements. These are aimed at implementing authorities and others involved in making access a reality in developing countries.*

### The need for coordination

The provision of any particular facility (such as a footway, transport terminal or bus shelter) consists of a number of stages of development:

Planning ► Design ► Permission ► Construction ► Maintenance & Management

These stages involve a variety of stakeholders. In more developed countries administrative procedures, guidelines and controls govern each stage. In less developed countries this process is often based more on informal actions. The vigilance of a few public officials, professional people (such as engineers and architects), and disability advocates then becomes very important to ensure good practice is followed. The important point is that awareness of good accessibility practice is necessary at all points along this chain for the end product to guarantee mobility to all potential users.

How can such coordination among multiple stakeholders be achieved? Some countries have found it useful to establish a dedicated disability desk at the national, regional or local government levels. For instance, an Office of Disability Affairs was formed in the executive branch of Mexico's national government following the election of a new President. The office is staffed by several disabled persons and has a broad mandate to institutionalise national policies to integrate disabled persons into public life, backed by legal frameworks at all levels of government. Special attention is paid to the incorporation of international norms and standards as promulgated by international agencies.

## Two strategies for incremental implementation

In most circumstances strategies that implement access regulations *incrementally* will be most acceptable to the widest range of stakeholders. An incremental approach allows authorities to work within their cyclical budget constraints. It allows planners to target interventions first where they can have the highest impact. And it allows people with disabilities to test features and solutions and to make timely corrections as new ones are rolled out.

Two basic strategies can be followed to achieve incremental implementation. They are not mutually exclusive, but complement each other:

**1. Inclusion of universal mobility requirements in all new development, redevelopment and maintenance projects.** The development of new facilities or the upgrading of existing facilities (such as rail stations, footways, bus shelters and so forth) is the best time to apply good practice to ensure the facility serves as wide a variety of people as possible, including people with disabilities.

Although it depends on the scope and nature of the project, experience has shown that access features can usually be included at a small fraction of the overall facility cost. This also applies to the acquisition of new vehicles. Similarly, when reconstruction or maintenance is performed on footways and road crossings, it may be the best time to put in kerb ramps and tactile features for pedestrians with disabilities.

This approach requires a policy to be in place at the implementing authority to check each project for opportunities to upgrade its access features, and to assess the cost implications of each option. Cost and conflicting requirements may prevent accommodation of everybody's needs, but it is necessary that acceptable compromise be reached. The major advantage of this approach is that improvements can be achieved incrementally at lowest cost.

**2. Phasing in of universal mobility features in priority areas first.** This approach firstly identifies key areas within a city at which to target access improvements, and then focuses on upgrading infrastructure, vehicle and operating features within this area to achieve coordinated universal mobility. The key areas could consist of:

- major commute corridors which would serve the highest volume of travellers; or
- local neighbourhoods complementing the corridors, and including local centres, parks, places of worship, care homes, day centres and medical facilities. Priority areas are chosen to include both origins

and destinations frequented by disabled travellers, so as to ensure a fully accessible travel chain is provided from door to door.

Improvements could thus encompass footway upgrades, kerb ramp and raised crosswalks to better serve local noncommuting and pedestrian activities.

The major advantage of this approach is that it maximises the benefit achieved for the investment, by deploying access improvements in a coordinated way.

Key areas could be improved incrementally, starting with one priority area and extending it or adding new ones as resources and experience allow. Box 2.6 describes the steps that could be followed for the incremental deployment of public transport serving areas of special importance to persons with disabilities.

### **The use of access audits**

Access audits are technical evaluations of transport facilities to systematically assess the level of barrier-free access provided by a facility. It can be used by a planning department to identify what needs to be done before designing the upgrading of a facility or area. The audit can be performed by staff themselves, but it can be particularly helpful to get local users with disabilities to participate. In either case, it is important that clear guidelines be followed to ensure the audits are performed in an equitable and knowledgeable manner using objective and measurable criteria. Guides have been published in many countries to facilitate this.

## Box 2.6 Incremental planning and deployment of accessible public transport

- 1 A city might phase in accessible services in stages to make the public transport system increasingly inclusive for people with disabilities and for older passengers. One way to start is with 'service routes' using accessible ramp or lift-equipped vans or small buses to connect key points as in the diagram.
- 2 Another alternative would be to initiate accessible services on a major bus route, using low-floor buses, lift-equipped buses, or high capacity high-floor buses (so-called Bus Rapid Transit). This should be coordinated with improving street crossings, footways and bus stops near the line.
- 3 The success of an initial accessible route may lead decision-makers to expand the system. As more priority corridors with accessible services are thus identified, upgrading of pedestrian and public transport infrastructure is guided to where it would have the greatest impact.
- 4 Accessible vans or taxis can complement the bus routes by providing door-to-door services, as is done in São Paulo, Brazil; and Kuala Lumpur, Malaysia. Ramped taxis would be especially useful for serving local airports or tourist attractions. Unless they are subsidised, these taxis would probably be serving the higher income bracket of disabled travellers in the city.

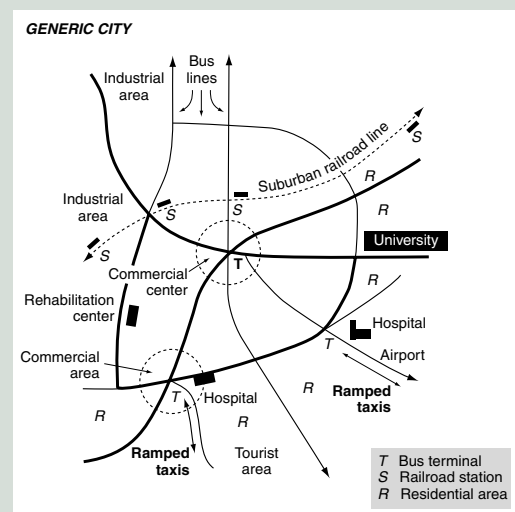
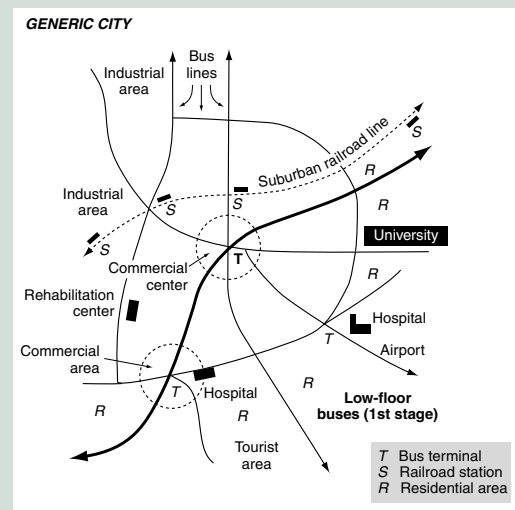
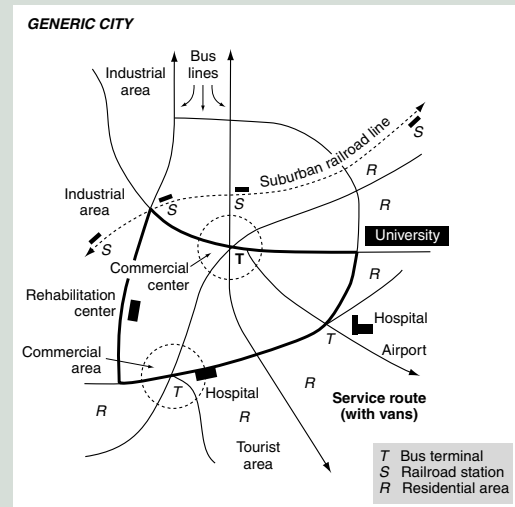

*Based on Access Exchange International (2003).*

## Box 2.7 Importance of pedestrian infrastructure

Safe and accessible pedestrian infrastructure is extremely important in developing countries. Without being able to get to a public transport stop, disabled travellers can not benefit from any amount of improvements to public transport. Many poor people cannot afford public transport at all and depend on walking for most of their travel needs. Upgrading footways and street crossings should be an early priority to enhance mobility.



*Figure 2.10 Pedestrians are forced to walk past a construction site in India because no facilities for pedestrians are provided by the contractor*



*Figure 2.9 Provision of kerb ramps benefit all users*



*Figure 2.11 A pedestrian bridge enhances safety over this busy national road in Mozambique*

## 7 References

---

**Access Exchange International (AEI) (2003).** *Making access happen: promoting and planning transport for all.* San Francisco: Access Exchange International.

**Center for International Rehabilitation (2003).** *International disability rights compendium.* Chicago.

**Cisneros-Rivero F (2001).** *The work of libre acceso in Mexico City.* 9<sup>th</sup> International Conference on mobility and transport for elderly and disabled people, 2-5 July 2001. Warsaw.

**Department for International Development (DFID) (2000).** *Disability, poverty and development.* London: DFID.

**Disabled Children Action Group. (undated).** *Disability etiquette: a leaflet for employers on meeting, interviewing and working with disabled people.* Cape Town: Disabled Children Action Group.

**Government of India (1995).** *The persons with disabilities (Equal opportunities, protection of rights and full participation) Act, 1995.* New Delhi.

**Instituto Uruguayo de Normas Técnicas (UNIT) Eds., (1998).** *Curso Básico sobre Accesibilidad al Medio Físico.* Montevideo: Instituto Uruguayo de Normas Técnicas.

**Mobility International USA (2003).** *Building an inclusive development community: a manual on including people with disabilities in international development programs.* Eugene, Oregon.

**Office of the Deputy President T M Mbeki (1997).** *Integrated national disability strategy, white paper.* Retrieved: 2003, from [www.gov.za/whitepaper/1997/disability.htm](http://www.gov.za/whitepaper/1997/disability.htm).

**Real Patronato de Prevención y de Atención a Personas con Minusvalía (2000).** *Guía para la redacción de un plan municipal de accesibilidad.* Madrid: Real Patronato de Prevención y de Atención a Personas con Minusvalía.

**Republic of South Africa (2000).** *Promotion of Equality and Prevention of Unfair Discrimination Act 2000.* Pretoria.

**SUSTRAN (The Sustainable Transport Action Network for Asia and the Pacific) (2000).** *Taking steps: a community action guide to people centred, equitable and sustainable urban transport.* Kuala Lumpur: The SUSTRAN Network.

**UNESCAP (United Nations Economic and Social Commission for Asia and the Pacific) (1995).** *Promotion of non-handicapping physical environments for disabled persons: Guidelines.* New York: United Nations.

**United Nations (1993).** *Standard rules on the equalisation of opportunities for persons with disabilities.* General Assembly resolution 48/96 of 20 December 1993. New York: United Nations.



## **Part 3: Guidelines on good access practice**



# 1 Introduction

---

***This section provides practical guidelines and solutions towards enhancing the access and mobility of people with disabilities in developing countries.***

Despite small differences in specifications across countries, what is considered good access practice is remarkably similar across the world. (The comparative table in Appendix A summarises some Standards and practices from various countries).

Developed and developing countries continue to adopt and refine their own access standards, often by exchanging ideas and experience. These guidelines do not attempt to set a universally applicable standard, nor to suggest that differences in circumstances and needs should not lead to variations in standards and their application. The purpose of these guidelines is rather to assist practitioners in parts of the world with a little or some experience of accessible transport, to know how to commence and continue addressing access problems in their areas.

These guidelines are to inform practitioners of the approaches that have been used elsewhere. They are not intended to be prescriptive. The guidelines draw on various sources covering specific aspects of the transport environment, plus case study findings undertaken during the research.

The intention is to provide guidance on design and operations as a starting point, without repeating every detail published elsewhere. Each section provides references to further standards that are easily available on the Internet or from the publisher. Circumstances may not permit all aspects of good practice to be implemented at the same time. Suggestions are therefore made as to which aspects are considered the most important as first steps to be addressed in the process of achieving full mobility for all.

## 2 Principles of good practice

---

*This section highlights some of the underlying principles which should be applied in order to ensure good mobility for everyone. Fundamentally, good practice is about addressing user abilities, needs and preferences, using technology to satisfy needs, and putting users ahead of staff convenience.*

An environment and practices that promote good mobility for all travellers will differ throughout the world. Factors as diverse as vehicle dimensions, the expectations of passengers or local weather pattern will determine whether any specific solution for access problems applies in a particular locality. But notwithstanding the diversity of possible approaches, experience across the world has shown that good access practice has four essential elements in common: it provides a travel environment that is Safe, Accessible, Reliable, and Affordable (SARA)<sup>5</sup>. By letting their work be guided by these four principles, practitioners can ensure that they are promoting improved access not only for people with disabilities, but also for everyone.

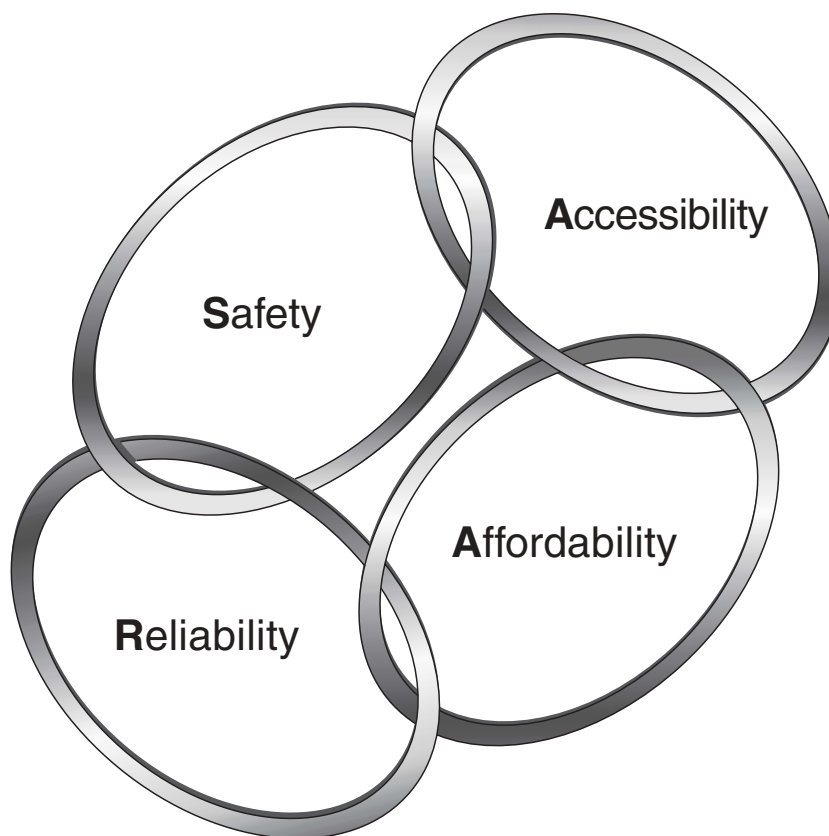

**Figure 3.1** Four basic principles of good access principles

---

<sup>5</sup> *The concept of SARA was first formulated by the UK Help the Aged Transport Council of which TRL was a member*

## Safety

Many people in developing countries face travel conditions that are not safe and secure, such as:

- pedestrians forced by unusable footways to share the road with busy traffic;
- exposure to crime when using transport or waiting for services particularly at night;
- exposure to injury when travelling inside recklessly driven buses or minibuses, or in open trucks and pickups;
- involvement in road accidents.



**Figure 3.2** In the absence of accessible footways, disabled travellers are forced to share the road with busy traffic

While these problems can affect all travellers, they can create bigger barriers for people with disabilities who may be less able to detect and respond to an unsafe situation. For instance, people walking with difficulty may be slower to avoid moving vehicles when crossing a street; or visually impaired people may be unable to detect and avoid unexpected obstacles in their path. As a result, safety concerns often prevent people with disabilities from travelling altogether.

Achieving safety improvements is often daunting, as it involves a combination of better design, operation, education and enforcement. But better safety will benefit all travellers, and not just those with disabilities. Specific principles that the practitioner can apply when addressing safety issues, particularly as they relate to the needs of disabled travellers, include:

- **Removal of obstructions that could injure travellers.** Visualise a continuous three-dimensional travel path that is clear from obstacles, such as signposts, potholes and overhanging branches. Ensure vehicle entrances, aisles and seats are free from sharp or protruding edges.
- **Provision of adequate warnings and information to prevent travellers from getting into danger.** Where obstacles cannot be removed, provide clues to inform trip makers of their existence by using highly contrasting paint or sometimes even by putting physical barriers in place.
- **Prolong the time available to accomplish certain tasks.** For example, provide longer signal settings for street crossings. Train bus drivers to keep the bus stationary until passengers with walking difficulties have reached their seat.
- **Improve security to assist vulnerable passengers.** Provide adequate lighting at stations and bus stops.



**Figure 3.3** Physical barriers such as guardrails may help to improve the safety of vulnerable users in dangerous situations such as busy street crossings

## Accessibility

Accessibility relates to the ability to access and use all parts of the transport system:

- ***Clear the way of physical barriers***, such as kerbs at street crossings. Remember that users of wheelchairs, tricycles, crutches and walking sticks, require or prefer both a step-free surface and extra space to accommodate their mobility aids.
- Many disabled people have ***reduced physical strength or stamina***. The design and operation therefore needs to promote ease of movement – including short walking distances along the most direct routes, no steep slopes, easy entry into vehicles, adequate provision of grabrails and seats to rest on.
- ***Simple design and layout*** makes facilities such as stations and pedestrian areas easier for visually impaired persons to negotiate, but also assists cognitively impaired people, visitors and occasional users.

## Reliability

Reliability relates firstly to consistency across all the elements of a journey. For a trip to be possible at all, the entire journey – including for instance the footway to the bus stop, the entrance into the bus, the journey in the bus, the exit and the footway to the destination – need to be accessible. Reliability thus requires attention to be paid to the whole trip chain.



**Figure 3.4** Use of the international symbol of accessibility, seen here at Tiananmen Square in Beijing, China (also see Box 3.9)

### Box 3.1 Reliable trip chain

The various elements in a public transport trip – from getting to or from the stop, to waiting for a vehicle, to boarding a vehicle – all need to be accessible for a reliable trip chain to be present. These figures illustrate how some of the elements at a busy minibus stop in Blantyre, Malawi, were improved as part of a project demonstrating a reliable trip chain.



*Figure 3.5 A new paved pedestrian footway is provided to ensure access for pedestrians and wheelchair users to the minibus stop. A new bus shelter, that is fully accessible to all users is under construction at the same site.*



*Figure 3.6 To enable passengers to safely cross the busy road to the hospital and the opposing minibus stop, a pedestrian crossing is installed with kerb ramps. Minibuses habitually block this section of road by drawing up over the kerb to load and unload passengers. The unsafe situation is rectified and ordered better through installation of a guardrail to prevent passengers from boarding anywhere outside the designated bus stop area.*

**Reliability over time:** If a disabled passenger can use an accessible bus to get to work in the morning, s/he must be able to trust that an accessible bus will be available again for the trip home.

**Mechanical reliability:** If a rail station is advertised as being accessible through the installation of lifts, then the lifts need to be in working order to avoid users becoming stranded.

**Information reliability:** Because accessible facilities/services are usually mixed with non-accessible ones, it becomes very important for the disabled traveller to be able to ascertain beforehand whether a specific facility or service is accessible. Consistent use of the international accessibility symbol to identify fully accessible services is useful. Disabled people often have a more limited ability to respond to unforeseen circumstances. Timely, real-time information on expected

waiting times, service changes or delays enhances their ability to make alternative plans if needed. Reliable signage in terminals or at stops benefits all users.

## **Affordability**

People with disabilities often have lower incomes, and in developing countries are often among the poorest. It is common practice in many countries to allow disabled people to travel on public transport at a reduced fare, although this may not be universally appropriate. It is also important for people needing e.g. wheelchairs, canes or crutches to get access to these mobility aids in order to have a basic level of personal mobility. Financial assistance is often needed to achieve this aim.

Affordability is also important from the transport provider or government's point of view, as budgets for transport, including access improvements, are typically very limited in developing countries. For this reason some of the lower-cost options discussed in these guidelines may be appropriate as part of an incremental access strategy.

The following sections contain additional details on how these four principles can be applied to specific design and operational situations.

### 3 Basic information

*This section provides basic information on the dimensions and requirements to keep in mind when designing facilities suitable for people with various disabilities. It is always better to provide more space rather than less. These dimensions should thus be considered as minimum requirements.*

*The dimensions provided here are based on typical values found in a range of countries. Actual designs and sizes vary from place to place. Where possible, designs should be based on locally collected data, especially of occupied wheelchair dimensions which can vary greatly from country to country.*

#### Clear ways for walking

Wheelchair users need enough space to be able to propel their chair without banging their elbows on door frames. But someone who walks with sticks or crutches also needs more space, and so too does a person carrying a lot of luggage.

Figure 3.7 shows the minimum width and height that is needed on footways and passageways. A person using two sticks or crutches needs a minimum width of 900mm. If a visually impaired person is being

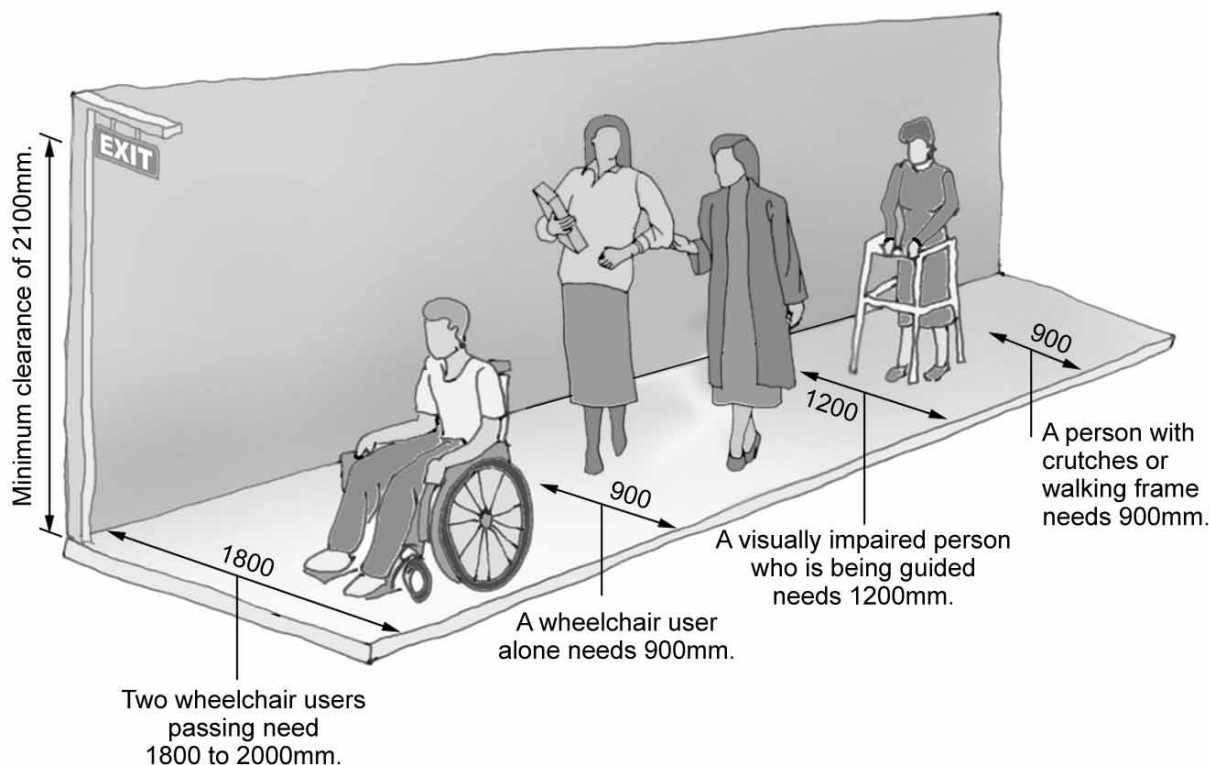

**Figure 3.7** Minimum dimensions for walkways (Adapted from Oxley, 2002)

guided by another person, a clear width of 1200mm is needed. A wheelchair user needs about 900mm clear width, and an additional 500mm is needed for a person walking alongside. A width of 1800mm to 2000mm will allow two wheelchairs to pass each other comfortably.

Unobstructed height above a pedestrian way is also important, especially for visually impaired people. Generally, this should be at least 2100mm.

## Wheelchairs

Users of wheelchairs usually require more space to move around than other disabled people. Wheelchair dimensions can vary considerably. Table 3.1 shows typical dimensions from various sources. Note that self propelled wheelchair users need another 100mm on either side to the static width, to avoid elbows hitting side walls or obstructions. A folded wheelchair is about 300mm wide and 920mm high, but actual measurements will vary with wheelchair type

**Table 3.1 Some typical occupied wheelchair dimensions**

	<i>Dimension (mm)</i>			
	<i>India (Source: Chief Commissioner 2001)</i>	<i>South Africa (Source: SABS 0370, 2002)</i>	<i>Uruguay (Source: UNIT, 1998)</i>	<i>UK (Source: PSV Accessibility Regulations, 2000)</i>
Length of wheelchair and user	1200	1300	1100 (wheelchair only)	1200
Width of wheelchair and user (static)	680	700	650 to 700	700
Height to top of user's head	1200	–	–	1350
Eye height of user	1100 to 1300	–	Minimum 1100	* 960 to 1250mm

\* *TRL survey of wheelchair dimensions*

Manoeuvring space is needed for a wheelchair user to turn corners or to turn around. Figure 3.8 shows the minimum clear space needed though the size of wheelchair will influence the space required to manoeuvre.

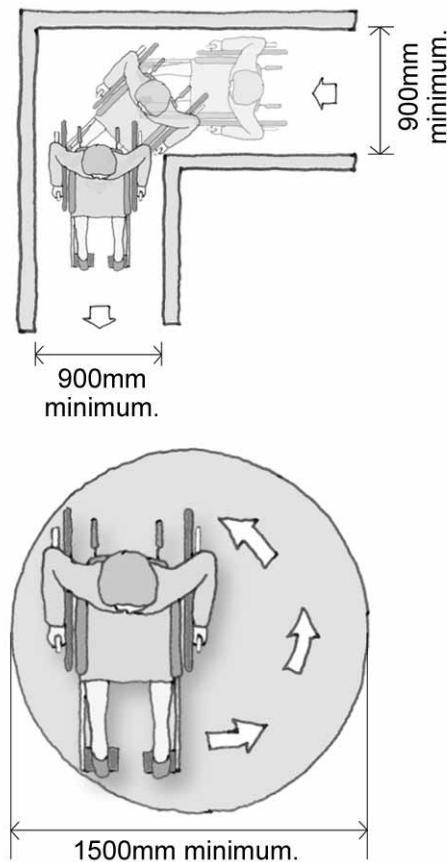

**Figure 3.8** Minimum manoeuvring space for wheelchairs (based on Office of the Chief Commissioner, for Persons with Disabilities, India, 2001)

### Walking distances

The maximum distances that frail or disabled pedestrians can walk without a rest depend on many factors, including the gradient and the smoothness of the walking surface. Research in the UK (*Leake et al., 1991*) found that only 20 percent of ambulant disabled people using walking sticks could manage to walk 180 metres without a rest. Only 40% of wheelchair users could manage this distance without a rest and a considerable proportion of ambulant disabled people could not manage more than 60 to 70 metres without a rest. Recommended values based on extensive research in the United Kingdom are as shown in Table 3.2.

**Table 3.2 Maximum walking distances**

<i>Group</i>	<i>Recommended distance limit without a rest</i>
Vision impaired people	150m
Wheelchair users	150m
Mobility impaired people without a walking aid	100m
Mobility impaired people using a stick	50m

*Source: Oxley, 2002*

## **Standing**

Standing is difficult or painful for some disabled people, particularly those with arthritis, rheumatism and back problems. Studies have shown that about 50% of people with disabilities can stand for less than 10 minutes (Oxley and Alexander, 1994). This emphasises the importance of providing plenty of seating wherever people may have to wait and along pedestrian routes.

## **Step heights**

People's ability to walk up steps affect the maximum step heights which should be provided at the entrances of buildings and other vehicles. There is an interplay between step height and the presence of handrails: many passengers find it difficult to use steps more than 200mm high, but the provision of well-positioned non-slip handrails can increase this somewhat.

## **Colour contrast**

Many people with low vision, and indeed most people at night, find it hard to distinguish street poles, steps, benches and grabrails from the surrounding area. Painting such objects with contrasting colours can greatly enhance safety and ease of use. Yellow is particularly effective in most environments.

Figure 3.9 shows some typical colours used for enhancing visibility. The basic principle is that the colour should contrast with its surroundings. Bear in mind that colours which appear to be different from each other can be very similar in terms of reflectivity, and not provide sufficient contrast (e.g. brown and green).

Apart from having the right colour, signage and information should also have the correct size and format. Section 14 describes these issues in more detail.

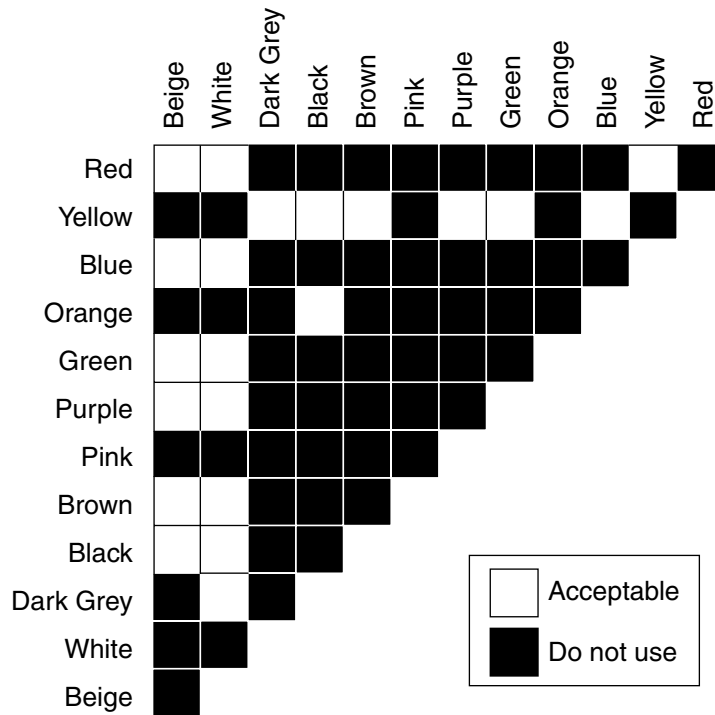

**Figure 3.9** Acceptable and unacceptable contrasts between colours  
*(Source: Arthur and Passini (1992))*

## References

**Arthur P and Passini R (1992).** *Wayfinding: people, signs, and architecture.* New York: McGraw-Hill Book Co.

**Department of the Environment, Transport and the Regions (2000).** *The public service vehicle accessibility regulations 2000.* Statutory Instruments 2000 No. 1970. London: The Stationery Office. (Retrieved: 2003, from [www.legislation.hmsso.gov.uk](http://www.legislation.hmsso.gov.uk))

**Help the Aged Transport Council (1998).** *SARA: the top four issues.* London: Help the Aged.

**Instituto de Normas Técnicas (1998).** *Accesibilidad al medio físico.* Montevideo, Uruguay.

**Leake G R, May A D and Parry T (1991).** *An ergonomic study of pedestrian areas for disabled people.* Contractor Report CR184. Crowthorne: TRL Limited.

**Office of the Chief Commissioner for Persons with Disabilities (2001).** *Planning a barrier free environment.* India.

**Oxley P (2002).** *Inclusive mobility – A guide to best practice on access to pedestrian and transport infrastructure.* London: Department for Transport.

**Oxley P and Alexander J (1994).** *Disability and mobility in London.* A follow-up to the London area travel survey. Project Report PR34. Crowthorne: TRL Limited.

**South African Bureau of Standards (SABS) (2002).** *Code of practice: road vehicles designed or adapted for use by or transporting persons with disabilities.* SABS 0370. Pretoria, South Africa.

**Stait R E, Stone J, Savill T A (2001).** *A survey of occupied wheelchairs to determine their overall dimensions and weight: 1999 survey.* TRL Report TRL470. Crowthorne: TRL Limited.

## 4 Personal mobility

---

*The term 'personal mobility' is used here to describe peoples' own independent travel modes, such as walking. As most people's journeys begin and end on foot the ability to travel short distances independently is a crucial element of the travel chain. In addition, mobility in and around the home is considered essential to fulfilling daily household tasks, enhancing a person's feeling of self-worth and sustainability. Many people with disabilities require a mobility aid such as a wheelchair, crutches or long cane to achieve personal mobility.*

*Resource constraints prevent many people in developing countries from gaining access to the mobility aids and rehabilitation services that they need. In India, for instance, it is estimated that only 5% of the estimated 10 million people who have difficulty moving about receive the wheelchairs, callipers (braces), and other devices, and accompanying therapeutic services that they need (Mobility India, 2002).*

*This section describes the different types of mobility aids available and provides examples on how affordable devices have been constructed and supplied through locally based projects.*

### Types of mobility aids

The term *mobility aids* covers a wide range of assistive devices suitable for people with various types of disability. The main types of mobility aids are:

- Wheelchair.
- Tricycle.
- Trolley.
- Crutches.
- Walking stick (cane).
- Walking frame (walker).
- Lower limb prosthesis/orthosis.
- Long cane.
- Guide cane.
- Guide dog.

### *Wheelchairs, Tricycles and Trolleys*

The three main types of **wheelchair** include:

- Self-propelled.
- Electric powered.
- Attendant propelled chairs.

Attendant propelled wheelchairs can be lighter than self-propelled wheelchairs and have smaller rear wheels. However, self-propelled wheelchairs with large rear wheels are easier to push up and down kerbs and are often used as an attendant propelled wheelchair. Attendant propelled wheelchairs are more suitable for occasional use. Table 3.3 illustrates photographs and highlights the advantages and disadvantages of different types of wheelchairs for people living in developing countries.

Hand propelled **tricycles** have been developed to enable wheelchair users to travel greater distances. However, tricycles cannot be carried in public transport vehicles such as a bus. They are suitable for people with the use of both arms and are able to use crutches or a walking stick once they reach their destination, as tricycles cannot be used indoors.

Low-level **trolleys** have been developed for use in areas where most tasks are done at ground level such as food preparation, praying and eating. However, they are unsuitable for use in pedestrian environments containing kerbs or steps.

### *Walking aids*

Walking aids include walking sticks, crutches and walking frames.

Walking aids are used to provide support, greater stability and balance for the user. A walking aid can also help maintain an upright posture and facilitate the users' stride and walking speed.

For all types of walking aids it is important to ensure the aid is the correct height for the user. If the aid is too high the user will be unable to transfer sufficient weight to the aid; and if it is too low, the user will have poor posture.

People often use walking sticks or crutches for short-range mobility within the home, school or workplace.

**Walking sticks** provide support for people who have difficulty walking. Depending on the amount of support required one or two sticks can be used. Walking sticks are usually made out of wood or metal and come with a variety of handles:

- Crook handles are the most common and can be hooked over the arm when not in use but do not allow the same amount of grip as other types.
- For those who require more stability, a swan neck handle or offset handle will spread the users' weight centrally over the base of the stick.
- Contoured handles can be more comfortable to use as they spread the pressure over a wider area of the palm.

These latter types of handle tend to be more expensive to produce and are less widely available in developing countries.

The two main types of **crutches** are underarm crutches and elbow crutches.

Crutches shift the force of upright movement from the legs to the upper body. They are more manoeuvrable than a walking frame and can be used on steps and stairs. Crutches should be used in pairs.

**Walking frames** are the most stable walking aid and suited to indoor use, although good pedestrian infrastructure also make them usable outdoors. Walking frames tend to be difficult to manoeuvre and cannot be used to go up and down stairs. Wheels can be fitted to some frames to make them more manoeuvrable.





#### *Lower limb prostheses and orthoses*

A lower limb prosthesis (artificial limb) or orthosis (limb support, such as a calliper or brace) can enable some people to walk without the use of crutches or a walking stick, while others use a prosthesis or orthosis in conjunction with another walking aid. Prosthetic limbs and orthosis are normally distributed through rehabilitation service centres as they require specialist assessment and fitting by trained technicians.

#### *Long and guide canes*



Visually impaired people can be trained how to use a long or guide cane to enable them to travel independently. A long cane is used to help the user scan the local environment and identify hazards such as the edge of the kerb and step depths. A long cane should reach above the user's sternum (breastbone) when the user is standing upright and the cane tip is touching the ground between their legs. The length of the user's walking stride will also affect the length of cane required. Figure 3.10 shows a long cane user following a guidance path in China.

**Table 3.3 Advantages and disadvantages of different types of wheelchair**

<i>Type of wheelchair</i>	<i>Advantages</i>	<i>Disadvantages</i>
<p>Manual – four wheel</p> 	<ul style="list-style-type: none"> <li>● Can be used indoors and outdoors.</li> <li>● Numerous designs.</li> <li>● Can be attendant propelled (if handles provided).</li> <li>● Wheelchairs with collapsible frames can be stored folded.</li> </ul>	<ul style="list-style-type: none"> <li>● Less suitable for rough terrain, especially those manufactured for use in developed countries.</li> </ul>
<p>Manual – three wheel</p> 	<ul style="list-style-type: none"> <li>● Suitable for rural or mountainous areas.</li> <li>● Can be attendant propelled (if handles provided).</li> </ul>	<ul style="list-style-type: none"> <li>● Less suitable for use indoors.</li> </ul>
<p>Attendant propelled</p> 	<ul style="list-style-type: none"> <li>● Can be used by people unable to propel themselves (e.g. children or those with no upper limbs).</li> <li>● Can be stored folded.</li> </ul>	<ul style="list-style-type: none"> <li>● User cannot self-propel.</li> <li>● Difficult to manoeuvre over rough ground and kerbs.</li> </ul>
<p>Electric powered</p> 	<ul style="list-style-type: none"> <li>● Less tiring for user so can travel further.</li> <li>● Can be used by people unable to propel themselves.</li> </ul>	<ul style="list-style-type: none"> <li>● Expensive.</li> <li>● Heavy.</li> <li>● Difficult to transport in vehicles.</li> <li>● Most models manufactured in developed countries.</li> <li>● Difficult to obtain spare parts/batteries.</li> </ul>

*Continued ....*

**Table 3.3 (Continued) Advantages and disadvantages of different types of wheelchair**

<i>Type of wheelchair</i>	<i>Advantages</i>	<i>Disadvantages</i>
<p>Special seating for children</p> 	<ul style="list-style-type: none"> <li>● Can be modified as the child grows.</li> </ul>	<ul style="list-style-type: none"> <li>● Individual specification.</li> </ul>
<p>Tricycle</p> 	<ul style="list-style-type: none"> <li>● Can travel longer distances.</li> <li>● Suitable for rough terrain or mountainous areas.</li> <li>● Available as a stand alone product or trike attachment for some wheelchair models.</li> </ul>	<ul style="list-style-type: none"> <li>● Not suitable for use indoors.</li> <li>● Cannot be carried safely in vehicles.</li> <li>● Heavy.</li> </ul>
<p>Trolley</p> 	<ul style="list-style-type: none"> <li>● Useful for performing ground level tasks.</li> </ul>	<ul style="list-style-type: none"> <li>● Difficult to manoeuvre.</li> <li>● Too low for use in most pedestrian environments.</li> <li>● Cannot be carried safely in vehicles.</li> </ul>

*Photographs courtesy of Motivation, TRL Limited, UNESCAP*



**Figure 3.10** Long cane user following a guidance path  
(Source: Access Exchange International)

Guide canes are shorter than a long cane reaching just above waist level when the user is standing upright with the tip of the cane touching the ground between their legs. The guide cane can be used in a diagonal position across the lower part of the body for protection, or used to check for kerbs and steps by using a scanning technique. Long and guide canes should not be used as a means of support.

#### *Guide dogs*

In some countries, such as South Africa, dogs are trained to help guide visually impaired people around the local environment. The training is expensive to provide and is undertaken over a lengthy time period.

## Basic principles

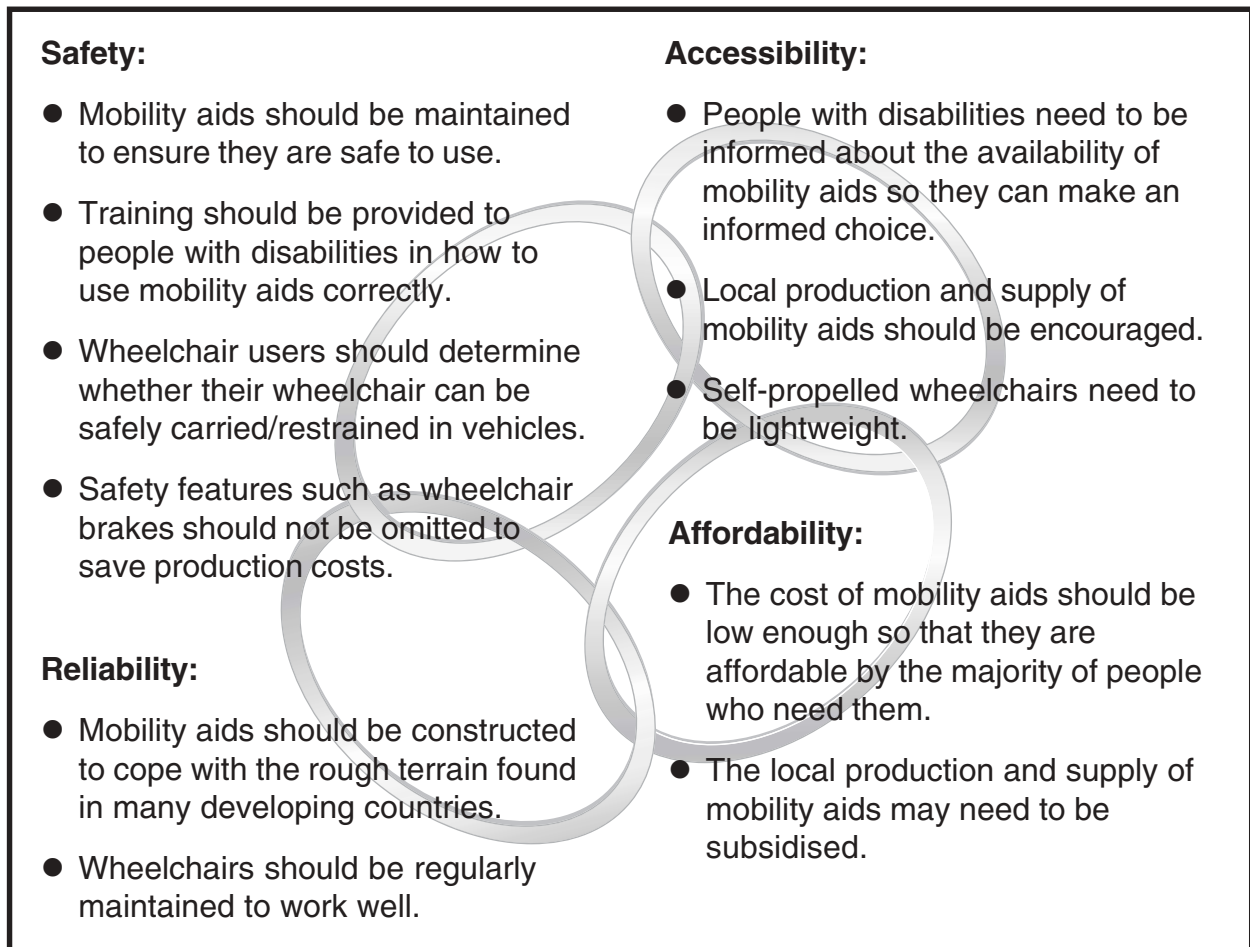

## Good practices

### *The role of Government*

Rule 4 of the United Nations Standard Rules on the Equalisation of Opportunities for Persons with Disabilities covers the development and supply of assistive devices for people with disabilities (UN, 1993). The Rule highlights that assistive devices are required to achieve equalisation of opportunities and enable people with disabilities to live more independently. The document encourages Governments to ensure the provision and accessibility of assistive devices for people with disabilities, including financial accessibility. Governments should consult with disabled people about the provision of services and mobility aids.

A report by the United Nations' Economic and Social Commission for Asia and the Pacific (UNESCAP) on the production and distribution of assistive devices for people with disabilities includes a sample national policy and plan (UNESCAP, 1997). It suggests that:

- Governments co-ordinate assistive-device services within the country by encouraging co-operation between government agencies, NGOs, industry, academic and research institutions.

- Funding should be made available to support the development, production and distribution of assistive devices. It also suggests that the cost of purchasing assistive devices should be covered or subsidised.
- Regulations and procedures should be adopted when necessary to ensure quality control.
- Training for technicians should be provided or supported.
- People with disabilities should be included in the development of national policy.

It is important for disabled people to be consulted at all stages about the design, production and supply of mobility devices.

#### *Locally made devices*

For many people living in developing countries, only a limited range of poor quality wheelchairs is usually available. Mass produced wheelchairs in developing countries are usually designed for use in hospitals and are limited in range and size making them unsuitable for constant use. People frequently have to travel long distances to obtain a mobility device, as their supply is limited to a few locations. Local production thus provides people with disabilities with greater access to mobility aids, which are more appropriate to their needs. In the absence of trained technicians, rehabilitation self-help services may also be an option (*Werner, 1987*).

#### *Local workshops*

A number of successful workshops have been established in developing countries. These workshops often employ local people, including those with disabilities, to produce and distribute mobility aids. The mobility aids are constructed out of locally available materials so they can be easily repaired and maintained. Community workshops can also produce custom-made devices to meet individuals' needs and repairs. The workshops provide employment for people with disabilities and increase their opportunities of employment elsewhere by teaching various skills.

A number of NGOs provide training for technicians (see *Where to start* below) and assistance in setting up a workshop.

They provide advice on:

- The equipment needed to build mobility aids.
- Appropriate designs.



**Figure 3.11** A workshop in Malawi making wheelchairs and other devices also provides employment for people with disabilities

- Training in metal work skills etc.
- Sourcing local materials.
- Marketing services to other people with disabilities and rehabilitation services.
- Finding local partners.
- Gaining support of business and government.

Funding is required to establish new production workshops and provide business skills training, loans and partial subsidies for consumers.

#### *Mass production in developing countries*

Some components of mobility aids such as castor wheels for wheelchairs and knee joints are amenable to large-scale production.

Recently, the UK based NGO *Motivation* has supported WorldMade, a project which aims to establish an international production centre of low cost, high quality wheelchairs designed for use in developing countries.

### *Imported devices*

A number of projects in developed countries help provide mobility aids for people living in developing countries by collecting mobility aids that are no longer used. These mobility aids are then repaired and distributed through local organisations in developing countries. Some mobility aids, such as prosthetics, are dismantled and the parts used in local workshops.

Such recycling schemes do benefit people with disabilities who might otherwise not be able to afford a mobility aid. However, some commentators (see for instance *Hof et al., 1993*) suggest that imported devices sometimes have problems of not being consistently available, of being difficult to repair; and of being less suited to the local terrain (e.g. too heavy to push). Imports from other developing countries thus tend to be more suitable than those from developed countries.

### *Wheelchair design guidelines*

Wheelchairs used in developing countries need to withstand rougher terrain and often need to be repaired more frequently than those used in developed countries. *Whirlwind Wheelchairs International (Hof et al., 1993)* suggests that wheelchairs should meet the following criteria:

- Individual fit for minimum chair width and efficient hand propulsion.
- Precise control at moderate speeds.
- Manoeuvrable over obstacles.
- Safe transfer in and out of the chair.
- Compact size for easy manoeuvring in tight spaces.
- Lightest possible weight for ease of propulsion and ease of lifting.
- Exceptional durability under rough urban and rural use in all types of weather.
- Low cost, both initially and over the life of the chair.
- Efficient production by persons with disabilities with a minimum of capital investment.
- Easily customised for people with special requirements.
- Locally repairable using the skills and materials now available in village settings.

It is important that the wheelchair provides a stable seating base. This makes it easier to transfer to and from the wheelchair and for the user to sit unaided in the wheelchair. A seat that is too large or small exposes the user to a high risk of pressure sores as their body weight will not be distributed evenly over the seat or be supported adequately. Wheelchairs that can be adjusted for the user are more effective.

*UNESCAP (1997)* encourages the networking of designs and exchange of products, components and experience of running workshops. A number of wheelchair and construction guides are listed in the references below.

### *Mobility assessment*

Mobility assessments are helpful to ensure that a disabled person has the most suitable mobility aid for their condition. This is often undertaken by a therapist, such as an occupational therapist, physiotherapist, or in some cases a nurse, who has undergone training in needs assessment and will be linked to rehabilitation services.

Regular assessment is required to ensure continued appropriateness of mobility aids, especially for children.

### *Mobility training*

People with disabilities require training in how to use mobility aids to enable them to travel independently.

For people with a vision impairment, mobility training teaches them how to use sensory cues and landmarks so they can orientate themselves in the environment. They are also taught how to use a Long cane to check for hazards and the depth and position of steps and kerbs.

### *Funding*

The cost of mobility aids should be kept at a level that is affordable for people who need them. In some countries grants are available for people with disabilities with low incomes to purchase mobility aids.

## **Where to start?**

A number of resources are available to support local efforts at improving the availability and quality of mobility aids. Some of them are:

- Boeijen van A G C, Flier P, Oldenkamp I, Toetenel O, Vermeulen R and Verweij J (1995). *Tricycle Production Manual*. Delft: CICAT/FIDE

- BOND (British Overseas NGOs for Development). Directory of UK based NGOs working in developing countries with people with disabilities. [www.bond.org.uk](http://www.bond.org.uk)
- Guide Dogs for the Blind Association, South Africa. <http://www.guidedog.org.za/>
- Handicap International – funds training for people involved in rehabilitation in association with local partners such as Mobility India [www.handicap-international.org.uk](http://www.handicap-international.org.uk)
- Whirlwind Wheelchair Network – Database of workshops and projects. [http://whirlwind.sfsu.edu/general\\_info/database/db4-99.html](http://whirlwind.sfsu.edu/general_info/database/db4-99.html)
- Jaipur Limb Campaign – train local people how to manufacture and fit low cost artificial limbs. [www.jaipurlimb.org](http://www.jaipurlimb.org)
- Motivation and TTCOT – Wheelchair Technologists Training Course [www.motivation.org.uk](http://www.motivation.org.uk). See also <http://www.motivation.org.uk/miro/index.htm> for a database including drawings and technical information on wheelchair production.
- POWER – train local people to become prosthetists and produce artificial limbs [www.power4limbs.org](http://www.power4limbs.org)
- RESNA 2000 Conference proceeding includes a number of useful articles about wheelchair design and production. Available from [www.resna.org](http://www.resna.org)

## References

**Hof H, Hotchkiss R and Pfaelzer P (1993).** *Building wheelchairs, creating opportunities: collaborating to build wheelchairs in developing countries.* Technology and Disability, Spring 1993, vol. 2, no. 2.

**UNESCAP (1997).** *Production and distribution of assistive devices for people with disabilities. Part One: Regional Review.* New York: United Nations.

**United Nations (1993).** *Standard rules on the equalisation of opportunities for persons with disabilities.* General Assembly resolution 48/96 of 20 December 1993. New York: United Nations.

## Further references

- Information on Community Based Rehabilitation (CBR) and assistive devices.
- IDDC – International Disability and Development Consortium – information about NGOs working in developing countries on disability issues and topics such as CBR. (Retrieved: 2003, from [http://www.iddc.org.uk/dis\\_dev/topics.shtml](http://www.iddc.org.uk/dis_dev/topics.shtml))
- Mobility India, Bangalore, India. (Retrieved: 2003, from <http://mobilityindia.org>)
- RESNA Special Interest Group 17 – International Assistive Technology. (Retrieved: 2003, from <http://www.egr.msu.edu/~haddow/sig17/>)
- Source International Information Support Centre databases. (Retrieved: 2003, from <http://www.asksource.info/databases.html>)
- Werner D (1987). Disabled village children: a guide for community health workers, rehabilitation workers and families. California: The Hespian Foundation.
- World Health Organisation – Disability and Rehabilitation publications. (Retrieved: 2003, from <http://www.who.int/ncd/disability/publications.htm>)

## 5 Pedestrian footways

---

*Pedestrian footways are any areas primarily used by pedestrians. They can be adjacent to roadways (then also called sidewalks or pavements), or away from the road (when they are also known as footpaths). Providing accessible footways in the right places is a fundamental aspect of promoting mobility for everybody, as almost every trip starts and ends on foot. Furthermore, very poor people with disabilities often have no means of using public transport, and would particularly benefit from having access to a safe and accessible footway on which to travel to undertake livelihood activities. Well designed and maintained footways can benefit people with a variety of disabilities, including users of wheelchairs and tricycles, by providing a safer alternative to having to share the roadway with fast-moving traffic.*

### Basic principles

#### **Safety:**

- Level and smooth surface.
- Clearly separated from vehicular traffic.
- Adequate clear width and height clearance.
- No open utility covers, streetworks.
- Good street lighting.

#### **Reliability:**

- Footway should provide uninterrupted accessible way between designated points.

#### **Accessibility:**

- Remove obstacles, including parked vehicles, from the footway.
- Gradients not too steep.
- Adequate resting places.
- Simple layout and adequate clues to visually impaired people.

#### **Affordability:**

To the provider:

- Minimise costs by including access improvements in regular maintenance and new construction.
- Maximise impact by upgrading highly used pedestrian areas first.

## Good practices

### *Surface quality*

Firm, even surfaces are important to people using sticks or crutches or wheelchairs, or people walking with difficulty. The removal of obstacles like potholes, tree roots and storm water drains crossing the walkway will do much to make it safe and usable. Torrential rain in many developing countries wreak havoc with unpaved surfaces – it is therefore best to pave pedestrian facilities with asphalt or concrete. If brick paving is used care should be taken to lay it evenly. Lower cost surfacing such as compacted crushed rock or unpaved compacted earth may be an option in footways with very low usage, but these are typically not accessible to persons with wheelchairs unless they are kept smooth, compacted or otherwise stabilised. Where grates over storm water drains cannot be kept out of the footway, they should be perpendicular to the direction of travel to prevent wheelchairs' wheels from falling through.

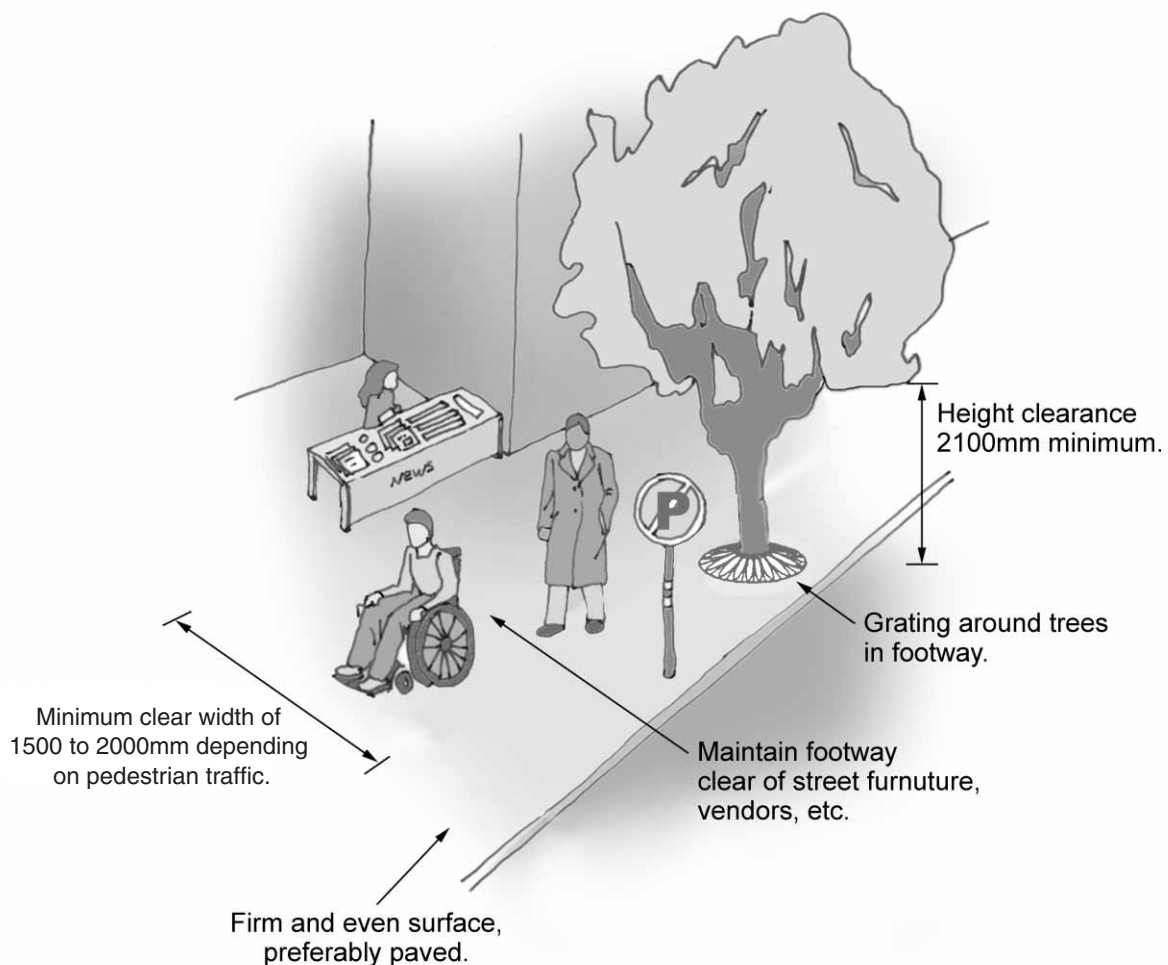

**Figure 3.12** Dimensions for footways, sidewalks, or pavements

### *Width*

Footways and paths should ideally be at least 2000mm wide in areas with moderate to high pedestrian traffic. This width will allow two wheelchairs to pass each other comfortably. Where this cannot be achieved, or in areas with light pedestrian traffic, a width of 1500mm is regarded as the minimum acceptable, giving enough space for a wheelchair user and a walker to pass each other. Some guides allow widths of 1200mm over short distances if inadequate space is available. Where possible these widths should be maintained consistently, even behind bus shelters and in front of shop fronts. This clear space should be maintained free from traders and hawkers who will inevitably use the space for marketing foods and other goods and services and from squatters and migrants using the footway as a 'home'. Where possible, local authorities should seek to find alternative locations for hawkers and squatters which meet their needs, while enabling all pedestrians to be mobile.

### *Height*

Clearances of at least 2100mm should be provided to prevent visually impaired people from hitting overhanging branches or signs. Where this is not possible (for instance at an overhead pedestrian bridge) a physical barrier should be used to warn blind or partially sighted pedestrians.

### *Simplicity of layout*

Footways should be designed as straight and simple as possible, with benches, poles, rubbish bins etc. to one side, out of the way. This aids



**Figure 3.13** Footways are rendered inaccessible by vendors and squatters blocking them

visually impaired people. Changes in slopes and crossfalls, for instance when the footway crosses a vehicle driveway, should be gradual and kept to a minimum. Frequent changes make it more difficult for people who are walking, as well as those using wheelchairs.

### Box 3.2 Public spaces and markets



*Figure 3.14 Ramps in market areas can serve both traders moving goods and their customers*

Having barrier-free access to public spaces such as market areas, public squares and parks may significantly enhance some people's ability to do their own shopping, business, or leisure activities. In some places pedestrian crowding and unregulated vending may pose significant challenges to making public places safe, accessible and reliable, but good design and enforcement will start to benefit many people, including shoppers with baggage and vendors with trolleys or carts.

Many of the good practices discussed under pedestrian ways (Section 5) and transport facilities (Section 8) can be applied to public spaces. Pedestrianised areas should also have level surfaces, and at least one step-free path (including ramps where needed) between different levels. Ground markings (especially with tactile features) can be used to mark out a clear path free of obstructions. This will benefit disabled people who need additional space to move, and also provide guidance to visually impaired people who may find it difficult to navigate through large, open spaces. Where public spaces include boarding areas for public transport, including rickshaws, the guidelines in Sections 7, 8 and 9 should be followed.

#### *Tactile guideway*

Sometimes visually impaired people need guidance in using a pedestrianised area, especially if the footway crosses larger open spaces where the usual guidance given by the edge of the footway or building base is not available, or when pedestrians need guidance around obstacles. A continuous tactile guideway in the direction of pedestrian travel, which has a different texture to the rest of the footway, can provide this guidance. The different texture can be followed by people using a Long or guide cane, and can also be detected underfoot

by others with low vision. Research has shown that a height of about 5mm for the raised part of the surface is sufficient for almost all visually impaired people to detect, without causing too much discomfort for other pedestrians. Tactile guideways should however be used sparingly as they can hinder wheelchair users and other pedestrians.

Tactile guideways can take the form of pre-fabricated guide blocks with raised flat-topped bars which can also be in a contrasting colour. In Mexico City and Buenos Aires subway stations, tactile guideways incorporating grooves cut in the floor have been used, but these are less common.



**Figure 3.15** Tactile guideway with colour contrast in use in China

#### *Tactile warnings*

Where the path leads to a dangerous situation (such as a street crossing – see Section 6) a tactile warning should be used to warn visually impaired pedestrians. This can take several forms, e.g.

- Pre-cast concrete blistered paving or ‘bubble blocks’ are used to transition paved footways into street crossings at kerb ramps (see Figure 3.16).



**Figure 3.16** Tactile warnings on kerb ramps used in South Africa

The meaning of warning surfaces needs however to be well publicised.

#### *Gradient*

Guidelines from many countries agree that a gradient of 8% (1 in 12, or 1 metre rise to every 12 metres horizontal distance) is the absolute maximum that may be used in pedestrian areas. Anything greater than this causes difficulties for manual wheelchair users and may cause them to topple over. Steeper slopes than 8% can be managed by some wheelchair users, but only over very short distances (see Table 3.4). In fact, any footway or ramp that is steeper than 5% should provide level areas as resting spots every 10 metres or so.

Changes in slope should be gradual enough that wheelchairs do not become stuck. Crossfalls should only be provided where absolutely necessary for drainage purposes. For persons using wheelchairs a flat crossfall is often more important than a flat gradient. Where crossfalls need to be provided, these should never be more than 2.5% (1 in 40). Anything steeper than this makes it difficult for a wheelchair to steer in a straight line.

**Table 3.4 Gradients for footways and ramps**

<i>Gradient of footways or ramps</i>	<i>Recommended use</i>
10 per cent (1 in 10)	Only over very short distances (1000mm or less), such as kerb ramps.
8 per cent (1 in 12)	Maximum slope for general use.
5 per cent (1 in 20)	Preferred slope where possible.

*Source: Based on Oxley, 2002*

To ensure that users of wheelchairs, tricycles, crutches, pushcarts etc., can use the walkway, small ramps should be installed in all places where there are changes in level. Section 6 provides more information on kerb ramps and street crossings.

#### *Maintenance*

To preserve usability and continuity of the walkway, it is critical that it be kept clear of rubbish, dirt, street works, parked cars and other obstacles. Street works (especially when left unattended) should be guarded by a continuous, rigid barrier (not plastic tape) along the entire perimeter. These can be made at very low cost from timber painted in contrasting colours (Figure 3.17).

#### *Footbridges and subways*

New footbridges and subways should be built with ramps to allow everybody to use them. The guidelines on ramps and handrails in Section 12 should be followed.

#### *Rest areas*

As mentioned in Section 3, pedestrians with disabilities need to rest at reasonably frequent intervals. Along frequently used pedestrian ways seating should be provided at regular intervals. As with all street furniture, seating should be placed next to the footway without obstructing it, and painted in contrasting colours. See Section 8 for more information on seating.

#### *Guardrails*

Where there is a large drop at the edge of a footway, guardrails could be provided. Guardrails should be at least 1100mm high and painted to contrast clearly with the surroundings.

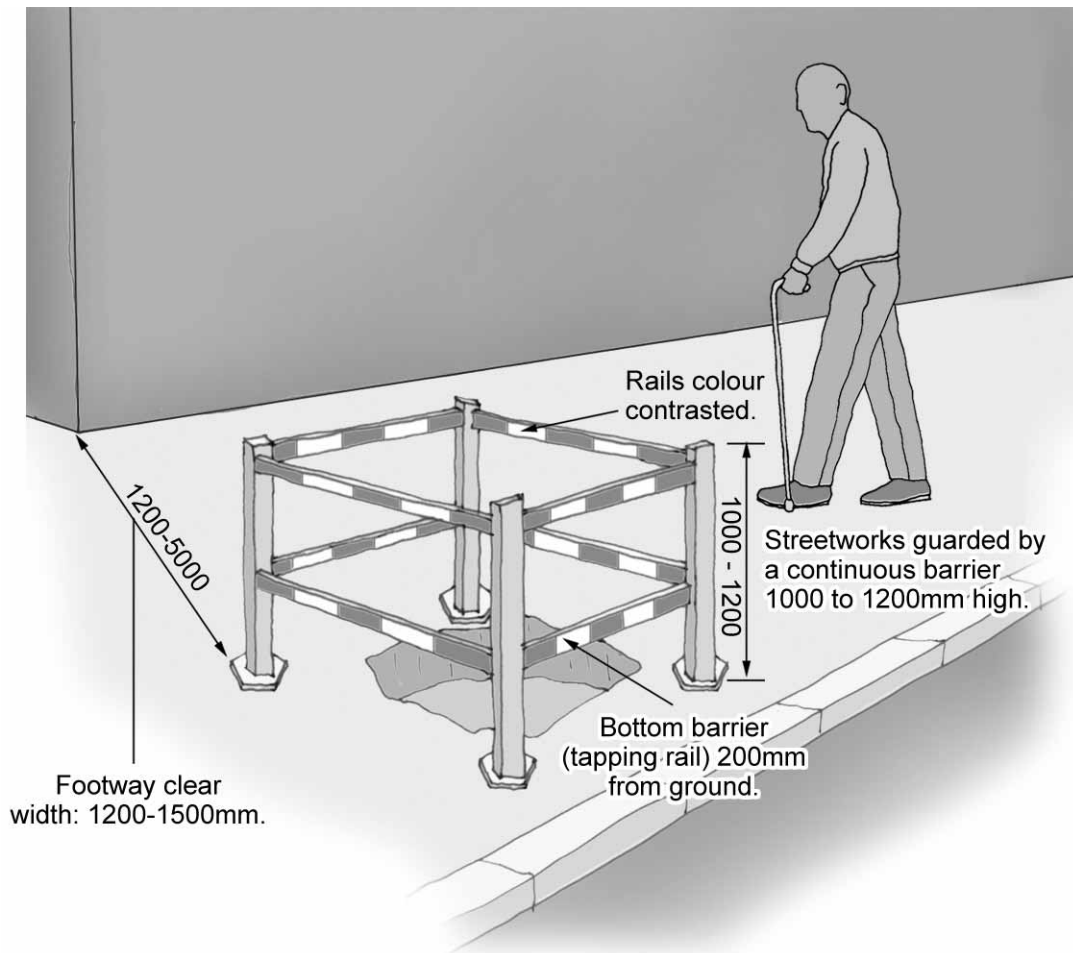

**Figure 3.17** Street works (Based on Oxley, 2002)

### Where to start?

The most common barriers to safety, accessibility and reliability of pedestrian footways and footpaths are bad surface quality and obstructions in the form of poles, kerbs, parked vehicles or traders. First steps in providing adequate pedestrian facilities should therefore include:

- Surfacing footways with an all-weather material (asphalt or concrete).
- Installing kerb ramps where the footway crosses streets, driveways and so forth.
- Ensuring that street signs and street furniture are located to provide an adequate clear width and height that is continuous along the footway.
- Ongoing enforcement to keep parked cars, vendors, and rubbish out of the clear width.

Of course this standard cannot be achieved everywhere at once. But an Authority can start by taking the following steps:

- When doing regular maintenance, upgrading or construction of roads and footways, ensure that accessibility guidelines are followed. Access improvement can be achieved in this way at minimal cost.
- Start by identifying high priority pedestrian routes used by many people (including many people with disabilities), for upgrading first. Bear in mind what the origins and destinations of people are along this route, in order to ensure that reliable, uninterrupted accessibility is provided between these points. Providing a footway only on one side of the street and later completing the other side may be adequate as a start, although it is generally desirable to provide footways on both sides of streets used by pedestrians.



**Figure 3.18** A pavement level with the carriageway but separated from it with a low kerb is easily constructed and provides access to all users

### Further references

- Access Board (2002). Americans with Disabilities Act Accessibility Guidelines for Buildings and Facilities (ADAAG). (Retrieved: 2003, from [www.access-board.gov/adaag/html/adaag.htm](http://www.access-board.gov/adaag/html/adaag.htm))
- Department of Transport (2002). Pedestrian and Bicycle Facility Guidelines (Draft). Pretoria, South Africa: Department of Transport.
- Department of the Environment, Transport and the Regions and the Scottish Office (1998). Guidance on the use of tactile paving surfaces. London: Mobility Unit, Department for the Environment, Transport and the Regions. (Retrieved: 2003, from [www.dft.gov.uk](http://www.dft.gov.uk))

- European Conference of Ministers of Transport (1999). Improving transport for people with mobility handicaps: a guide to good practice. Paris: OECD.
- Oxley P 2002. Inclusive mobility – a guide to best practice on access to pedestrian and transport infrastructure. London: Department for Transport. (Retrieved: 2003, from [www.dft.gov.uk](http://www.dft.gov.uk))
- UNESCAP (United Nations Economic and Social Commission for Asia and the Pacific) (1995). Promotion of non-handicapping physical environments for disabled persons: guidelines. New York: United Nations

## 6 Street crossings

---

*Street crossings are important elements of the pedestrian environment. Disabled pedestrians are particularly vulnerable because they often move more slowly, or are slower to perceive and react to danger than other pedestrians. All pedestrians – and disabled pedestrians, children and elderly people in particular – can benefit greatly from well-marked and well-designed crossings. By channelling pedestrians into designated points, crossings make drivers more aware of the presence of pedestrians. Street crossings can be uncontrolled (with no traffic signal) or controlled (with a traffic signal). Signals are usually only warranted if vehicle and pedestrian volumes are high enough, such as on busy roads or near schools and hospitals. In all cases it is crucial to observe good practice to promote safety, accessibility and reliability.*

### Basic principles

#### **Safety:**

- Crossing clearly marked on the road.
- Advance warning to vehicles to stop or giving priority to pedestrians.
- Warning to visually impaired pedestrians that they are approaching street crossing.
- Method of informing visually impaired pedestrian when it is safe to cross.
- If signalised, keep traffic stopped long enough to allow slow walkers to cross.
- Good street lighting.

#### **Reliability:**

- Warnings, information and traffic signals well-maintained and in good working order.

#### **Accessibility:**

- Kerb ramps providing level surface from footway to road.
- Minimise crossing distance, for instance by extending kerbs across parking lanes or installing centre islands.

#### **Affordability:**

##### To the Provider:

- Minimise costs by installing at least kerb ramps and warning surfaces at all newly constructed or upgraded crossings.
- Maximise impacts by prioritising crossings with high pedestrian volumes.

## Good practices

### Crossing design

The design of street crossings should aim for simplicity and consistency. The recommended minimum width of a street crossing is 1200mm (Figure 3.19). Where the pedestrian has to cross many lanes of traffic, centre islands can help to reduce the distance. Centre islands should be at least 1500mm wide to cater for wheelchairs, and be cut through to the level of the crossing.

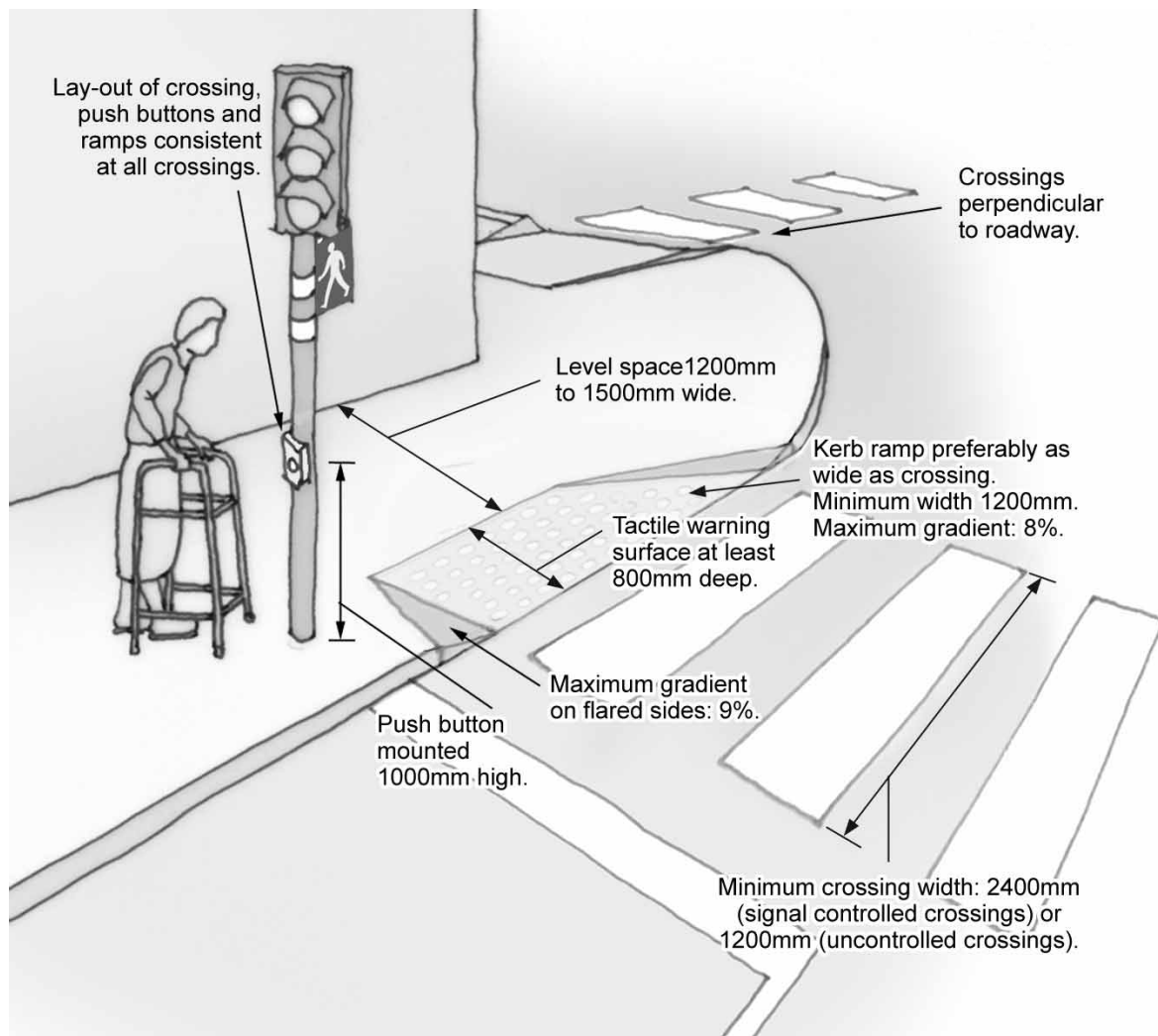

**Figure 3.19** Good practice for street crossings (*Based on Oxley, 2002*)

The safety of a crossing can be significantly improved by extending the footway out across any parking lanes (Figures 3.21 and 3.24). This has the dual purpose of reducing the width of roadway to be crossed, and slowing down vehicular traffic. Crossings should be laid out with ample space, especially at the top of the kerb ramp to allow easy passage for pedestrians who are not crossing the road (see kerb ramps below).

It is important to design crossings following consistent patterns, to enable visually impaired users to orientate themselves easily. For instance, the traffic signal pole should always be on the left (or the right) of the crossing; and the push button at the same height (about 1000mm above the ground).



**Figure 3.20** Pedestrian crossing opposite hospital entrance with newly installed kerb ramps, cuts in central island and road marking installed as part of the demonstration project in Maputo, Mozambique (*Following the improvements, a huge increase in the proportion of elderly and ambulatory disabled people using the crossing was observed.*)

### *Kerb ramps*

Kerb ramps (also known in some countries as dropped kerbs, bevelled kerbs, or kerb cuts) should be used wherever footways cross roads, pavements, medians, or other raised surfaces. The recommended dimensions for kerb ramps are shown in Figure 3.19. The ramp should have a minimum width of 1200mm, although some guidelines allow as little as 900mm to allow one wheelchair to just fit. At crossings, the ramp should optimally be as wide as the crossing (minimum 2400mm), especially in new construction where the cost is minimal. Kerb ramps should be free of obstructions such as signposts and traffic lights. They should also not project into the roadway where they would obstruct traffic.

Where possible the bottom of the ramp should be flush with the roadway, as even a small 'lip' of more than 6mm can cause the front wheels of a wheelchair to swivel sideways and bring the wheelchair to an abrupt and dangerous stop.

The landing at the top of the kerb ramp is an important component of the ramp. It provides a level area for persons to bypass the kerb ramp, as well as for wheelchair users to change direction after ascending the ramp. Changing direction across the flared sides of the ramp would be much more difficult. The landing should be at least 1200mm but preferably 1500mm wide.

The maximum gradient should preferably be 8 per cent (1 in 12) on the direct approach and 9 per cent (1 in 11) on the flared sides. A ramp that is too steep is as inaccessible and more unsafe than its equivalent in stairs, as it cannot be used by wheelchairs, and is harder to negotiate by pedestrians. As with footways in general, slope changes between kerb ramp and pavement should be gradual to prevent the front wheels of a wheelchair getting caught.



**Figure 3.21** Kerb extensions reduce the crossing width for pedestrians

Kerb ramps should as far as possible be oriented perpendicular to the kerb. Skewed ramps can cause problems for wheelchair users and persons pushing trolleys or carts, as a skewed approach can lift one wheel off the ground, compromising balance and control. It follows that providing two ramps at road junctions is far preferable to only one, if space allows. The single ramp design has the additional drawback of aligning pedestrians in the wrong direction, and could lead visually impaired persons inadvertently into the middle of the junction.

Drainage should be considered at the bottom of kerb ramps.

### *Traffic signals*

Most countries have guidelines on when to install traffic signals at crossings, depending on the prevalent safety and traffic flow conditions. If a traffic signal is used, the red phase should keep traffic stopped for about 12 seconds for a 7.5 metre crossing to allow most disabled pedestrians to complete their crossing. Signals that can be activated by the pedestrian are useful, particularly at mid-block crossings, using a push button box. A large diameter (up to 50mm) raised button that can be activated by a closed fist will be usable by most people. Traffic signal poles and push buttons should also be colour contrasted.

At signalised intersections audible signals can be very useful to visually impaired pedestrians. Audible signals may encourage safer crossing behaviour among children. These signals have a bleep which sounds during the first part of the green phase to indicate when it is safe to cross the road. To help visually impaired pedestrians the push button box should be located consistently at crossings.

### *Tactile warning surfaces*

Tactile surfaces are important at the edge of street crossings to warn visually impaired pedestrians they are about to step on to the road. Various types of tactile surfaces are used across the world, as described in Section 5 above. What is most important is that, whatever tactile surfaces are used, they are used consistently and sparingly to avoid confusion within a country. In addition layouts should also be consistent.

Research conducted by TRL has indicated that flat topped domes are acceptable both to people with ambulant disabilities and to wheelchair users. (*Gallon et al., 1991*).

### *Traffic calming*

Various methods can be used to increase crossing safety by reducing the speed of vehicles. Traffic calming measures like speed bumps or pinch points can be very effective in developing countries due to their low cost nature. Raised crosswalks can be used both to slow down traffic and to provide a level crossing for pedestrians (see Figure 3.22). In Santiago, for example, raised crossings are used effectively at side streets and junctions to slow down right-turning cars (in right-turning traffic). Raised crossings should be designed with a minimum width of 2400mm (as other crossings), and built at the same level as the footway.

### *Guardrails*

Guardrails may help to improve pedestrian safety at road intersections in cities in developing countries where low road user discipline is the cause



**Figure 3.22** Raised crossings used judiciously can enhance pedestrian safety and accessibility

of many accidents. To be clearly detectable guardrails should be at least 1100mm high and painted to contrast clearly with the surroundings. Simple galvanised railings are not acceptable unless they have contrasting markings on them.

### **Where to start?**

Whenever new street crossings are constructed, or existing ones are upgraded, the opportunity should be taken to install at least kerb ramps, even if other features are only to be added at some future date. If possible, the opportunity should also be taken to move street signs, bins etc. that block the pedestrian flow on the footway. If an authority has to prioritise at which crossings to install the access features described here, the decision could be guided by factors like:

- Prioritising street crossings that are part of accessible networks (see Part 2), and are thus important for completing an origin-to-destination travel chain for disabled people.
- If no accessible networks have been identified in the city, then prioritising crossings with high pedestrian volumes (like in central business districts) or near major public transport stops.
- Or prioritising crossings where vulnerable pedestrians like children, disabled people, or patients would benefit from improved safety and accessibility. Examples include crossings near schools, hospitals/clinics, or sheltered homes/workshops for disabled people.

Minimum requirements for these crossings will be dictated by what is needed to ensure adequate levels of safety for pedestrians. Usually this will include at least clear markings, signage and/or traffic calming measures to warn motorists of the crossing and to slow down vehicles; in other cases high pedestrian volumes and high vehicle speeds may require traffic signals to be installed if affordable. It must be remembered that, without signal control, many visually impaired people will be unable to use crossings on busy roads without help.

### **Further references**

- Access Board (2002). Americans with Disabilities Act Accessibility Guidelines for Buildings and Facilities (ADAAG). (Retrieved: 2003, from [www.access-board.gov/adaag/html/adaag.htm](http://www.access-board.gov/adaag/html/adaag.htm))
- Department of the Environment, Transport and the Regions and the Scottish Office (1998). Guidance on the use of tactile paving surfaces. London: Mobility Unit, Department for the Environment, Transport and the Regions. (Retrieved: 2003, from [www.dft.gov.uk](http://www.dft.gov.uk))
- European Conference of Ministers of Transport (1999). Improving transport for people with mobility handicaps: a guide to good practice. Paris: OECD.
- Gallon C, Oxley P, Simms B (1991). Tactile footway surfaces for the blind. Contractor Report CR257. Crowthorne: TRL Limited.
- Oxley P (2002). Inclusive mobility – a guide to best practice on access to pedestrian and transport infrastructure. London: Department for Transport. (Retrieved: 2003, from [www.dft.gov.uk](http://www.dft.gov.uk))
- Ross A, Baguley C, Hills B, McDonald M and Silcock D (1991). Towards safer roads in developing countries – a guide for planners and engineers. Manuals & Guides. Crowthorne: TRL Limited.

## 7 Bus stops

---

*Improving access to buses can provide significant benefits to many people with disabilities. Bus services cover large areas at relatively low fares in most cities of the developing world. Together with improved vehicle design and operation (discussed in Sections 9 and 10), improvements in bus stop design are needed to maximise the benefits achieved for all users. This may require coordination and partnerships between bus operators and local authorities. The improvements described here are in the context of formal (fixed-route) bus systems, but many elements may also be applicable to services provided by operators of informal modes (see Sections 8 and 10).*

*It is important to realise that bus stops typically consist of several components: a connection to the footway, waiting area, boarding area and street crossings. Attention should be paid to each component in turn, to ensure the whole functions in an accessible way.*

### Basic principles

#### **Safety:**

- Waiting area separated from traffic.
- Adequate clear space without obstacles and hazards.
- Personal security enhanced through good lighting and open design.

#### **Reliability:**

- Marking and enforcement to prevent parked cars from obstructing bus bay.
- Accessible walkway between bus stop and surrounding footway/building entrance(s).

#### **Accessibility:**

- Shelter and seat, especially if area prone to rain or extreme heat/cold.

- Clear markings with information on bus routes served from the stop.
- Kerb or platform at right height to minimise height of first step into bus.
- Layout and kerb height for wheelchair access to buses (if wheelchair accessible buses are provided).

#### **Affordability:**

To the Provider:

- Start by providing at least paved area, kerb and signage at bus stops.
- Install seats and shelters where most needed.
- Fund upkeep of bus stops by selling advertising space on shelters.

## Good practices

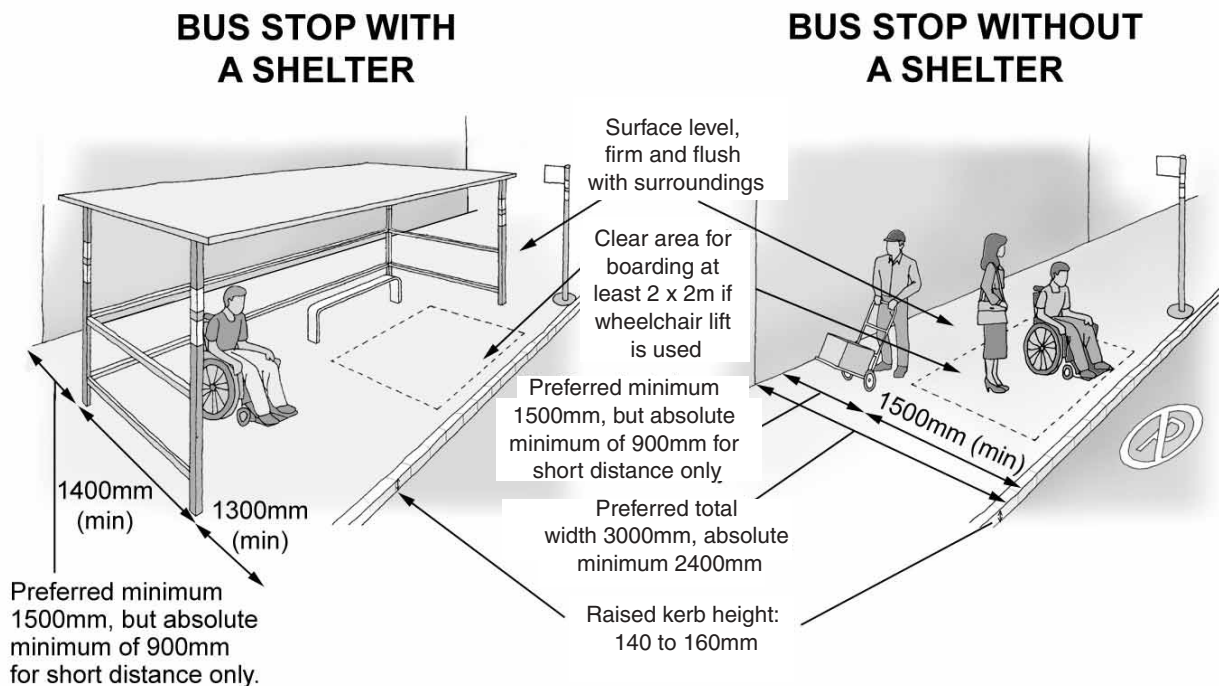

**Figure 3.23** Dimensions and layout of bus stops (adapted from Oxley, 2002)

### *Location and spacing of bus stops*

Section 3 indicated that many disabled people cannot walk long distances. While it is good practice anyway to place bus stops close to amenities, this becomes even more important when people with disabilities are being served. UK guidelines indicate that stops should ideally be provided so that nobody need walk more than 400 metres along a route.

### *Surface quality*

A paved and level surface around a bus stop can greatly help all passengers to safely board and exit the vehicle. Potholes, gaps between paving slabs, and drains should be removed or covered (see suggestions for surfacing, Section 5).

### *Bus stop layout*

Bus stops should have ample space for passengers to enter, wait and board, without obstructing other pedestrians passing by. Ideal clear dimensions for bus stops with and without shelters are shown in Figure 3.23. Where bus stops are provided in areas with more restricted space (which is often the case), the shelter can be sited against the rear of the footway. However, the clear footway width between the shelter and the

street should be 1300mm, with an absolute minimum of 900mm in severely restricted cases. These dimensions are adequate for accommodating wheelchair users while waiting for or boarding a bus. If boarding is achieved through the use of mechanical lifts (see Figure 3.40) or ramps, then extra space may be required for the lift to deploy and the wheelchair user to manoeuvre (typically 2m x 2m in total). But even if buses are not designed to board wheelchair users, the dimensions should be strived for to accommodate those who can transfer out of their chairs and other users who need the space.

The length of the bus stop should be sufficient to provide access to all entry and exit doors of the bus.

The use of bus bulbs (also called full width boarders) can be an effective way of providing more space while at the same time solving problems with buses failing to draw up close to the kerb. This situation often arises when vehicles parked in the parking lane obstruct bus stops, or when bus drivers fail to draw up across the parking lane to avoid having to weave back into traffic. Bus bulbs extend the footway across the parking lane to the edge of a traffic lane (see Figure 3.24). Research has shown that the use of bus bulbs actually *decreases* the delay caused by stopping buses, to both buses and other vehicles in the street (Fitzpatrick *et al.*, 2001). This is due to the fact that buses using a parking lane often also block the traffic lane, and in addition often block *two* traffic lanes when weaving back into traffic. Bus bulbs thus actually smooth the flow of traffic.



**Figure 3.24** A bus bulb or boarder in operation

### *Shelters and benches*

Shelters at bus stops can significantly increase the ease of using bus transport, especially in areas with extreme weather conditions. Very often the costs of providing and maintaining shelters can be fully recovered through the selling of advertising on the shelters. Advertising should be restricted to defined areas so it does not impinge on service information.

An accessible shelter provides ample space for users of wheelchairs and other aids to enter and manoeuvre; has a paved floor level with the surrounding area; and has a bench or seat for waiting passengers (Figure 3.23). The seat can be as simple as a rail to rest against or a wooden bench, but can be invaluable to infirm passengers unable to stand for long periods of time.

Seating should be fixed at a height of about 480mm and painted in a contrasting colour. Shelter supports should be marked with contrasting colour bands about 1500mm from the ground, to maximise their visibility to partially sighted people and at night.

Security, especially at night, is a major concern for many travellers with disabilities. Security in and around a bus shelter can be enhanced by providing good lighting (such as street lights) and removing unnecessary structures or panels that can serve as hiding places. Simple shelters are often the best.

### *Bus stop poles and information*

Bus stop poles indicate the spot where the entrance of an arriving bus will be. Stop poles will benefit visually impaired users and expedite boarding by all passengers. Poles should be painted with coloured bands to enhance visibility. If existing poles are used (such as lamp poles), very clear markings to distinguish them as bus stop locations are important for low vision passengers, as well as users unfamiliar with the system.

'Flags' (decals) could be used for this purpose, the lower edge about 2500mm from the ground (to provide adequate clearance), with at least the following information on them (see Figure 3.25 for details):

- Pictograph of a bus to identify it as a bus stop.
- Route number / name.
- Wheelchair symbol if services using the stop are fully (wheelchair) accessible.
- Telephone number for more information.

A limited amount of information tends to be better than a large amount as it avoids confusion.

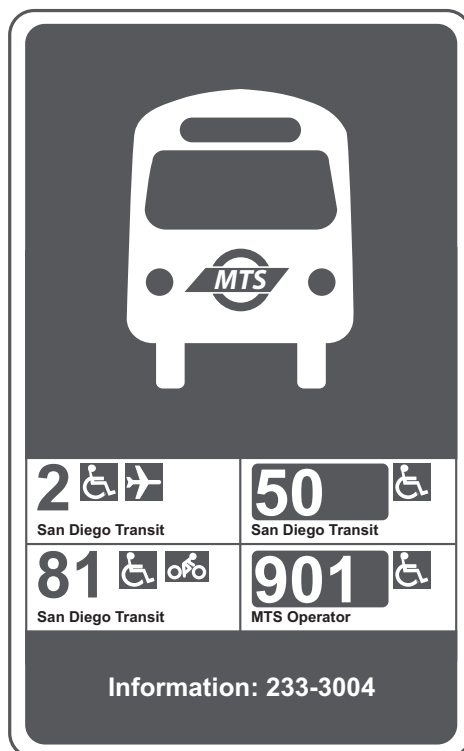

**Figure 3.25** Typical bus stop sign, USA (*Source: Dobies, 1996*)

Where timetable information is available, this should be provided in large print inside the bus shelter (see Section 14). Providing information on routes, destinations and departure times reduces uncertainty – benefiting all users in addition to those with disabilities (recalling the importance of reliability as an access principle). It specifically assists deaf or hearing impaired people, many of whom find verbal communication with the driver the largest barrier to public transport use.

This will only work, however, if the bus service generally keeps to the posted timetable; if not, it is probably better to omit detailed timetable information from the bus stop area but to make sure that passengers have access to further information via the operator's telephone number. Ideally there should also be a number for text phone to assist hearing impaired passengers.

Another factor sometimes limiting the display of information on the shelter is recurring vandalism. In such cases access to information by telephone can be a partial alternative.

To assist visually impaired passengers, it is often a good idea to provide important information in a tactile form. This can be in the form of numbers (about 20mm high) indicating the route number, attached directly to the pole. Letters, numbers or symbols that are slightly raised (1 or 2 mm) may be more appropriate than Braille in developing countries where relatively few blind people use Braille.

Section 14 describes guidelines for legibility of information, including letter sizes and tactile formats.

### *Boarding area*

It is practice in some countries to mark on the ground the exact spot where boarding takes place, to guide visually impaired people towards the bus entrance. This is done with a row of coloured tiles, about 2m long, and perpendicular to the kerb.

By raising the height of the boarding area, the height to the first step of the bus may be reduced sufficiently to make it much more usable by people with walking difficulties, children, or people carrying loads. The entire boarding area could be constructed at a height of 140 to 160mm above the street level. Care has to be taken to provide kerb ramps at the edges of the raised area (maximum slope 1:12) to provide access to wheelchair users.

### *Enforcement of no-parking zones*

To reduce the height of the first step into a bus, drivers need to pull up close to the kerb which requires driver training and enforcement of no-parking zones at the stop kerbs. It is therefore important to partner with traffic authorities to paint clearly marked no-parking zones at bus stops, and to enforce the zone.

### *Wheelchair access through raised boarding structures*

The use of low-floor bus designs and buses with mechanical lifts to create entry for wheelchair users into buses is likely to be limited in most developing countries due to cost factors and the need for high chassied vehicles to operate on poor roads. An alternative is to use roadside structures raising the passenger to the approximate height of the bus floor, in conjunction with bridging plates and appropriately designed bus interiors. Such approaches have been used very successfully in bus rapid transit systems in Latin America (see Box 3.4), where buses operate on their own exclusive rights-of-way and specially designed bus stops. Some experimentation has been undertaken with roadside access structures in mixed traffic (see Box 3.5), indicating that such solutions may be affordable and appropriate to the rugged conditions of developing countries. However, more widespread application of such concepts is needed (in mixed traffic) before best practice can emerge.

### Box 3.3 Low-cost improvements to bus stops

A recent demonstration project in Pune, India, showed that all passengers value the improvements made to bus stops as part of upgrading their accessibility. The following low-cost improvements were made to all bus shelters along one bus route:

- widening entrances into the shelter to at least 1 metre;
- providing benches to be usable by all passengers;
- providing large print route information signs in the shelter; and
- removing barriers in or near the shelter which hinder movement or could injure users.

Passenger surveys demonstrated a higher usage of the bus shelters and higher levels of comfort *after* the changes were made. A total of 69% of passengers found the bus shelters 'comfortable' or 'very comfortable' after the project compared to just 19% prior to the bus stand enhancement. The surveys highlighted the importance of driver training to ensure that passengers using bus shelters are given sufficient time to board the bus and increase passenger confidence in their usefulness.

In terms of information adequacy and clarity 50% found the information provided at bus stands after the demonstration project had been implemented to be 'very clear' compared to just 4% before the project. The information boards were found particularly helpful to hearing impaired passengers who valued the independence it provided them.



*Figure 3.26 Large print route information at bus stop, Pune*



*Figure 3.27 Upgraded bus stop showing colour contrast and seating in Pune*

### Box 3.4 Bus rapid transit: access for all in urban transport

Universal design features are included in Latin American versions of 'Bus Rapid Transit' (BRT). First begun in Curitiba, Brazil, BRT concepts have since been replicated in Quito, Ecuador's, trolley system, and in Bogotá, Colombia's, bus system, and are being planned or investigated in many other cities across the world. BRT systems use high-capacity buses in densely populated urban areas, typically on express routes using exclusive rights-of-way.

The concept, as used in Latin America, includes a number of elements that foster access for all:

- BRT systems use enclosed raised platforms at each stop. Passengers do not pay the bus driver, but rather pay their fares when entering the enclosed platform. This makes it easier to regulate the system and to pay bus drivers by the hour worked, not per passenger. This can promote safe operation by eliminating competition among drivers to pick up more passengers.
- Platforms are usually made accessible by ramps or lifts for all passengers. Passengers enter and depart buses at floor level, using bridges lowered from the bus to the raised platform. This provides level access between the vehicle and the platform.



*Figure 3.28 Raised bus tubes from which passengers board at floor level into buses (such as in Curitiba, Brazil) (Photo by Charles Wright)*

As with any bus system, BRT systems are not truly accessible unless pedestrian routes to the bus stops are also accessible.

For more information from Brazil concerning Curitiba's BRT system, go to [www.curitiba.pr.gov.br/pmc/ingles/Solucoes/Transporte/index.html](http://www.curitiba.pr.gov.br/pmc/ingles/Solucoes/Transporte/index.html).

In addition, a similar system with excellent features was inaugurated in late 2000 in Bogotá. See [www.transmilenio.gov.co](http://www.transmilenio.gov.co)

### Box 3.5 Use of raised boarding structures

In the long run bus fleets need to be replaced with better designed buses that are more accessible and user-friendly to all passengers. However this will take time. Meanwhile, innovative solutions coupled with better driving training may benefit many users. One such solution involves the use of raised structures built at selected bus stops.

Although not a universal design solution serving all passengers, these structures may be a low-cost solution serving people who have difficulty boarding buses with high steps, especially at stops used by many vehicles.

In recent experiments with bus systems in Mozambique, small kerbside platforms were erected at major bus stops. At about 30cm high, the platforms more than halved the height to the first step of the bus. In Mozambique, about 20% of elderly and ambulatory disabled people chose to board the bus from the platform. However, the experiment also showed the importance of more orderly operation to make this kind of approach workable. Bus drivers were soon prevented from consistently stopping close to the platforms, by the interference of informal taxis using the same stop in a very disorganised manner. Thus the benefit of the platforms was severely eroded.



Figure 3.29 Easier boarding in Pune, India



Figure 3.30 Minibuses blocking boarding platforms, Maputo, Mozambique

*Continued ....*

### Where to start?

Bus stops that currently have no facilities should at a minimum be levelled and paved, and provided with a kerb delineating the passenger space from the space used by buses. This sets the stage for more orderly operations and improved safety. If combined with driver training, it can be used directly to reduce the effort of boarding and alighting by reducing the first step height. At a minimum a colour contrasted pole should be provided clearly identifying it as a bus stop. Secondary features that should be considered are provision of more information on the pole, a shelter, and seating.

### **Box 3.5 (Continued) Use of raised boarding structures**

Wheelchair access provided to high-floor buses in a three-month demonstration project in Pretoria (South Africa) showed the use of wayside platforms equipped with bridge pieces to be a feasible way of providing access to users who can not negotiate bus steps. Drivers were trained to position the bus correctly, assisted by paint markings on the road, and they consistently mastered the task well.



*Figure 3.31 Illustrations of bus wayside platforms, Pretoria, South Africa*

Bus stops that currently have shelters should, likewise, firstly be examined for surface quality, kerb, and a clearly marked identifying pole. This would ensure that ambulant passengers can at least identify and enter the bus stop area. It is then important to remove obstacles such as street furniture so that passengers with disabilities can use at least some part of the shelter, and preferably all of it. Since there already is a shelter, seating can be added at relatively low cost. A further consideration would be the provision of information on the pole using a flag and tactile lettering.

New bus stops should at least be paved, kerbed and provided with a pole. Even if a shelter is not immediately erected, it should be laid out with adequate space for an accessible shelter to be installed in the future. New stops should also provide more space than the minimum indicated in this guide.

Where bus stops have to be prioritised for treatment, a good starting point would be with stops most frequently used by people with disabilities, such as in front of medical facilities, workshops, etc. As part of accessible networks (see Part 2), these stops should be connected by accessible footways, street crossings, and kerb ramps to the origins and destinations of disabled bus users.

## Further references

- Access Board (2002). Americans with Disabilities Act Accessibility Guidelines for Buildings and Facilities (ADAAG). (Retrieved: 2003, from [www.access-board.gov/adaag/html/adaag.htm](http://www.access-board.gov/adaag/html/adaag.htm))
- Balcombe R and Vance C (1998). Information for bus passengers: a study of needs and priorities. TRL Report TRL330. Crowthorne: TRL Limited.
- Dobies J J (1996). Customer information at bus stops. TCRP Synthesis Report 17. Washington DC: National Academy Press. (Retrieved: 2003, from <http://www.trb.org/>)
- European Conference of Ministers of Transport (1999). Improving transport for people with mobility handicaps: a guide to good practice. Paris: OECD.
- Fitzpatrick K, Hall K M, Farnsworth S, Finley M D (2001). Evaluation of bus bulbs. TCRP Report 65, Washington DC: National Academy Press. (Retrieved: 2003, from <http://www.trb.org/>)
- Institute of Highways and Transportation (IHT) (1999). Planning for public transport in developments. London: IHT. (Retrieved: 2003, from [www.iht.org](http://www.iht.org))
- Oxley P (2002). Inclusive mobility – a guide to best practice on access to pedestrian and transport.
- Rickert T (1998). Mobility for All: Accessible Transportation Around the World. Access Exchange International: San Francisco. (Retrieved: 2003, from [www.independentliving.org](http://www.independentliving.org))
- Infrastructure. London: Department for Transport. (Retrieved: 2003, from [www.dft.gov.uk](http://www.dft.gov.uk))
- Tyler N A (ed) (2002). Accessibility and the bus system: from concepts to practice. London: Thomas Telford.
- UNESCAP (United Nations Economic and Social Commission for Asia and the Pacific) (1995). Promotion of non-handicapping physical environments for disabled persons: guidelines. New York: United Nations

## 8 Facilities for informal modes of transport

---

*Services are frequently provided by public transport operators of informal modes, including minibuses, shared taxis and motorised rickshaws. A defining characteristic of these services is that they are typically provided by a large number of individual owners, on relatively flexible routes and schedules, and that authorities typically have very little regulatory control over them. This also means that informal services have historically operated with very few formal passenger facilities as operators allow passengers to board and alight anywhere in the system network. In those locations where facilities are used they have often been taken over from formal bus operators and are usually poorly maintained.*

*Given the important role that informal operators play in providing public transport services in developing countries, some governments are starting to be more active in providing and maintaining passenger infrastructure. Wherever this occurs, some basic principles should be followed to ensure that facilities serve the broadest spectrum of users possible, including people with disabilities. This section deals with stops (on-route facilities) and ranks (end-of-route or transfer facilities) for informal operators. By their nature they tend to be less formal facilities than those associated with formal bus services. As informal services become more formalised, better organised, and institutionalised, facilities may become more formal and in these cases many of the good practices described in Section 7 will become applicable.*

## Basic principles

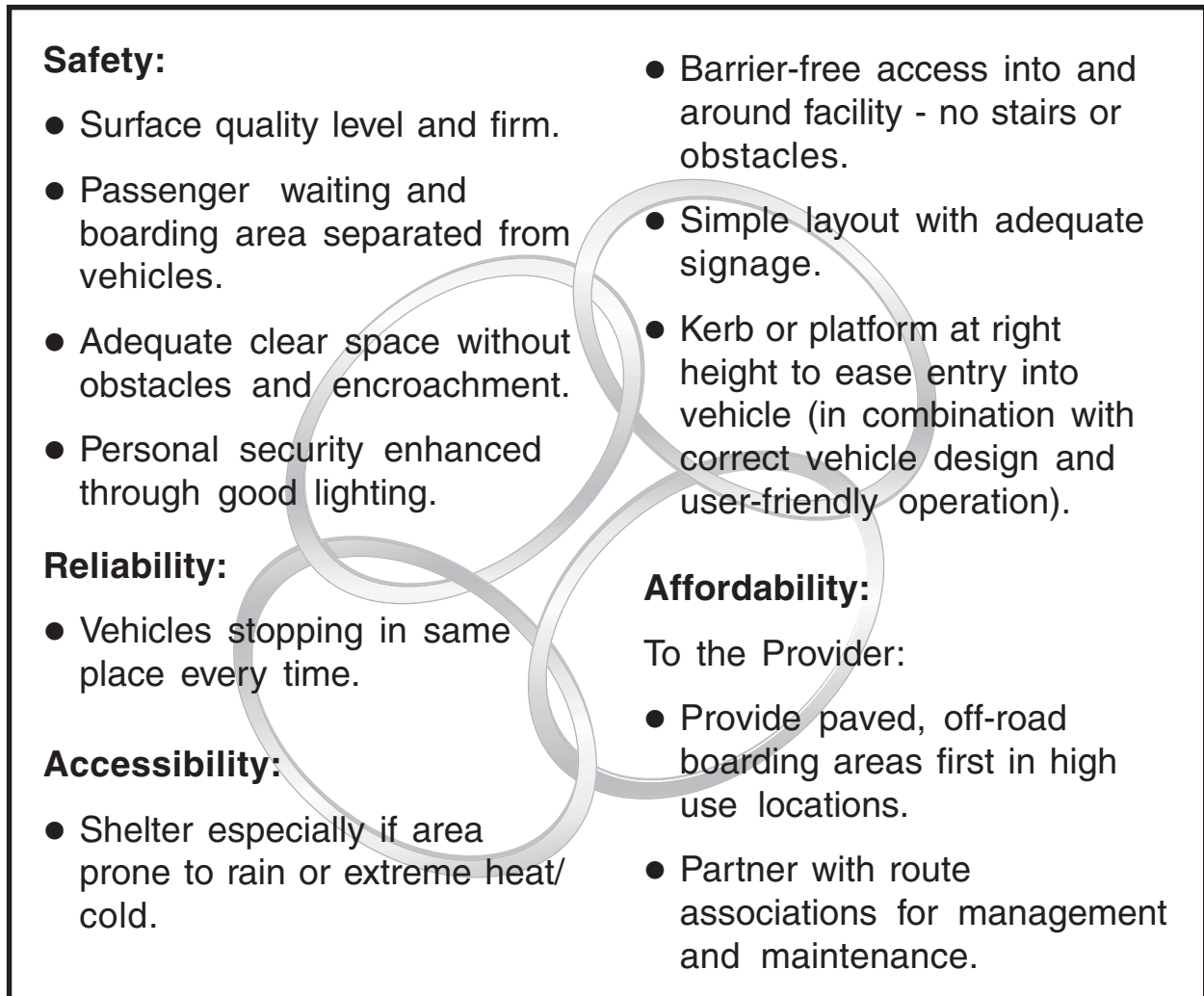

## Good practice

### *Layout*

The user-friendliness and safety of informal transport can usually be improved for all passengers by creating more orderly operations. The correct design of facilities can significantly enhance this. Along the route, designated on-street stopping places (or lay-bys) would help prevent disorderly stopping and guide would-be passengers towards safe places to board a vehicle. Both at major on-street lay-bys serving numerous destinations and at off-street ranks and transfer points, destinations should be grouped together and served from the same point (clear signage to this effect will benefit both drivers and passengers, see Figure 3.32).

The layout of lay-bys and ranks should furthermore clearly separate the space used by vehicles from the space used by passengers. This will enhance safety for all passengers, and specifically allow slow-moving, visually impaired, and other vulnerable passengers to navigate through the facility more easily. A good way of achieving this is to raise pedestrian space above the road level using standard kerbs and paving.



**Figure 3.32** Destination rank signage in a minibus taxi rank

The layout should minimise the number of places where pedestrians have to cross the path of vehicles. Kerb ramps should be installed to allow pedestrians using wheelchairs or walking aids, to leave the kerb in safe places. Kerb ramps should have a maximum gradient of 8% and be fitted with tactile warning strips to warn visually impaired people they are leaving the pedestrian space (see Sections 5 and 6). Raised crossings can also be used to overcome level changes while slowing down traffic at the same time.

If drivers tend to ignore the kerbs and park on them, bollards can be installed as a deterrent. Bollards should be at least 1000mm high and colour contrasted to enhance visibility. Bollards should be placed outside the clear way used by pedestrians.

#### *Pedestrian clearways*

Clear space for pedestrians, including those with walking aids and visual impairments, should be a minimum 1800mm wide for areas of heavy pedestrian flows, and 900mm in other places to allow a wheelchair to pass. It is important to keep this clear space free of obstacles such as signage poles, chairs, vehicle parts and vendors. Achieving this goal requires some supervision and enforcement, which is often not available at informal facilities. But careful design of a facility can contribute towards keeping pedestrian space clear, including:

- Clear marking of the pedestrian space by paving or painting it a different colour.

- Providing designated spaces for vendors that are just outside the clearway but not so far removed from pedestrian flows as to be unattractive to vendors (see Figure 3.33).



**Figure 3.33** Clear pedestrian space created with paint

Although the smaller buses used by informal operators usually have relatively low floor heights, this is not always the case and passengers may be helped to board if they can step immediately from the kerb into the vehicle. This can only be achieved, however, if drivers pull up close enough to the kerb. Authorities may have to provide enforcement and training along with positive incentives to encourage this type of good practice.

#### *Surface quality*

A level and smooth surface is essential wherever passengers move, to ensure that people with walking difficulties and visual impairments can safely move about the lay-by or rank. Paved surfaces are best, especially in areas with heavy rainfall. The surface should be slip resistant.

#### *Seats and shelters*

Operators of informal modes typically provide fairly high service frequencies, so that passengers often do not have to wait long before boarding a vehicle. Nevertheless during the off-peak or when travelling to less popular destinations passengers may need to wait for longer periods of time. Major ranks should have some seating available for people who cannot stand for long periods of time. Seats can be as simple as wooden benches or perch-type rails to lean against. Seats should be 480mm high and painted to contrast with the surroundings. Shelters providing

protection from sun and rain can be very helpful at passenger waiting areas but also where passengers board. Section 7 describes simple shelters for bus stops which are also suited to informal operations, where space allows. Shelters may sometimes be shared between formal and informal transport services, although this is rarely the case.

### *Passenger amenities*

If passenger amenities such as toilets, telephones, and kiosks are provided at ranks or transfer facilities, attention should be paid to accessibility. Of those provided, it is recommended that at least one (unisex) toilet and one telephone be accessible to people with disabilities, following the layout and dimensions described in Section 12. Any steps, stairs or ramps should also follow the guidelines given in Section 12.

### *Signage and information*

Designated lay-bys and ranks for informal transport services should be identified as such, to guide the visitor, the visually impaired people and the occasional user to the correct boarding place. Whether signage is attached to a pole, a shelter or other structure, it should be clear and simple (see Figure 3.25). If stopping places are separated by destination, the names of the destinations served should also be indicated (see Section 14 for best practice). Some authorities employ full-time rank managers to manage operations – these employees can be useful for providing information, provided they have undergone disability awareness training, are easily identifiable and courteous.

## **Where to start?**

The first step towards improving the user friendliness of informal transport services is often to increase order and formalisation among the operators. Potential partners in this process are operators' associations representing groups of drivers and/or owners (see Box 3.6 for more). Once investment in better facilities is possible, a good start may be to upgrade facilities at major destination and transfer points such as in business districts. This will benefit the most people for the given amount of funding. To enhance access, the most important priority seems to be to create enough orderliness in the way vehicles are driven and parked that pedestrians and vehicles can be safely separated. If this is done through the provision of kerbs and paving, the opportunity can also be used to ensure that pedestrians have a paved and level surface to walk on, and that enough space is provided for unobstructed pedestrian movement. These measures will specifically benefit passengers who walk with difficulty, are visually impaired, and those using walking aids or wheelchairs.

### Box 3.6 Improving accessibility through concessioning

One way for governments to improve the quality and accessibility of transport services that are provided by private operators, is through concession agreements. Concession agreements are contracts - typically for 3 to 5 years – spelling out the rights and responsibilities of transport providers ('concessionaires') and the rights and responsibilities of the government agency granting the concession. Such agreements are in widespread use in Latin America, for instance, as a means of regulating the many small-scale operators providing mini or midibus transport.

Ways in which the concessioning process can promote basic accessibility include:



*Figure 3.34 Concession agreements can require low-cost features such as contrasting steps and handrails on midibuses*

- 1 Require low-cost access features at the time of concessioning:** The contract can specify minimum vehicle standards such as non-skid flooring, painting hand grips and steps a bright contrasting colour, the use of large print destination signs on the vehicle, and the use of priority seating for older and disabled passengers. These features cost very little and assist all passengers, not only those with disabilities.
- 2 Require basic training in safe accessible operation:** Such training could focus on safe driving practices, including coming to a complete stop to permit disabled passengers to board and remaining stopped until they are seated. Training can also emphasise the value of periodic preventive maintenance to keep vehicles in good operating condition. Training can be reinforced by posters and other means to remind drivers of their duty to operate safely. Depending on the local situation, drivers could be required to pass safe driving tests before being permitted to drive.

*Continued ....*

### **Box 3.6 (Continued) Improving accessibility through concessioning**

**3 Require vehicle inspection:** Even if nothing else is done, a concessioning agency must at least require a simple inspection of vehicle safety features before permitting a concession to begin, followed up by safety inspections on at least a yearly basis. Initially, an inspection might be limited to a visual inspection to ensure that:

- headlights and brakes work;
- tyres are safe;
- the different access features noted above are present and well maintained.

Upon passing the inspection vehicles could receive an inspection sticker, which would also help with enforcement.

**4 Mandate methods to empower passengers:** Passengers need to be acknowledged as stakeholders in the provision of accessible transport. It is appropriate to spell out in the concession agreement the methods that will be used for achieving passenger input into improving services.

The concessioning agency could provide a mechanism for passengers to evaluate services. Examples could include a complaint number connected to the regulating agency, or surveys of user satisfaction. Special emphasis could be placed on evaluations by members of local NGOs representing disabled persons.

The regulatory agency could appoint an ombudsman or other individual to receive complaints and act on behalf of passengers.

Exemplary driver behaviour could be rewarded and publicly recognised (e.g., with cash prizes, letters of commendation, plaques, radio or newspaper publicity).

Passengers could be invited to an annual meeting to discuss the service and register their views.

*Continued ....*

### **Box 3.6 (Continued) Improving accessibility through concessioning**

**5 Provide incentives for accessible operation:** If a government agency charges even a modest franchise or concession fee for the right to operate on a route, this fee could then be reduced or waived as a reward to those who provide accessible services.

These approaches are especially helpful when there are multiple providers or associations competing with each other for a concession. However, competing concessionaires on the same route may easily lead to unsafe and inaccessible driving behaviour. The ability to reward good performance and to punish bad performance is a major factor in assuring transport for all.

**6 Consider the pros and cons of fare subsidies when preparing to solicit bids for concessioned routes:** This is a controversial matter, since a requirement that disabled passengers pay a lower fare can become an incentive for drivers not to serve such passengers if their income comes directly from the fares received. Subsidies may work best when service is carefully monitored to assure that disabled passengers are not denied service.

**7 Consider working closely with operator associations in developing requirements for a concession:** Association input could be helpful, depending on the politics of the local situation. Ideally, the interests of an association would include a desire to avoid highly competitive practices among its members such as speeding to pick up waiting passengers, or passing up disabled passengers. In other words, in some situations an association can become an instrument to introduce more self-discipline among its members. In such cases, the regulator should have the power to penalise the association itself (not just the individual driver) for unsafe practices, in order to encourage the association to enforce discipline among its members.

#### **Further references:**

See [www.worldbank.org/transport/pol\\_econ/contract.htm](http://www.worldbank.org/transport/pol_econ/contract.htm) for a discussion by Kenneth M. Gwilliam of the World Bank of concessioning transport services in developing countries. Eduardo Vasconcellos provides a helpful overview of the larger context of privatisation and regulation in Urban Transport and Structural Tensions in Developing Countries at [www.people.cornell.edu/pages/sb24/](http://www.people.cornell.edu/pages/sb24/).

Along the routes operated by informal operators, major stopping places should be treated first by constructing lay-byes, together with raised kerbs and paved footways to assist passengers (see Figure 3.35).



**Figure 3.35** Safety and accessibility can be enhanced as a first step simply by providing a paved off-road boarding area for bus and taxi passengers

### Further references

- Access Board (2002). Americans with Disabilities Act Accessibility Guidelines for Buildings and Facilities (ADAAG). (Retrieved: 2003, from [www.access-board.gov/adaag/html/adaag.htm](http://www.access-board.gov/adaag/html/adaag.htm))
- British Standards Institute (2001). Design of buildings and their approaches to meet the needs of disabled people – code of practice. BS 8300:2001. London: British Standards Institute.
- European Conference of Ministers of Transport (1999). Improving transport for people with mobility handicaps: a guide to good practice. Paris: OECD.
- Oxley P (2002). Inclusive mobility – a guide to best practice on access to pedestrian and transport infrastructure. London: Department for Transport. (Retrieved: 2003, from [www.dft.gov.uk](http://www.dft.gov.uk))
- Rontiris K (1990). Guidelines for the design of combi taxi facilities. Pretoria: Department of Transport.

- Sohail M, Mitlin D and Maunder D A C (2003). Partnerships to improve access and quality of public transport. Guidelines. Loughborough: WEDC, Loughborough University.
- UNESCAP (United Nations Economic and Social Commission for Asia and the Pacific) (1995). Promotion of non-handicapping physical environments for disabled persons: guidelines. Annex 2. New York: United Nations.

## 9 Design and operation of buses

---

*Despite the decline of formal public transport operations in developing countries in recent decades, large capacity buses continue to transport significant numbers of passengers in cities on all continents. In Europe significant gains have been made in the accessibility of buses through the development of low-floor vehicles, which provide step-free boarding to wheelchair users and all other passengers. Lower-floor vehicles are gradually being introduced in cities in South America and Asia. Yet, in most developing countries, buses with high floors (typically 1m above ground level) remain popular due to their affordability and their suitability to rugged operating conditions. Their entrances (narrow, steep, and with high steps) and internal layout (narrow seat spacing) typically make them difficult to use for many passengers, especially for those with less agility. Significant improvements can, however, be made even before addressing the problem of high floor heights, which is ultimately needed.*

*Another universal design solution is the use of specially designed high-floor buses with boarding platforms. These increasingly popular 'Bus Rapid Transit' systems largely serve concentrated high-volume corridors in cities, but still require conventional boarding solutions along feeder routes off the main corridors. It is therefore likely that the use of conventional buses will continue to predominate in developing countries for at least the foreseeable future.*

*This section considers incremental improvements to conventional buses to help people with disabilities to board, travel in, and alight from such vehicles more easily, quickly and safely. Improvements are needed in both the design and operation of bus services. Solutions like clear signage, adequate handrails and prioritised seating can be implemented at low cost and help to retain existing users as well as to attract new ones and boost revenue. To capture the maximum benefits, usability improvements to vehicles should be coordinated with improvements to infrastructure. This section should be read in conjunction with Sections 5 to 8.*

## Basic principles

### Safety:

- Wheelchair users should be able to travel safely.
- Dedicated wheelchair space for wheelchair users to remain seated in their wheelchair.
- Smooth driving and braking to avoid injury.
- Way to request a stop without passenger leaving their seat.
- Handrails and stanchions for boarding, alighting and standing passengers.

### Reliability

- All advertised accessibility features available and working.
- Bus stops in same place every time.
- Clear announcement of major stops.
- Bus driver and conductor providing helpful service and assistance.

### Accessibility:

- Easy and unhindered boarding via steps (if any).
- Level boarding for wheelchair users into bus.
- Step noses and hazards highly visible.
- Priority seats near entrance available for disabled passengers.
- Easy stowage of mobility aids (wheelchairs, walking sticks).
- Clear signage indicating bus route/destination, fare, and other relevant information.
- Bell/light activation to inform driver of request to stop.

### Affordability

#### To the Provider:

- Retrofit existing buses with low-cost features for ambulatory passengers.
- Introduce wheelchair access route by route.

#### To the User:

- Concessionary fares could be considered.

## Good practices

### *Bus entrance*

The height and steepness of steps in high-floor buses are often major barriers to users with disabilities. Entrances can be improved through adequate design of steps and installation of handrails and grab handles.

Since specifications for steps vary somewhat across different countries, and local circumstances dictate what can be achieved, a useful starting point is to state what is considered 'ideal' from the point of view of enabling the largest number of ambulant disabled people to enter and exit buses easily and safely. Working back from there, one can then determine what is adequate to aim for in the short to medium term. The UK's *Disabled Persons Transport Advisory Committee (DPTAC)* has advised on 'ideal' specifications, but acknowledge that many operators cannot meet these standards with existing fleets, so included less-than-ideal specifications that may be used during a transition period (*DPTAC, 1996*). Table 3.5 summarises both the ideal and the transitional specifications for vehicles which are not designed with a low floor. In the UK, Public Service Vehicle (PSV) accessibility regulations (2000) require all buses carrying more than 22 passengers to be low floor. Bus operators, regulators and other stakeholders in developing countries must apply their own judgment to select from this range.

A low-cost way to lower the distance to the first step without interfering with the need for high clearance of the bus chassis, is to use a foldable step attached to the stairwell (see Figure 3.36). The step is deployed automatically when the door opens, or manually by the driver via a lever by his seat.

### *Handrails and stanchions*

As fear of falling is a major deterrent for bus use among elderly and disabled people, provision of adequate handrails can be of major assistance. Handrails at the entrance are very important. Handrails are even more necessary when step heights and depths depart from the 'ideal' dimensions of Table 3.5. In fact, handrails can to some extent off-set the negative effects of inadequate step design. Entrance handrails should extend as far out towards the entering passenger as possible, starting from a point within 100mm from the outside edge of the first step. Handrails are needed on both sides of the entrance as some people can only use one side of their bodies. Handrails on both sides also help passengers carrying packages or children. In some cases, folding doors may need to be strengthened at the time of manufacture to support handrails.

**Table 3.5 Ideal and transitional specification for bus entrances (no wheelchair access)**

<i>Item</i>	<i>Ideal specification</i>	<i>Transitional specification</i>
Maximum first step height	250mm	325mm
Maximum height for subsequent steps	200mm	225mm
Maximum number of steps (total)	3	3
Maximum ground to floor height	650mm	775mm
Minimum depth of steps	300mm (280mm on vehicles less than 2.5m wide).	
Step risers	Vertical, smooth, flat, colour contrast on nose.	
Minimum ceiling height at door	1.8m above first step.	
Entrance width between handrails	min 700mm, max 850mm (single stream) min 530mm, max 850mm (for wider doorways with central handrail). Handrails to start within 100mm from outside edge of first step.	

*(Source: DPTAC, 1996)*

*The transitional specifications have been superseded in the UK by the Public Service Vehicle Accessibility Regulations 2000*



**Figure 3.36** This accessible bus in Mexico City features a lift and a retractable front step *(Source: AEI)*

Sloping handrails (parallel to the slope of the steps) are better than vertical ones. Handrails can be fixed to the inside of the door as long as they do not move excessively when the door is open. If possible handrails should be provided in a continuous path from the entrance at a height of 800-900mm, past the driver, to at least one of the priority seats, to help visually impaired and other disabled passengers reach their seats.

Handrails should be round, 30mm to 35mm in diameter, and fixed with a minimum clearance of 45mm to the adjacent surface to allow for good grip. Good grip is also promoted by using a non-slip rather than a polished finish.

Inside the bus, vertical handrails or stanchions at every second row of seats are very helpful to passengers moving around. If there are many standing passengers, stanchions could even be provided at virtually every row (Figure 3.37). The maximum recommended distance between handrails is 1050mm so people can reach one stanchion from another. Inward facing seats should have one vertical stanchion to every two seats. Hanging straps and ceiling mounted rails are not usable for many passengers.

For good visibility handrails and stanchions should be painted in a colour contrasting with the surroundings, such as bright yellow, orange, or bright green. The same colour should also be applied to the edges of any steps, the outlines of information sources such as fare boxes, and bell pushes.

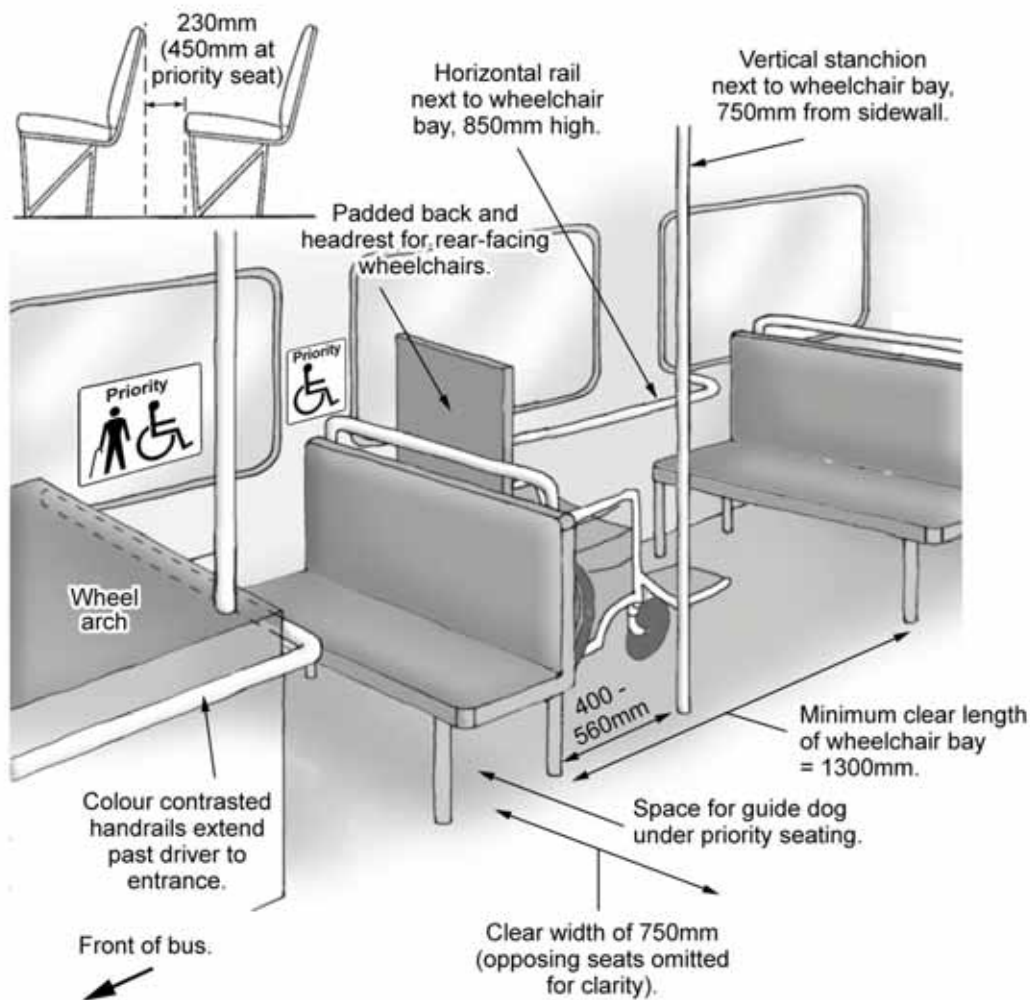

**Figure 3.37** Handholds/grips, stanchions and colour contrasted interior, India

### Seats and floor

The floor of the bus should preferably be flat and level from the entrance at least to the middle of the bus to make it accessible for wheelchair users. Many passengers feel insecure on sloping surfaces, and would also want to avoid internal steps in the bus. If no alternative exists, steps of 150mm to 200mm high or slopes of up to 1:30 (over short distances) are recommended.

To allow the highest number of passengers to travel whilst seated, seats should be at least 450mm wide (per passenger), between 430mm and 460mm high above the floor, and allow at least 230mm leg room (Figure 3.38). Well-spaced seats will help speed up boarding and alighting as passengers can move to and from their seats more easily. If these dimensions cannot be provided throughout the bus, they should at least



**Figure 3.38** Recommended layout and interior dimensions for buses (Source: DPTAC (1996) / DETR (2000a))

*(Note: COST 322 recommends slightly larger dimensions for European countries. Check for local wheelchair dimensions)*

apply to the first few rows of seats. Handholds on the top of seats are also very useful to help passengers to get up from the seat.

It is good practice to reserve two or more seats for elderly and disabled passengers, as many find it impossible or dangerous to stand in a moving vehicle.

**Priority seats** are therefore especially important in overcrowded buses. These seats should be as close as possible to both the driver and to the entrance/exit, to facilitate communication with the driver and to minimise the distance walked in the bus. It is thus good practice in two-entrance buses to allow disabled passengers to board and alight through the front door, even if all other passengers must board through a rear door. Clear signage (see Figures 3.38 and 3.39) should identify priority seats. Seats installed on top of the wheel arches are usually raised further from the floor and subject to higher acceleration forces (discomfort) and therefore not suitable for most disabled people. Priority seats should be either forwards or rearwards facing, with legroom extended to 460mm, and adequate space should be available under them for a guide dog to lie down if needed.



**Figure 3.39** Priority seating behind the driver, used in midibuses in Mexico City

The passage should be wide enough for all passengers to move freely: a minimum unobstructed width of 450mm is recommended. Directly behind the driver (at least up to the priority seating and wheelchair bay, if there is one) this could be increased to 800mm to assist with passenger circulation.

### *Boarding for wheelchair users*

The best way to allow wheelchair users to board buses is through universal design: the use of low-floor buses with extendable ramps, or high-floor buses with raised boarding platforms (such as those used in many bus rapid transit systems). These options also benefit the operator by speeding up boarding and alighting. Achieving universal access requires a systems approach that pays attention to multiple vehicle, infrastructure and operations related aspects. The references at the end of this section can be consulted for more information.

Other options for overcoming the height difference between the ground and the bus floor include the use of mechanical lifts (deployed either in the main doorway or from a separate doorway), and level boarding from small roadside platforms, using a removable bridge piece to cover the gap. Both of these options are only deployed when needed by a disabled person. See Box 3.5 for example from demonstration project in South Africa. Wheelchair lifts are more expensive options, both to acquire and to maintain, and thus may be less affordable for widespread use in bus fleets. Nevertheless lift-equipped high-floor vehicles, especially if these vehicles are used on routes that are specially designed to serve persons with disabilities (see service routes, Section 15) have been shown to be an effective means of creating accessible transport for some disabled users.

Lift equipped high-floor buses also have been deployed on major routes as part of an integrated network of accessible bus, rail and pedestrian infrastructure in some cities in Latin America.

Where wheelchair lifts are used they must have a safe working load of 300 kg and be at least 750mm wide and 1200mm long when deployed. Guardrails are needed along the sides and roll stops at least 100mm high are needed to provide security for a passenger using a wheelchair.

### *Wheelchair space*

If wheelchair users can enter the bus without leaving their chair, there should also be a space inside the bus for them to travel in their wheelchair. The number of wheelchair bays required will depend on the demand for them; in Europe and North America up to two spaces are provided in city buses. Doorways should be 850mm wide to allow a



**Figure 3.40** A slide-door wheelchair lift in use in Pretoria, South Africa  
(Source: CSIR)

wheelchair through. A recommended clear width of 750mm from the doorway, past the wheel arch area through to the wheelchair bay should be provided. Wheelchair users can travel either facing forwards or backwards, but never sideways, as the wheelchair can tip over much more easily and become a hazard for the occupant and other passengers in case of sudden braking. The recommended dimensions for a wheelchair space are shown in Figure 3.38.

Rearwards facing wheelchair spaces should be located such that a user can back up against a head / back restraint that can absorb an impact in the event of an accident.

A vertical pole on the aisle side of the wheelchair space and a horizontal handrail on the side of the vehicle helps the wheelchair user to manoeuvre into the correct position. Rearward facing wheelchairs are not usually secured to the floor with extra tie-downs.

However, this practice is limited to larger buses in fixed route service and depends also on an assurance that they are driven safely by well-trained drivers. In buses that travel at higher speeds, forward facing wheelchair

spaces should be used, and should be anchored to the vehicle using tie-downs for safety. Wheelchair securements (see Figure 3.41) should also be used when a variety of other factors indicate that they are needed for safety.



**Figure 3.41** The wheelchair and passenger are both restrained in a vehicle using a 4-point restraint (*Source: Unwin Safety Systems*)

Experience has shown that, typically, providing a wheelchair space does not actually decrease the capacity of the bus, as the space can be used by standing passengers if no wheelchair user is present. Alternatively a side-facing hinged seat can be installed that can be folded away when the space is needed by a wheelchair user.

The wheelchair space should be clearly marked as such and give wheelchair users priority.

#### *Bell pushes*

In buses that stop on request only, bell pushes can be very useful to signal a request for the next stop. This makes it not only much easier for speech and hearing impaired people to use the bus, but also safer for all passengers – and disabled passengers in particular – by not having to leave their seat while the bus is moving. Electronic bell pushes that can be pressed with the palm of the hand are preferable as they assist people with arthritis and rheumatism. However, mechanical systems that are activated by pulling on a cord can also be used if other options are not available. Bell pushes should preferably be available throughout the

bus, not more than 1500mm above the floor for standing passengers, but should at least be installed next to prioritised seats. To reduce anxiety and aid hearing impaired passengers, many bell systems light up a 'STOPPING' sign in the front of the bus when the bus is servicing a bus stand en route.

### *Signage and information*

Clearly legible destination and route number displays on the outside of the bus are essential for partially-sighted passengers to identify their bus, and helpful for all passengers especially at night. Both the route number (if used) and the destination are most important on the front of the bus (to help identify an approaching vehicle), but displaying the route number on the side (to confirm the information) and the back (to help confirm whether a bus was missed) is also very helpful.

Signage should be printed using lower case letters at least 200mm high (for route numbers) or 125mm high (for destinations). White or bright yellow letters against a black background are most clearly visible, especially for visually impaired passengers. Signage is best mounted above the windscreen where it is not hidden by other traffic, but cheaper options such as printed signs fastened to the inside of the windscreen are also possible provided they remain clearly legible.

### *Driver operation*

Drivers and conductors can greatly increase the usability of bus services to older and disabled passengers by observing some simple operational guidelines. Accessible design features will not help much if passengers are first required to jump on board a moving vehicle or to cross lanes of moving traffic before boarding. Reliability and predictability of the service is very important to many disabled people including vision and intellectually impaired people. Predictability can be enhanced by consistently stopping the vehicle close to the kerb and next to the bus pole at stops. Drivers should call out major stops, transfer points, or the end of the line, some time before arriving at the stop. This greatly assists visually impaired passengers, for whom the need to identify the correct stop at which to alight is a major barrier. The practice also benefits occasional users and tourists. If no amplification system is available, the announcement should at least be audible in the front of the bus (where prioritised seating should be provided).

Driving behaviour is also very important: a well-driven bus with smooth acceleration and deceleration (i.e. without sudden jerks and hard braking) increases safety and comfort for all passengers. The driver should also wait until all passengers (and specifically frail, older and disabled passengers) are seated before starting to move from a standing position.

## *Fare policy*

Many governments have the practice of subsidising bus travel for disabled people by charging them at reduced fares or no fare at all. While this is undoubtedly helpful to overcome affordability barriers among the poorest of disabled users, the issue of introducing concessionary fare policies should be considered with caution to ensure it does not act as a substitute for other (physical or operational) improvements to the bus service that could be more cost-effective.

## **Where to start?**

The most inexpensive way to incorporate good practice features into buses is to include them as specifications when new vehicles are ordered. Bus manufacturers should be able to include at least adequate handrails and stanchions, correctly designed signage of route number and/or destination, colour contrasted step noses and handrails, bell pushes, and a well-designed priority seating area at marginal cost. Every effort should also be made to improve the design of entrances and steps to better serve all ambulatory passengers, especially with regard to steepness and the height of steps.

But operators can install very useful features even on existing vehicles, at low incremental cost. The features mentioned above can improve the ability of many ambulant disabled people to travel by bus, even if the bus still has a very high floor. As a starting point, the features above could be concentrated around the front entrance/exit door, extending only as far as the priority seating area behind the driver – this will not serve all passengers, but at least target those who could benefit most. As a measure to overcome overcrowding that is endemic on many bus systems, the reserving of priority seats and the use of a priority entrance by disabled and older passengers can be considered.

Improving operating practices is another low-cost intervention – but it will need some amount of retraining and supervision of drivers and conductors. Practices such as the calling out of major stops, consistently drawing up close to kerbs (where possible), considerate driving habits, and generally cultivating awareness of the needs of passengers with disabilities, will work best in the context of a general improvement in customer orientation in bus services (see Section 16 for good practices on training).

Full access, including for wheelchair users, can incrementally be achieved through a combination of better bus design, on-board equipment, and infrastructure upgrading. Whichever of the options for wheelchair access are appropriate, these could first be deployed along major corridors (or accessible networks) with the highest potential for serving people with disabilities, and later extended as funds allow. This



**Figure 3.42** Low-cost improvements to this bus entrance included installing extra handrails, colour contrasted steps and lighting

would allow time to ensure that bus stops and the infrastructure surrounding them also do not present barriers to wheelchair users. Making one route fully accessible is usually preferable to having every second or third bus being accessible on a variety of routes. Disabled persons may take a few months to become accustomed to accessible public transport and, as with all passengers, reliability is needed in order for passengers to gain confidence in the service and for usage to grow.

### Further references

- Official Journal of the European Communities (2003). Directive 2001/85/EC of 20 November 2001 (Bus and coach directive), OJL 42 of 13.2.2003. (Retrieved: 2003, from [http://europa.eu.int/eur-lex/pri/en/oj/dat/2002/l\\_042/l\\_04220020213en00010102.pdf](http://europa.eu.int/eur-lex/pri/en/oj/dat/2002/l_042/l_04220020213en00010102.pdf) and [http://europa.eu.int/eur-lex/en/dat/2003/l\\_125/l\\_12520030521en00140014.pdf](http://europa.eu.int/eur-lex/en/dat/2003/l_125/l_12520030521en00140014.pdf))
- COST (1995). The low floor bus system. Final report of the Action Group. COST 322. Brussels: EC DG VII.

- Department of the Environment, Transport and the Regions (2000a). The Public Service Vehicles Accessibility Regulations 2000 Guidance. London: Department for Transport. (Retrieved: 2003, from the Mobility and Inclusion Unit, Department for Transport. [www.dft.gov.uk](http://www.dft.gov.uk))
- Department of the Environment, Transport and the Regions (2000b). The Public Service Vehicle Accessibility Regulations 2000. Statutory Instruments 2000 No. 1970. London: The Stationery Office. (Retrieved: 2003, from [www.legislation.hmso.gov.uk](http://www.legislation.hmso.gov.uk))
- Disabled Persons Transport Advisory Committee (DPTAC) (1996). Re-statement of Recommended Specification for Buses used to operate Local Services. DPTAC: London. (Retrieved: 2003, from [www.dptac.gov.uk](http://www.dptac.gov.uk))
- European Conference of Ministers of Transport (1999). Improving transport for people with mobility handicaps: a guide to good practice. Paris: OECD.
- Le Claire M, Visvikis C, Oakley C, Savill T, Edwards M, Cakebread R (2003). The safety of wheelchair occupants in road passenger vehicles. Crowthorne: TRL Limited. (Retrieved: 2003, from [www.dft.gov.uk](http://www.dft.gov.uk))
- UNESCAP (United Nations Economic and Social Commission for Asia and the Pacific) (1995). Promotion of non-handicapping physical environments for disabled persons: guidelines. New York: United Nations

## 10 Mini / midibuses

---

*Vehicle accessibility varies along with the range of vehicle designs: public transport services are increasingly provided by informal public transport operators who operate midibuses, minibuses, motorised rickshaws, and other informal vehicles. A defining characteristic of these services is that they are typically provided by a large number of individual owners or operators who hire/rent the vehicles on a daily basis and hence have to guarantee the daily income to the owner before generating income for themselves. The vehicles operate on relatively flexible routes and schedules, and authorities typically have very little regulatory control over them. While some vehicles have relatively low floors easing entry and exit, others are harder to board or alight due to an absence of steps and handrails and narrow doors. Major problems exist around the way they are operated – fiercely competitive operating conditions often leads to overloading and to a refusal to stop for disabled people due to a perception that they will prolong boarding time; and to speeding and unsafe driving habits. However, the informal nature of this mode also means that some drivers are willing to go out of their way to serve passengers with particular needs, especially if they have built up a relationship with them.*

*It is precisely the informal nature of mini/midibus operations that makes them difficult to improve – vehicles are often second-hand and governments in practice have little control over their specifications. If government is involved as a provider of infrastructure to the industry (such as stopping points and ranks), some access improvements along the lines of those described in Section 9 can be helpful to passengers. But, clearly, the only way improvements can be made to the accessibility of vehicles – either through government-sponsored renewal of fleets (see Box 3.6 and Box 3.7), or incrementally as vehicles are slowly replaced – is predicated on governments succeeding in establishing stronger regulation and formalisation of the industry, both in terms of vehicle standards and of operating practices. Only then will it be possible to comprehensively address accessibility issues in small vehicles. The guidelines mentioned here are thus likely to be useful particularly in situations where sufficient progress is being made with formalising/stabilising the industry so that providing a better service becomes a priority to operators.*

## Basic principles

### Safety:

- Unobstructed space for wheelchair users to travel in their chairs (if possible).
- Wheelchairs should be restrained where possible.
- Smooth driving and braking to avoid injury.
- No hazards or sharp edges that could injure passengers.
- Single width ramp preferred to help wheelchair users board.
- Boarding devices should be available if wheelchair spaces are available.
- Handrails and steps highly visible.
- Seats near entrance available for disabled passengers.
- Easy stowage of mobility aids (wheelchairs, walking sticks).
- Clear signage indicating route/destination and fare.

### Reliability:

- Drivers consistently stop to pick up disabled passengers.
- Drivers and helpers providing helpful service and assistance.
- Clear announcement of stops requested by passengers.

### Accessibility:

- Easy and unhindered boarding via steps.

### Affordability:

#### To the Provider:

- Include low-cost access features as requirements in concessioning agreements (where relevant).

#### To the User:

- Prohibit extra charges for carrying wheelchairs and other aids.

## Good practices

### *Vehicle entrance/exit*

To provide easy entrance for ambulatory passengers, the entrance to all vehicles (regardless of their size) should follow good practice guidelines. These include:

- Door width at least 800mm between hand rails.
- Steps at least 400mm wide, 280mm deep, and the first step at 250mm above ground level, other steps 200mm high.

- Sufficient handrails provided on both sides of the entrance, reachable from ground level all the way to the inside of the vehicle.
- Step edges (noses), handrails and top of door opening painted in a bright contrasting colour (see Figure 3.43).

If wheelchairs are being accommodated these dimensions should be increased in accordance with the guidelines given for buses (Section 9).

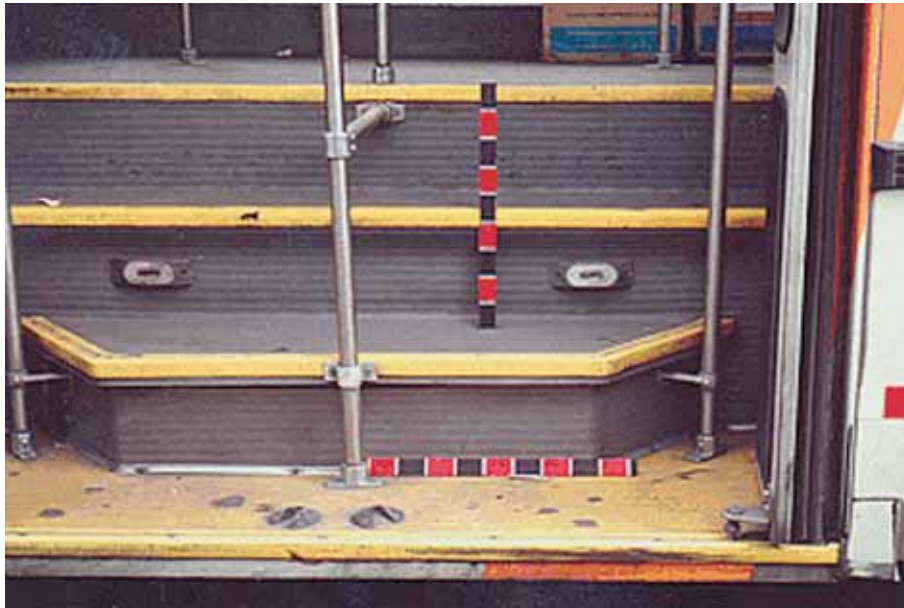

**Figure 3.43** The rear entrance of newly deployed midibuses in Mexico City feature good colour contrast and wide doorways

### *Seating*

Seating should provide sufficient space for people with walking difficulties to manoeuvre easily. Legroom of at least 230mm (300mm for priority seats), and seats of about 450mm wide are ideally required to achieve this (see Figure 3.38). If these dimensions can be achieved only in one place (such as the seats directly behind the driver), a sign should indicate that these seats are prioritised and should be vacated for older and disabled passengers. Mini- and midibuses are not usually fitted with seatbelts (besides the driver), but where these can be installed (for instance at priority seats) it will improve the safety and comfort for disabled passengers.

### *Access for wheelchair users*

Providing wheelchair access into existing minibuses is problematic due to the narrow doors, low roof heights and limited internal manoeuvring space typical of these small vehicles. The high costs of converting

vehicles is therefore likely to limit wheelchair access to special programmes using specially designed and subsidised vehicles.

Midibuses with floor heights not exceeding 500mm may however be large enough to provide direct access for wheelchair users via a short ramp. The South African Federal Council on Disability has, for instance, recommended that new midibuses to be used in taxi services provide portable ramps at a gradient of 1:4, but this steepness requires an assistant to push the wheelchair user into the vehicle (*SAFCD, 2001*). The 2 metre-long ramp has to be stowed safely inside the vehicle. Since these vehicles are custom-designed for public transport services, sufficient interior space can be provided for a wheelchair user, in combination with a foldable seat. The wheelchair space dimensions given for buses (Section 9) can be modified in consultation with local users to ensure the majority can use it.

A passenger lift can also be fitted to a separate entrance to facilitate boarding. The lift should have a load bearing capacity of 300kg and a platform size of at least 750mm wide and 1200mm long. Colour contrasted handrails on both sides and a 100mm sill should be available.

Even if floor heights or space constraints preclude provision of wheelchair access, it may still be possible for a user to transfer to a regular seat with help. Vehicles should at least have space for a folded wheelchair to be stowed safely.

Ideally, appropriate wheelchair and passenger restraints (where seatbelts are provided) should be used as described in Section 9.

### *Signage*

Clear and legible signage is important for all passengers to identify the correct vehicle to board or hail. Route numbers or destinations should be prominently displayed on vehicles (see Section 14 for good practice regarding colours and sizes). The use of colour coding to indicate different routes or different origin and destination points has worked well in South Africa and helps not only some low-vision passengers but also people who are illiterate or unfamiliar with the system (see Figure 3.44).

### *Communication*

Communication inside the vehicle between passengers and drivers/assistants is critical, as the vehicle typically only stops when requested or hailed by a waiting passenger. The small size of the vehicle usually aids easy communication between passenger and driver. But for visually impaired people it is problematic to identify when they are approaching



**Figure 3.44** Colour coded destination signage used on minibuses in some parts of South Africa

their desired location, while hearing and speech impaired people find it hard to communicate their desire to stop. These problems may be partly addressed by installing a bell push centrally in the vehicle (see Section 9 for good practice), and by training drivers to proactively ask visually impaired people for their destination when they enter the vehicle, and to announce when they are nearing the destination.

#### *Operating practices*

Authorities can improve affordability and combat unfair discrimination by prohibiting minibus drivers to charge extra for the passage of wheelchairs, walking frames or other equipment needed for personal mobility. It is also particularly important for drivers to be courteous and aware of the needs of people with disabilities – more so perhaps than with formal systems, because operating practices are less formalised and therefore depend more on the judgment and attitude of the driver. This can be achieved by instilling greater awareness through training (see Section 16), monitoring, incentives and contracting arrangements (see Box 3.6). An effective enforcement mechanism may be to advertise a telephone number for passengers to lodge complaints or compliments, with effective feedback to drivers both positive in the form of incentives and negative by means of criticism.

#### **Where to start?**

As mentioned above, the first step towards improving safety and accessibility for all passengers of informal services, including those with

disabilities, is to start fostering greater accountability of the industry. This requires coordinated approaches to creating partnerships with government, formalising routes and services, stabilising operating conditions, stepping up enforcement, and empowering customers. As with larger capacity buses, the retrofitting of existing vehicles with low-cost features such as handrails, adequate signage and colour contrasting can benefit many passengers and should be pursued if circumstances allow. But in practice opportunities for such interventions are severely limited by operators' financial inability to invest in vehicles they do not own.

More effective ways of improving vehicle standards are for government regulators to require higher standards of *new* vehicles used for public transport services. This can also be undertaken in an incremental manner, starting with some of the low-cost features described above to assist ambulatory passengers, and incorporating wheelchair access in some portion of the fleet. In some cases Governments have become involved in subsidising the replacement of vehicles, and using this opportunity to specify significantly higher standards for access, (see Box 3.7).

Whether vehicle design is improved incrementally or through large-scale Government-sponsored replacement programmes, it is important that the operating practices of drivers be addressed through adequate training and monitoring.

### **Box 3.7 Improving access through micro substitution programme in Mexico City**

The Federal District of Mexico City is achieving greater accessibility in their informal *micro* fleet by buying back older vehicles and substituting them with newer, somewhat larger, midibuses. The city pays owners 100,000 pesos (around US\$11,000) for their old *micros* which are considered over-aged, polluting, and inefficient. The owner can then use this sum as a down payment on a newer vehicle, which has design features to improve its accessibility to the 90-95% of disabled persons who are not wheelchair users. These features may include wider entrances, better hand holds, better interior layout with more space, priority seating behind the driver, and use of colour contrast.



*Figure 3.45 One of the mid-size buses replacing old micros in Mexico City*

### Box 3.8 Auto rickshaws and motorcycle taxis

Auto rickshaws are small three-wheeled vehicles which run on a motorcycle or scooter engine. Motorcycle taxis are similar but use two-wheeled vehicles. Auto rickshaws and motorcycle taxis are used to provide a widely used taxi service in many towns and cities in South Asia and Africa. Their wide availability and door-to-door service make auto rickshaws competitive with bus and rail services in Asian cities. Rickshaws generally charge a metered fare, but in



*Figure 3.46 The auto rickshaw is widely used in South Asian cities for taxi-type transport*

many Indian cities the fare is negotiated between the driver and the passenger.

In some cities in Africa, bicycles are used as taxis and are a major source of employment as are auto rickshaws in India.

Auto rickshaws and motorcycle taxis are an important mode of mobility for many disabled and older people.

Auto rickshaws are easier to board than buses because their steps are lower. Their door-to-door services allow users to overcome many of the barriers of an inaccessible built environment, and services can sometimes be personalised, with passengers entering into agreements with operators to provide regular trips.



*Figure 3.47 Boda Boda cycle taxi, Uganda*



*Figure 3.48 Motorcycle taxi, Thailand*



*Figure 3.49 Boda Boda motorcycle taxi, Uganda*

*Continued ....*

### Box 3.8 (Continued) Auto rickshaws and motorcycle taxis

Auto rickshaws can be improved to provide better access. No good practice exists in this regard, but various small-scale projects have come up with designs for more accessible vehicles. Additional improvements may include:

- Using colour contrast to highlight handrails and step noses.
- Redesigning the entrance to allow users to transfer directly from a wheelchair (including grabrails).
- Training of drivers to communicate better with people with hearing or visual impairments.



*Figure 3.50 Experimentation to the development of this wheelchair accessible bicycle rickshaw. Photo by the Bikash Bharati Welfare Society in India (Courtesy of Lalita Sen)*

It is important that wheelchairs are safely restrained in vehicles, especially if the passengers travel seated in their wheelchairs



*Figure 3.51 Side and rear view of a 3-wheeled motorcycle turned into a prototype accessible van (Courtesy of Wycliffe Kepha)*

## Further references

- Disabled Persons Transport Advisory Committee (November 2001). Accessibility Specification for Small Buses designed to carry 9 to 22 passengers inclusive. London: DPTAC. (Retrieved: 2003, from [www.dptac.gov.uk](http://www.dptac.gov.uk))
- Department of the Environment, Transport and the Regions, the Scottish Office and Department of the Environment for Northern Ireland (1997). Disability Discrimination Act 1995. The Government's proposals for taxis. An informal consultation document. London: Mobility Unit, Department for the Environment, Transport and the Regions. (Retrieved: 2003, from [www.dft.gov.uk](http://www.dft.gov.uk))
- Disabled Persons Transport Advisory committee (DPTAC) (December 2003). Making private hire services more accessible to disabled people: a good practice guide for Private Hire Vehicle operators and drivers. London: DPTAC. (Retrieved: 2003, from [www.dptac.gov.uk](http://www.dptac.gov.uk))
- European Conference of Ministers of Transport (1999). Improving transport for people with mobility handicaps: a guide to good practice. Paris: OECD.
- South African Federal Council on Disability (2001). Broad summary of requirements for special universal access on taxi vehicles. Cape Town, South Africa.

## 11 Design and operation of trains

---

*This section deals with the design and operation of heavy rail vehicles operated in some cities of the developing world, including those used in providing urban, suburban, and metro/underground services. Many of the guidelines provided here – as well as those on rail infrastructure in Section 12 – can also be applied to other variations of rail transport, such as light rail and trams.*

### Basic principles

#### **Safety:**

- Unobstructed space for wheelchair users to travel in rail carriage[s].
- Smooth acceleration and deceleration to avoid injury.
- Personal security enhanced through good lighting and surveillance.
- Ramps should preferably be single width.

#### **Reliability:**

- All advertised accessibility features available and working.
- Train (or at least accessible carriage[s]) stops in same place every time.
- Clear announcement of stations being approached.
- On-board staff providing helpful service/assistance.

#### **Accessibility:**

- Level boarding for wheelchair users into train or boarding devices should be provided (e.g. lift or ramp).
- Easy and unhindered boarding via steps (if any).
- Handrails/holds, steps and hazards highly visible.
- Seats near entrance available for disabled passengers.
- Easy storage of mobility aids (wheelchairs, walking sticks).
- Clear signage indicating train destination.

#### **Affordability:**

##### To the Provider:

- Start by implementing low cost features on designated carriages.
- Upgrade one car per train for better access.

##### To the User:

- Concessionary fares could be considered.

## Good practices

### *Boarding for wheelchair users*

Providing direct and level boarding for wheelchair users and others is best practice if the platform and train floor are at the same height. A temporary approach is to construct a partially raised platform where carriages that accommodate wheelchair users stop, or provide a portable ramp.



**Figure 3.52** (Near) step-free entry into the Buenos Aires railway carriage

An unobstructed door width of at least 800mm is needed to allow entry to wheelchair users (850mm in the UK) – in some systems a vertical pole in the doorway prevents achievement of this clear entry width. In order for the gap between the platform and the car floor not to be unmanageable for wheelchair users or unsafe for visually impaired people, a maximum horizontal gap of 50mm, is recommended. This may not be achievable in older systems, or when the train station is built on a curve in the line, but it should be considered an ideal.

An attention to level boarding is the use of portable hand-operated lifts, such as the one shown in Figure 3.53. This is a cost-effective option as only one is required per platform, and it can be wheeled to the desired boarding point when required. Train-mounted lifts – a more expensive option – are also increasingly used, but these require careful design to fit within the specific train car dimensions. A ramp (preferably single width) could also be used ideally with a maximum gradient of 8%.



**Figure 3.53** Portable lift used in North American rail stations (*Source: Adaptive Engineering*)

Train doors should open automatically or when the passenger presses a button on the outside or inside. On the outside the button should be mounted less than 1300mm above the floor, raised from the surrounding area by at least 3mm and it should be big enough to be pressed by the palm (about 20mm diameter).

#### *Boarding using steps*

The design of steps and stairs, to ensure they can be used by the largest number of ambulant people, should follow the guidelines given for buses (Section 9). This includes the use of handrails and colour contrasting, both of which are very important.

#### *Layout of carriage*

Guidelines for the interior layout of rail carriages are similar to those for buses (see Section 9): adequate passageway widths, space allocated for one or two wheelchair passengers, priority seating near entrances/exits, and colour contrasted handrails and step edges. Wheelchair spaces should be located close to the entrance, and could be facing forward or backward. Typically no restraint is provided other than the wheelchair brakes. Wheelchair spaces may be usable by other passengers when no wheelchair is present, such as those with pushcarts, bicycles, or seated passengers (if a hinged seat is installed).

### *Accessible carriages*

Entry and exit from very overcrowded trains can be very hard for disabled passengers. It is the practice in some systems to reserve one carriage or one section of a carriage for disabled people. This practice does, however, raise security concerns due to the isolation of some passengers from the watchful eye of others – it is best to locate the reserved carriage next to the driver or conductor’s cabin. However, where possible, facilities for disabled people, in particular people with ambulant disabilities, should be available in all carriages.



**Figure 3.54** An unobstructed train carriage interior with improved colour contrast and grabrails, Cape Town, South Africa (*Source: Charles O’Leary, courtesy of Modalink*)

### *Signage*

If a station serves more than one train line, the name of the line or the destination of the train, on the front of each train should be displayed. Good practice guidelines regarding signage discussed in Section 14 should be followed. Line or destination information should preferably be repeated on the side next to train doors, in case passengers missed the signage on the front.

Inside the carriage, diagrams indicating major stops served on a line can be very helpful to hearing impaired passengers and tourists

### *Communication*

On-board announcement of the next stop before the train arrives at the station is very helpful to all passengers, but especially to visually

impaired passengers. A public announcement (PA) system is typically needed for this. PA systems are also valued by all passengers for providing details of delays and emergencies. If no PA system is available, it becomes even more important to ensure the platforms display the station name clearly and legibly at every station. Visual signs especially, benefit people with hearing impairments.

### *Fare policy*

As with bus systems, many governments have the practice of subsidising rail travel for disabled people by charging them reduced fares or no fare at all. While this is undoubtedly helpful to overcome affordability barriers among the poorest of disabled users, the issue of introducing concessionary fare policies should be considered with caution to ensure it does not act as a substitute for other (physical or operational) improvements to the rail service that could be more cost-effective.

### **Where to start?**

As with all modes of transport, the improvement of access to train carriages needs to be coordinated with access features on related infrastructure. It may be possible to start with upgrading carriages used on one line, and to coordinate that with incremental access improvements to major stations on that line. This is especially important if wheelchair access is to be provided, as it helps little if carriages are wheelchair accessible but wheelchair users are barred from getting to the platform by flights of stairs.

It is usually hard to significantly improve the accessibility of train carriages short of major refurbishing or rebuilding of carriages – especially with regard to carriages with doors and passages too narrow to admit a passenger using a wheelchair. New train carriages should be built to conform with the access norms. Meanwhile, small incremental steps will assist all passengers, such as installing extra handrails and colour contrasting step noses at entrances, assigning priority seats near the entrance for disabled passengers and announcing upcoming stops. Improvements can be phased in by providing at least one accessible carriage per train. Provided passengers with disabilities know about this, it is not necessary to upgrade a whole train before some benefit can be gained. It is important that these carriages be clearly identified, and that they are consistently placed in the same location in the train, to enable users to wait in the correct spot on the platform. Locating them close to the driver or conductor will also maximise security and the possibility of providing assistance where it is needed.

Finally, helpful staff at stations and on-board trains can be extremely useful in assisting passengers to overcome some of the access barriers that remain.

### **Further references**

- COST (1999). Passengers accessibility of heavy rail systems. Final report. COST 335. Brussels: EC DG VII. (Retrieved: 2003, from [www.cordis.lu/cost-transport/src/cost-335.htm](http://www.cordis.lu/cost-transport/src/cost-335.htm))
- Department of the Environment, Transport and the Regions (2000). The rail vehicle accessibility regulations 2000. Statutory Instruments 2000 No. 3215. London: The Stationery Office. (Retrieved: 2003, from [www.legislation.hmso.gov.uk](http://www.legislation.hmso.gov.uk))
- Department for Transport Local Government and the Regions (DTLR). (2002). The rail vehicle accessibility regulations guidance. London: Department for Transport. (Retrieved: 2003, from [www.dft.gov.uk](http://www.dft.gov.uk))
- European Conference of Ministers of Transport (1999). Improving transport for people with mobility handicaps: a guide to good practice. Paris: OECD.
- Leake G R, May A D and Parry T (1991). An ergonomic study of pedestrian areas for disabled people. Contractor Report CR184. Crowthorne: TRL Limited.

## 12 Bus and train stations

---

*This section deals with transport buildings such as train stations, bus stations and bus terminals. Although primarily aimed at buildings serving urban bus and rail services, these guidelines could be equally applicable to intercity services. Train stations that are not at the end of a line are often challenging to make fully accessible due to the need for trains and passengers to move on different levels. Judicious use of ramps can, however, provide affordable solutions. Improving existing stations and terminals can thus be high on the priority list: despite the higher cost (as compared to bus stops), there are fewer of them, and high passenger volumes can often guarantee high impacts.*

## Basic principles

### Safety:

- Waiting area (platforms, kerbs) separated from vehicles.
- Tactile warnings near to, and white line, on rail platform edge.
- Personal security enhanced through good lighting and design.
- Steps should not have open risers as these are a trip hazard.

### Reliability:

- Lifts, stairlifts etc. in good working order and operator available (where applicable).
- Real-time information on service changes or delays available in written and audible formats.
- Trained staff, available to provide assistance.
- Accessible walkway between station and surrounding footways.

### Accessibility:

- Shelter and seats, especially if area prone to rain or extreme heat/cold.
- At least one barrier-free access route into building and onto platform - no stairs, obstacles, vendors.
- Simple layout and clear information to help navigate to correct platform/bay.
- Kerb or platform at correct height to ease entry into vehicle (in combination with correct vehicle design and user-friendly operation).
- Access to ticket counters, toilets, kiosks and other facilities.

### Affordability:

To the Provider:

- Minimise costs by including access features on new/ upgraded stations.
- Maximise impact by installing access features in high use stations first.

## Good practices

### *Entrances*

A single step outside the doors of a transport facility can make the whole building inaccessible to some disabled people. Although it is preferable to make all entrances fully accessible, this is not always practical and in such cases entrances to be made accessible should be carefully chosen (for instance at least one accessible entrance on each side of the rail line). An accessible entrance has the following features (see Figure 3.55):

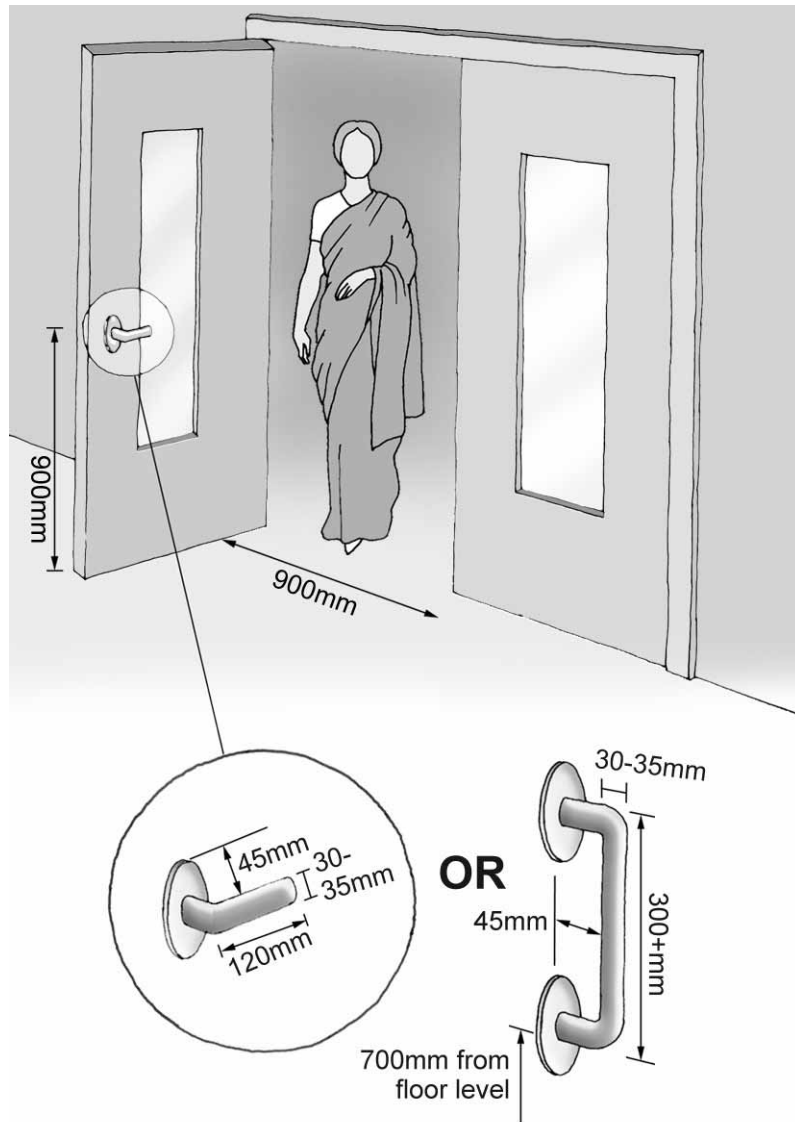

**Figure 3.55** Dimensions for accessible doorways (Based on Oxley, 2002)

- Step-free access between street level and doorway (see ramps below). Thresholds should be no more than 10mm high so as not to preclude wheelchair users from entering.
- A level landing at least 1500mm long is needed in front of the entrance to avoid wheelchair users (and other users) having to balance themselves on a slope while opening the door.
- Entrance wide enough (at least 900mm) and unobstructed by turnstiles.
- If doors do not open automatically, it should be possible to open them with minimum effort. Lever or loop-type door handles are much easier to use than knob handles, and should be colour contrasted to the door.

- Door or door frame in contrasting colour to building. If a fully glazed door is used it should include white or yellow bands at eye height.
- Entrance should be marked as accessible using the international symbol.
- Non-accessible entrances should bear a sign directing passengers to the nearest accessible entrance.

### *Layout of station*

A simple and compact layout makes stations and terminals easy for visually impaired, cognitively impaired, and occasional users/visitors to navigate through and it also minimises walking distances. Wherever possible passengers should not have to cross the path of vehicles – passenger areas should be clearly delineated (for instance by raised kerbs) to separate passengers from vehicle traffic. Wherever passengers do need to cross the path of buses, clearly marked crossing points, with level access and priority for pedestrians is essential.

### *Ramps*

Ramps are usually the best way to provide wheelchair access between different floor levels – such as between overhead walkways and platforms – as they are much cheaper to install and maintain than lifts, and can serve almost everybody. Having the correct gradient is very important: an overly steep gradient can render a ramp too dangerous and inaccessible for wheelchair users and many others. Figure 3.56 shows the major recommended dimensions for ramps.

As stated in Section 5 most guidelines specify 5% (1 in 20) as the preferred gradient, and 8% (1 in 12) as the maximum acceptable. However although not recommended it may be necessary to provide short ramps (1000mm or less) with slopes of up to 10% to meet local constraints.

The steeper the gradient, the shorter the distance that most wheelchair users can cover without resting. Table 3.6 shows the maximum preferred horizontal distances for different slopes. In all cases, individual ramps should not be longer than 10 metres. Resting places in between should be level, at least 1200mm (preferably 1500mm) long, and the full width of the ramp. Level and unobstructed landings at the foot and head of a ramp should be at least 1200mm long.

Handrails should preferably be provided on both sides, to cater for people with different body strengths on their left and right sides. (See below for more on handrails.) The sides of the ramp (if not against a wall) should be protected by a solid raised kerb at least 75 to 100mm high.

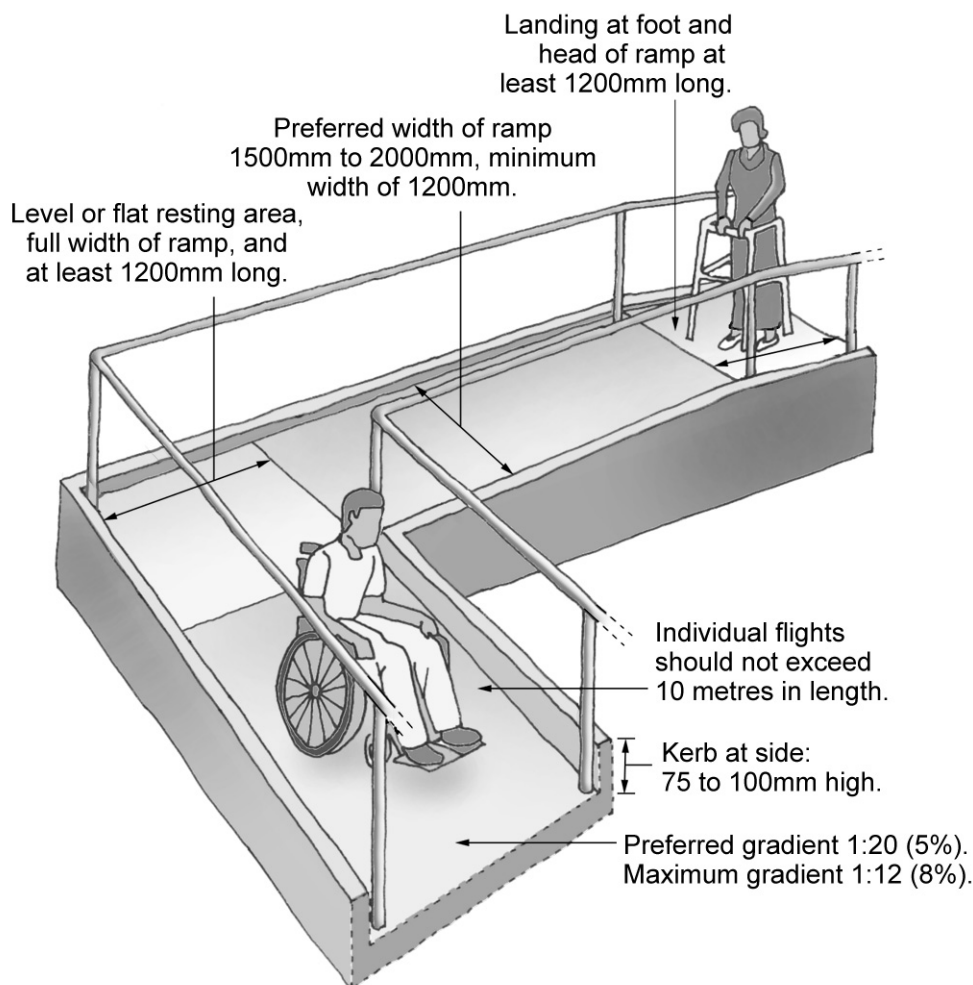

**Figure 3.56** Layout and dimensions for ramps (*Based on Oxley, 2002*)

**Table 3.6 Recommended gradients and lengths of ramps**

<i>Gradient of ramp</i>	<i>Recommended Use</i>	<i>Maximum horizontal length</i>
10 per cent (1 in 10)	Very short distances only.	<b>Less than 1 metre.</b>
8 per cent (1 in 12)	Maximum slope for general use.	2 metres.
5 per cent (1 in 20)	Preferred slope.	9 to 10 metres.

(*Source: Based on Oxley, 2002*)

Some level changes are so great that ramps of very long lengths would be required to bridge them. European guidelines (*ECMT, 1999*) recommend that ramps should never be longer than 132 metres in total, as the extra distance they add becomes too burdensome for many people. However, the alternative – installing lifts or stairlifts on each platform – may be too costly to achieve and it may be unavoidable to see long ramps used in many developing countries. Adequate resting places are then very important.

### Steps and stairs

Even though ramps or lifts are needed to provide access to wheelchair users (while benefiting many other passengers), the design of steps and stairs is also important to assist ambulant disabled people. It is usually desirable to have both a ramp and steps, especially if ramps are longer than 9 metres, as many people prefer to climb a shorter staircase than a much longer ramp. But if there is insufficient space for both, a ramp should be provided rather than stairs.

Recommended practice for steps and stairs is illustrated in Figure 3.57.

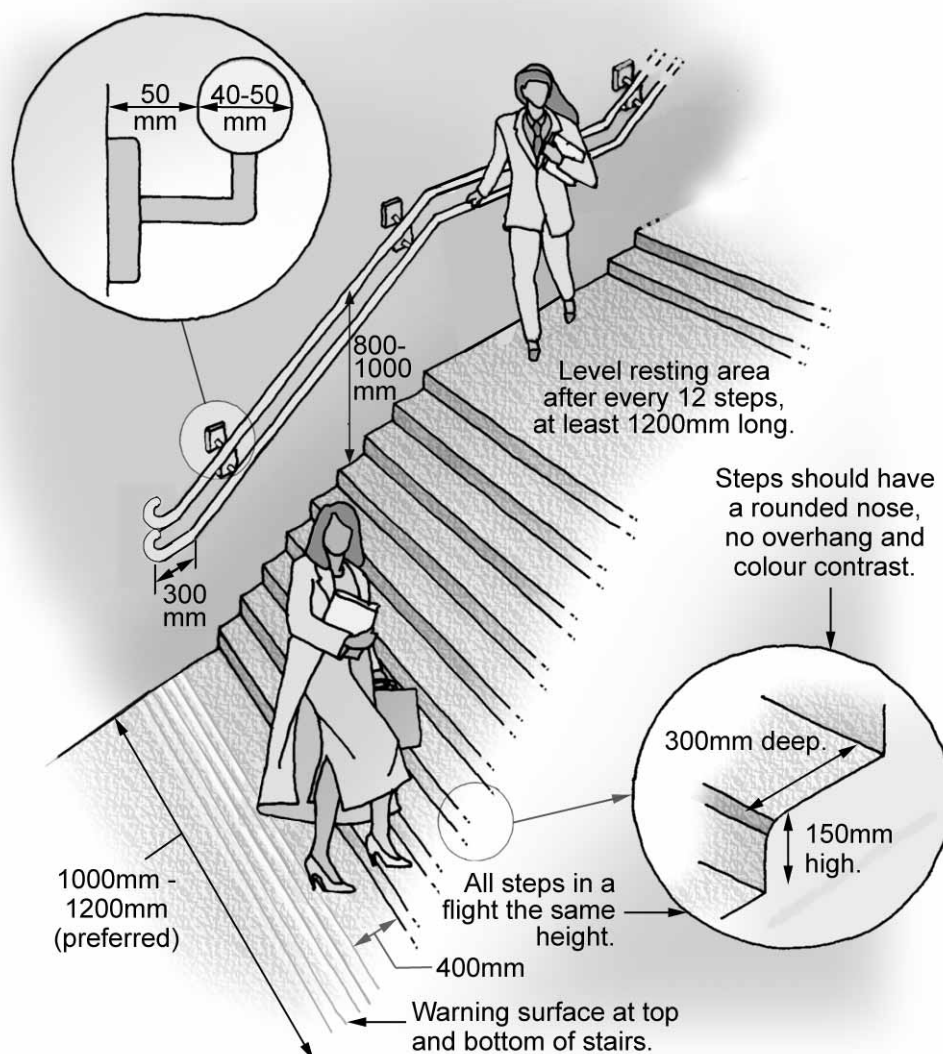

**Figure 3.57** Dimensions – steps and stairs (Based on Oxley, 2002)

- Steps should be 150mm high and 300mm deep to be manageable by most people. Risers should be vertical, round nosed, and should not have an overhang. Open riser staircases should not be used as these are a trip hazard.
- All the steps in a flight should have the same dimensions to avoid trip hazards.
- UK guidelines recommend the use of tactile warning surfaces at the foot and head of the stairs (see Section 5). The tactile surface should be 400mm deep and installed 400mm back from the step edge.
- The number of steps in a flight should be limited to 12, with resting places in between to assist people who cannot manage long flights of steps. Resting places should be at least 1200mm long.
- The clear width of stairways between handrails should be at least 1000 to 1200mm which is sufficient for a disabled person and companion and more if there is significant two-way movement.
- Handrails should be provided on both sides, and also in the centre if stairways are very wide (more than 1800mm). See below for handrail dimensions.
- Colour contrast (e.g. yellow or white paint on a dark background) on the step noses, and handrails is essential for visually impaired people.

The underside of freestanding stairs or ramps can present a collision hazard to people with visual impairments and other pedestrians. Where the clear height is less than 2100mm, the area should be protected by handrails or barriers.

#### *Escalators, lifts and stair lifts*

Good practice around the use of escalators relate to the width and height of stairs, the speed at which it moves, and provision of clear space at the head and foot. Escalators are difficult for some ambulant disabled people to use and do not provide for people using wheelchairs or guide dogs, and would therefore not negate the need for ramps or lifts to be installed. Stair lifts are sometimes used to move wheelchair users up or down stairways. They cost less than lifts, but can have significant operating costs as they usually require trained personnel to operate and maintain them.

Much research has been done to identify good practice in the design of lifts – many guidelines address the internal dimensions, location and type of control buttons, use of audible signals, and door opening times. While lifts are an expensive option, their cost can be justified in certain



**Figure 3.58** Stair lift used in the Mexico City Metro

circumstances by heavy passenger volumes (such as in major stations) or when there is a substantial change in levels. It must be remembered that, unlike stairlifts and escalators, well designed lifts serve everybody.

#### *Pedestrian clearways*

Passageways, and the spaces between seats, stalls, waste bins and so forth should be wide enough to provide adequate clear space for wheelchair users and others needing sufficient space. As indicated in Section 3, the minimum recommended width for two-way pedestrian flows is 1800 to 2000mm. Where this width needs to be restricted, it should never be less than a minimum 900mm and continue for more than 6m in length. A clear height of at least 2100mm is recommended. To assist visually impaired people hazards such as advertising boards, vendors and rubbish bins should be absent from the clear way. Objects that protrude more than 100mm into the clear space from the side should be protected and marked with two horizontal bands 150mm wide and placed at 800 and 1600mm from the ground.

#### *Handrails*

Handrails are extremely important features as many people with disabilities rely on them to maintain balance and avoid falling. Handrails are needed in queuing and waiting areas. Handrails should be fixed between 800mm and 1000mm above the stairs or ramp floor. They should be continuous along the ramp/stairs, and continue past the end of the ramp or stairway by at least 300mm and then be turned towards the wall or floor. Handrails should be made from circular tubing 40 to

50mm in diameter. Alternatively, other types of handrails should not be more than 50mm wide and have rounded edges (with no more than 15mm radius) to be most comfortable to people with arthritic hands and be smooth and without any sharp edges. The handrails should be fixed at least 50mm from the adjacent wall to prevent hands being caught between rail and wall. Rails should contrast with the surroundings (e.g. painted bright yellow) to assist partially sighted users.

### *Signage*

Clear signage throughout the building is important for everyone, particularly hearing impaired people. See Section 14 for more information on formats and requirements for signage.

### *Tactile and visual guidance*

In the absence of other cues, visually impaired people may be able to navigate through a station by following a tactile path. People with some vision generally focus on the floor up to 1500mm ahead. Directions to platforms, or warnings of stairs ahead should take this into account. As with footways, it is suggested that tactile and visual clues be used sparingly and consistently. The input of local users with disabilities may be invaluable in identifying appropriate approaches.

### *Platforms at rail stations*

Apart from being reachable by ramps or lifts, accessible platforms should also provide sufficient space and tactile clues for safe use (see Figure 3.59). UK guidelines recommend a minimum clear width of 2000mm but this should be increased if more passengers use the platform. A level and well-maintained surface is essential for safety. In order to warn visually impaired passengers that they are approaching the platform edge, it is good practice to install a tactile warning strip 400mm deep, set back about 500mm from the edge, and contrasting with the surrounding floor (see Section 5 for further information). A white line or equivalent warning along the edge of the platform should always be used to caution passengers. Equipment such as rubbish bins or information boards should be placed outside the clear space along the platform, and colour contrasted for high visibility.

If the practice is to designate one carriage in every train as an accessible carriage (see Section 11), and the carriage stops approximately in the same place every time, it would be good practice to indicate the corresponding space on the platform for disabled passengers to wait in.

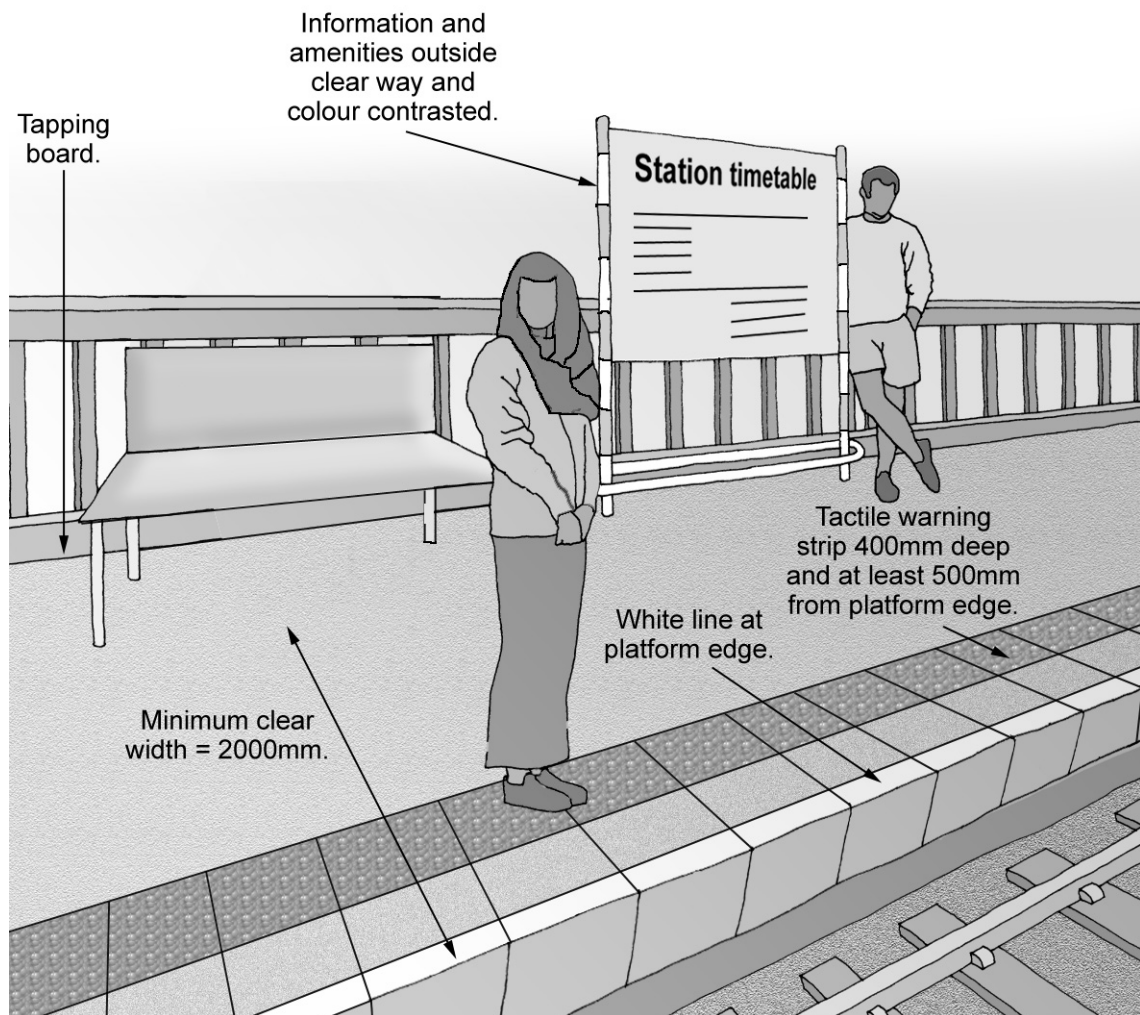

**Figure 3.59** Platforms at rail stations (*Source: OXLEY, 2002*)

### *Information*

Helpful and knowledgeable station personnel are needed to provide information and improve confidence for travellers with disabilities. Trained station personnel should be clearly identifiable (such as through distinctive clothing or badge), and available to answer questions. If the staff are behind a counter, the counter should be designed to be as user-friendly as possible (see below).

Information on train schedules should be displayed visually using best practice to improve legibility (see Section 14). In addition, it is important that information on any changes to the posted schedule, such as platform changes or delays, be communicated both visually and audibly. At its simplest, this can take the form of pre-printed cards stuck on a signboard; more expensive options include computerised message signs. Audible announcements should preferably be made with a public-announcement (PA) system. Even if no amplification is available, station

personnel should make every effort to inform passengers audibly of real-time changes, as this benefits all travellers, not just those with visual impairments.

### *Amenities*

Ticket-counters, ticket gates, telephones, waiting areas, and toilets can be designed to be accessible to all users. If **telephones** are provided inside the station, at least one telephone should be placed lower than the standard to allow for wheelchair users, children, and people of restricted height. The top of the unit should be about 1040mm above the floor. There should be enough clear space in front of the unit (about 1200mm for a wheelchair user) without blocking any clearways.

**Seating** should be provided for people who cannot stand for long, in waiting areas and on platforms if there is enough space. A good height for seats or benches is about 480mm above the floor. Some people find armrests helpful; these should be about 200mm above seat level if they are provided. To enhance visibility seats should be colour contrasting with the surroundings. For outdoor seats, the use of wire-mesh is a good way to prevent rainwater collecting on the seat. In waiting areas some seats should be reserved (and marked) for use by older and disabled people.



**Figure 3.60** Perch-type seats

Some (but not all) seating can consist of perch-type seating against which passengers can lean or half-sit for a while. They are simple and inexpensive to construct and maintain, unobtrusive, and attractive to people with arthritis or back problems who find it difficult to get up from a low seat. Perch-type seats should be about 700mm from the ground.

At least one ***ticket information counter*** needs to be low enough to be used by passengers in wheelchairs, children, and people of restricted height. A height of about 800mm is needed, with enough knee space below the counter for wheelchair users (about 500mm deep and 900mm wide). Clear space in front of the counter (free of queuing rails and other barriers) should be at least 1200mm. Since it can be very difficult for people with hearing impairments to hear the information officer through a glass window, at least one counter should be provided with an induction loop in situations where this is appropriate and include a sign to indicate as such. It is also a good idea to provide handrails along the area where people queue up, for passengers to lean against if they find it difficult to stand.

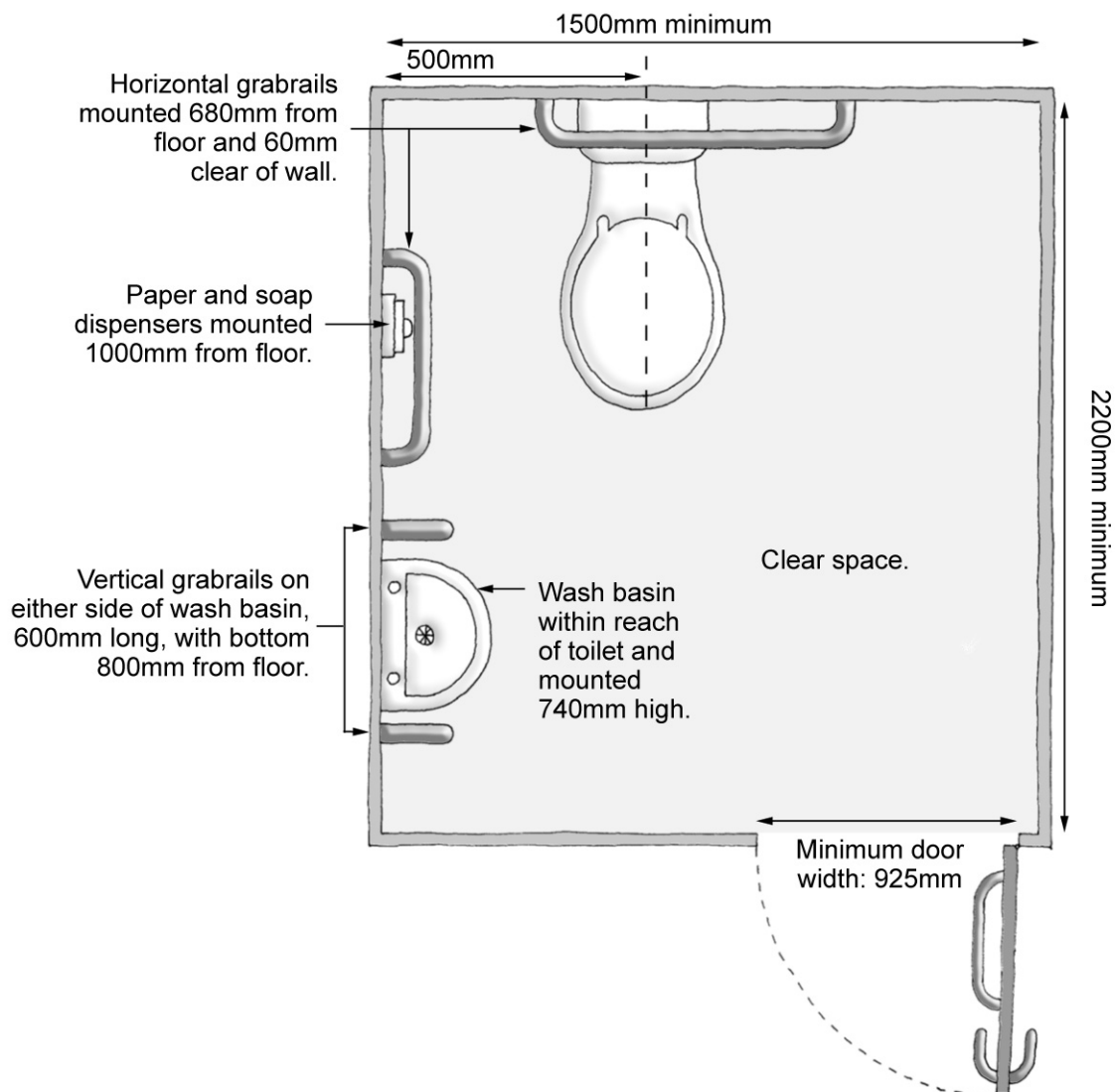

**Figure 3.61** Typical assistance booth at railway station in Mumbai, India

The buttons and slots on ***automatic ticket machines*** should be no more than 1200mm from the ground so they can be used by wheelchair users and people of short stature.

***Ticket gates*** or turnstiles controlling the entrance to the station or to platforms are difficult or impossible to use for many people including disabled people. There should be a 900mm wide accessible route, clearly marked, through the ticket gates and collection area.

If **toilets** are available for non-disabled people, they should also be available for disabled people. Accessible toilets that are marked as 'unisex' are better than separate male and female toilets, as it can be used by the many disabled people who are accompanied by an attendant or companion of the opposite sex. When designing the layout of toilets, it is most important to provide enough clear space for people using wheelchairs and other equipment to enter and manoeuvre; to put amenities at a reachable height; to provide sufficient handrails to assist people transferring from a wheelchair or people with reduced strength; and to provide easy-to-operate amenities such as taps and door handles for people with reduced hand dexterity. Door handles should be large and easy to grasp (see Figure 3.55). Many countries have their own standards for accessible toilets. Figure 3.62 summarises some best practice recommendations.



**Figure 3.62** Dimensions and amenities for a typical wheelchair accessible toilet (Based on Oxley, 2002)

## **Where to start?**

It is accepted that it is much easier – and, very importantly, cheaper – to achieve full access from the design and construction stage, rather than by trying to modify a building at a later stage.

When existing stations have to be retrofitted with access features, major stations with high passenger flows, stations in accessible networks, and stations serving major destinations in the city are a good starting point as this may benefit most passengers. When existing stations are upgraded or maintained the opportunity should also be taken to start making incremental improvements to serve passengers better with a variety of needs.

## **Further references**

- Access Board (2002). Americans with Disabilities Act Accessibility Guidelines for Buildings and Facilities (ADAAG). (Retrieved: 2003, from [www.access-board.gov/adaag/html/adaag.htm](http://www.access-board.gov/adaag/html/adaag.htm))
- British Standards Institute (2001). Design of buildings and their approaches to meet the needs of disabled people – code of practice. BS 8300:2001. London: British Standards Institute.
- COST (1999). Passengers accessibility of heavy rail systems. Final report. COST 335. (Retrieved: 2003, from [www.cordis.lu/cost-transport/src/cost-335.htm](http://www.cordis.lu/cost-transport/src/cost-335.htm))
- European Committee for Standardisation (CEN) (2000). Safety rules for the construction and installation of lifts – Part 70: Particular applications for passenger and goods passenger lifts – Accessibility to lifts for persons including persons with disability. Draft European Standard. Brussels: CEN.
- European Conference of Ministers of Transport (1999). Improving transport for people with mobility handicaps: a guide to good practice. Paris: OECD.
- Oxley P (2002). Inclusive mobility – a guide to best practice on access to pedestrian and transport infrastructure. London: Department for Transport. (Retrieved: 2003, from [www.dft.gov.uk](http://www.dft.gov.uk))
- Strategic Rail Authority (2002). Train and station services for disabled passengers: a code of practice. London: Strategic Rail Authority.
- UNESCAP (United Nations Economic and Social Commission for Asia and the Pacific) (1995). Promotion of non-handicapping physical environments for disabled persons: guidelines. New York: United Nations.

## 13 Car parking

---

*In developing countries relatively few people with disabilities can afford private cars. Yet, as car ownership increases, it is good practice to start providing accessible parking in key locations. Accessible parking spots/spaces can also be useful for disabled users of metered taxis or specialised door-to-door services.*

### Basic principles

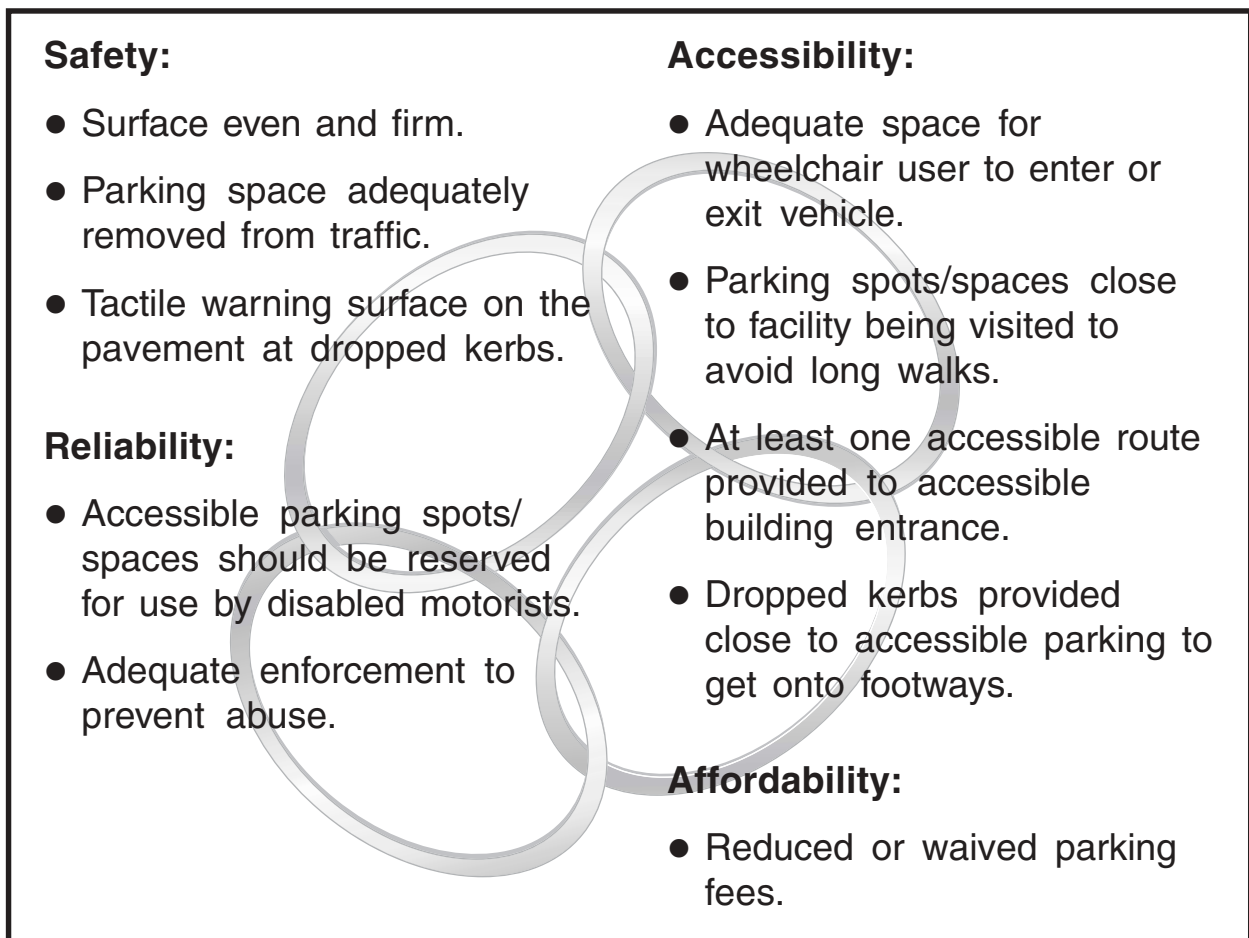

### Good practices

#### *Number and location of parking spaces*

In off-street car parks, it is usual practice to designate the parking spaces closest to the facility's entrance for disabled drivers. In the UK, where the number of disabled drivers is relatively high guidelines typically require that between 2% and 6% of parking spaces be designed and reserved for disabled users (see Table 3.7), with a minimum of one space. This is in addition to spaces for disabled employees who are motorists.

**Table 3.7 UK guidelines for number of accessible parking spaces**

<i>Proportion accessible parking spaces</i>	<i>Application</i>
2% of all spaces (plus for disabled employees)	Existing employment centres.
5% of all spaces (including for disabled employees)	New employment centres.
6% of all spaces (plus for disabled employees) minimum of one space	Shopping, leisure, public spaces all car parks.

*Source: Oxley, 2002*

### *Layout*

The recommended layout and dimensions of parking spaces and clear spaces around them are shown in Figure 3.63. It is recommended that parking bays should be sited where the road gradient is reasonably level, as steep gradients cause difficulties for wheelchair users with a side lift in their vehicle. The accessible parking space(s) should connect to an accessible footway or route that connects to an accessible entrance to the building. The route should not require wheelchair users to pass behind vehicles that may be backing out.

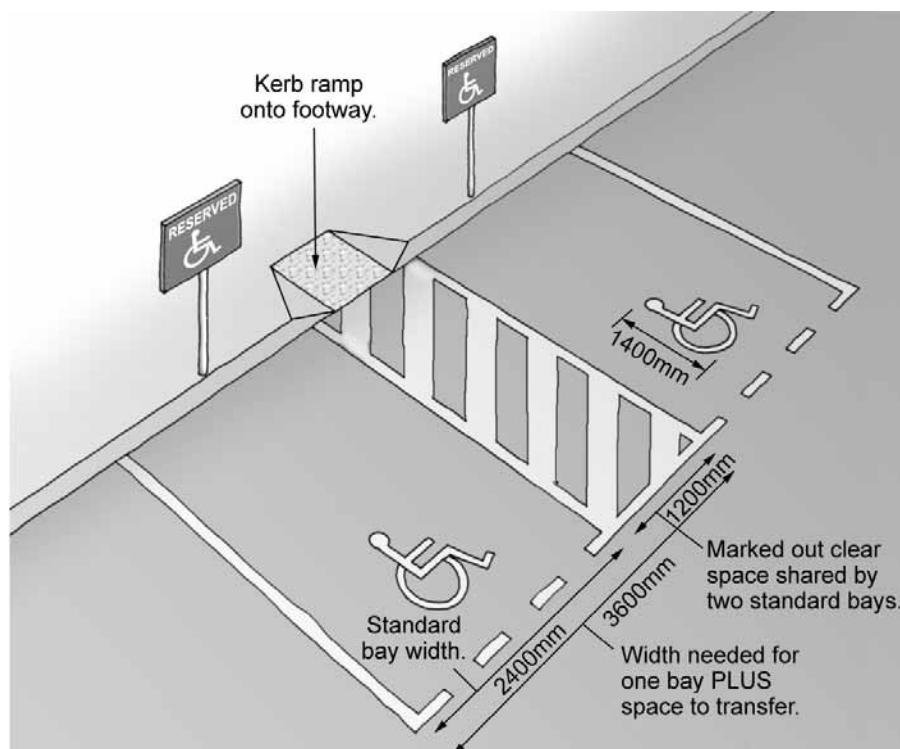

**Figure 3.63** Recommended dimensions on parking spaces (*Based on Oxley, 2002*)

Parking spaces that are 3.6m wide compared to standard width of 2.4m allows a user to transfer from their chair into the car. Where there are several bays together some space can be saved by having one shared space (1.2m) between two bays.

### *Enforcement*

Designated parking spaces should be clearly marked with the international disability symbol. Many countries impose a fine if these spaces are abused. Adequate law enforcement is necessary to prevent abuse.

### **Where to start?**

Ideally, provision should be made for disabled motorists wherever conventional parking spaces are provided. However key locations such as shopping or business districts, medical facilities, and government offices could be prioritised first. In addition, employers could be encouraged to provide designated parking for every disabled employee who needs one.

### **Further references**

- Access Board (2002). Americans with Disabilities Act Accessibility Guidelines for Buildings and Facilities (ADAAG). (Retrieved: 2003, from [www.access-board.gov/adaag/html/adaag.htm](http://www.access-board.gov/adaag/html/adaag.htm))
- British Standards Institute (2001). Design of buildings and their approaches to meet the needs of disabled people – code of practice. BS 8300:2001. London: British Standards Institute
- Department for Transport, Local Government and the Regions (1995). Parking for disabled people. Traffic Advisory Leaflet 5/95. DTLR: London. (Retrieved: 2003, from [www.dft.gov.uk](http://www.dft.gov.uk))
- European Conference of Ministers of Transport (1999). Improving transport for people with mobility handicaps: a guide to good practice. Paris: OECD.
- Oxley P (2002). Inclusive mobility – a guide to best practice on access to pedestrian and transport infrastructure. London: Department for Transport. (Retrieved: 2003, from [www.dft.gov.uk](http://www.dft.gov.uk))
- UNESCAP (United Nations Economic and Social Commission for Asia and the Pacific) (1995). Promotion of non-handicapping physical environments for disabled persons: guidelines. Annex 2. New York: United Nations

## 14 Signage and travel information

---

*Signage and information is important for all passengers to know when to catch public transport, how much the fare is, and where to find a specific train, bus or minibus within a station or rank.*

*Adequate information – and especially real-time information that reflects changes as they happen – helps not only regular passengers when circumstances change, but can also help attract occasional users and tourists – which is a growing market in developing countries. For people with disabilities, having access to information in usable formats is particularly important, to help avoid unnecessary effort and to help plan their journey with confidence. For people with visual, hearing or mental impairments, having access to information may be the defining need that allows them to travel independently.*

*This section deals with information in all formats: signage used in terminals, stations and on-board vehicles; printed leaflets and timetables; and audible announcements. It concentrates on good practice regarding format; for guidance on the content of signs and messages refer to the relevant section where it is to be used.*

## Basic principles

### Safety:

- Information signs and boards posted close to but not obstructing passenger circulation areas.

### Reliability:

- Information on times, services and fares should be accurate and updated timely to reflect changes.
- Emergency information provided in audible and visual formats.

### Accessibility:

- Visual information provided in correct size, colour, format to be easily legible by all passengers including those with low vision.

- Adequate lighting to ensure legibility at night.

- Key information provided in tactile format where possible.

- Visual information should be simple and concise, using symbols where possible, to be easily understood by all passengers including visitors, illiterate and learning impaired people.

- Clear audible information provided to assist visually impaired and hard of hearing people.

### Affordability:

- Information (printed and telephone) available at no or low cost.

## Good practices

### *Size and format of signage*

The minimum size of letters and symbols depends on the distance from which it is read and the degree of visual impairment of the reader. Various studies have produced a range of preferred sizes. In the Netherlands, for instance, it is recommended that the letter size should be 1% of the distance from which the sign is read (*Ministerie van Verkeer en Waterstaat, 2000*). Typical minimum letter sizes for different applications are shown in Table 3.8. Best typefaces to use for signs and information are sans serif (such as Helvetica or Standard), with a width to height ratio of between 3:5 and 1:1. Lower case letters are much easier to read than UPPERCASE (capital) letters.

Symbols can help significantly to convey a 'snapshot' of information, especially to passengers seeing a sign from a moving vehicle. However it

**Table 3.8 Recommended letter sizes and applications for signage**

<i>Minimum letter height</i>	<i>Application</i>
200mm	Route number shown on buses and trains.
150mm	Long distance reading e.g. signs on building entrances.
125mm	Route name/destination on buses and trains.
50-100mm	Indoor use e.g. signs in corridors and stations.
50mm	Information on bus stop flags and shelters.
15-25mm	Close reading e.g. wall-mounted timetables.

*Source: Based on various guidelines*

is important for signage to be unambiguous and to be used consistently, to avoid confusion. The international symbol for access (shown in Box 3.9) should be used to identify accessible entrances, routes or facilities within a building, or transport services that are *fully* (wheelchair) accessible only. Regarding the sizes of symbols, the letter heights of Table 3.8 can be approximately doubled to ensure adequate visibility of symbols.

#### *Placement of signs*

Wall-mounted signs should be placed at a consistent height of between 1300mm and 1600mm above floor level to be at an optimum viewing angle. Signs that should not be obscured by other people (such as directional or emergency signs) should be higher than 2000mm, or 2100mm if they are suspended overhead. In large areas like station halls they will of course be higher than this to be visible from a longer distance.

#### **Box 3.9 International symbol of access**



The international symbol of access is used all over the world to direct people with various disabilities towards accessible features and facilities. The symbol should be used in the proportions shown in the figure, and preferably be 100mm by 100mm large. The colour should be white on a blue background, and the symbolised figure should be facing to the right.

### Colour contrast

It is essential that letters and symbols on a sign should contrast with the background of the sign. In general, dark text on a light background is preferable, except for signs that are lit from inside where light letters show up more clearly. The signboard itself should again contrast with its surroundings (Figure 3.64). Table 3.9 shows colours that contrast well. Good lighting and a matt finish (instead of a glossy, shiny finish) will also enhance readability.



**Figure 3.64** Good colour contrast greatly enhances the readability of signage

**Table 3.9** Colour contrast for signs

<i>Background</i>	<i>Sign board colour</i>	<i>Letter/symbol colour</i>
Red brick or dark stone.	White.	Black, dark green or dark blue.
Light brick or light stone or whitewashed walls.	Black/dark.	White or yellow.
Green vegetation.	White.	Black, dark green or dark blue.
Back-lit sign.	Black.	White or yellow.

*Source: Merseyside code of practice, in Oxley (2002)*

### *Tactile signage*

Tactile signage can be used effectively to provide key information to visually impaired passengers such as route numbers or the direction to ticket counters, bus bays or railway platforms. The letters, numbers or pictograms should be fixed against the wall or bus stop pole at a height of 1 metre from the ground. Characters should be raised about 1mm to 1.5mm from the surface, at least 15mm high, and painted to contrast with the surface. Most blind and visually impaired people do not read Braille, so embossed signs will generally be more useful.

### *Printed material*

Printed material containing information on bus, train or taxi services; specific services and features for disabled people; or timetables and fares should be legible to people with low vision. The use of larger typefaces implies a trade-off with the amount of information provided. Usually this is a good thing, as simple and clear material with less information is often more user-friendly to everybody than volumes of comprehensive but incomprehensible data.

In general the above guidelines with respect to typeface, colour and format also apply to printed matter. UK and European guidelines recommend a minimum letter size of 14 point for timetables and for large-print material. European good practice states that timetables and brochures should in fact be printed in large print (see *ECMT, 1999*).



**Figure 3.65** Large-print brochures from the UK

Grey shading and red or green ink should be avoided – black ink on white paper is the most legible combination. Printed material should always include a telephone number where more information can be obtained.

### *Audible information*

Audible announcements are helpful to most people but particularly to people with visual impairments. Public announcement (PA) systems in stations or terminals should be clear and loud enough to be understood by people with hearing impairments, who typically require announcements to be at least 5 dB above the ambient noise levels. Inside public transport vehicles, the use of a PA system is recommended in large vehicles for announcements about major stops to be heard. However this may often not be affordable, or indeed necessary if smaller vehicles (up to about 30 seaters) are used. In such cases the driver or conductor should announce information at least loud enough to be heard by passengers in the priority seating area. Some telephone information services include a Telecommunications Device for the Deaf (TDD), while text phones are useful for people who are profoundly or severely deaf.

### *Emergency information*

Exit routes from buildings or vehicles in case of an emergency should be clearly signed. To serve both visually and hearing impaired people, emergency alarms should have both audible and visual features, such as an alarm sound coupled with a flashing warning light.

## **Where to start?**

All new signage in newly constructed transport facilities (stations, ranks, stops) should follow good practice guidelines. The refurbishment or maintenance of existing facilities also presents good opportunities to improve the quality of signage and information. Printed leaflets and timetables are very useful for people with disabilities to plan their trip beforehand, but only if the information is accurate and up-to-date. Initially it may be reasonable to concentrate on printing timetables in larger print and audio information (on tape or telephone), only for major routes and routes that are being made more accessible to people with disabilities.

## **Further references**

- Access Board (2002). Americans with Disabilities Act Accessibility Guidelines for Buildings and Facilities (ADAAG). (Retrieved: 2003, from [www.access-board.gov/adaag/html/adaag.htm](http://www.access-board.gov/adaag/html/adaag.htm))

- Barker P and Fraser J (2000). Sign design guide. Joint Mobility Unit and the Sign Design Society. RNIB: London.
- COST (1999). Passengers accessibility of heavy rail systems. Final report. COST 335. (Retrieved: 2003, from [www.cordis.lu/cost-transport/src/cost-335.htm](http://www.cordis.lu/cost-transport/src/cost-335.htm))
- Disabled Persons Transport Advisory Committee (1996). Legibility of bus timetable books and leaflets – code of good practice. London: DPTAC. (Retrieved: 2003, from [www.dptac.gov.uk](http://www.dptac.gov.uk))
- European Conference of Ministers of Transport (1999). Improving transport for people with mobility handicaps: a guide to good practice. Paris: OECD.
- Ministerie van Verkeer en Waterstaat (2000). Reisinformatie – bruikbaar voor iedereen. Den Haag, The Netherlands.
- Oxley P (2002). Inclusive mobility – a guide to best practice on access to pedestrian and transport infrastructure. London: Department for Transport. (Retrieved: 2003, from [www.dft.gov.uk](http://www.dft.gov.uk))

## 15 Specialised transport services

---

*Specialised services refer to transport services that are specifically tailored to the needs of passengers with disabilities. Specialised services usually use vehicles that provide full access to wheelchair users through mechanical lifts or ramps, but differ from regular public transport in the way they are operated. Service models range from door-to-door services that exclusively serve disabled people, to 'service routes' which also serve the general public but are specifically routed to travel close to the origins and destinations of elderly and disabled people. Accessible (metered) taxis, although not a specialised service, are also used to provide kerb-to-kerb services for disabled people. The use of specialised transport services acknowledges that regular public transport cannot serve the needs of all disabled people: for example, many are simply unable to walk to, board, or travel independently in public transport vehicles due to the severity of their impairments. Although specialised transport services are usually more expensive to provide (on a per passenger basis) than accessible regular public transport, such services are funded with public funds in several cities of the developing world, including Sao Paulo, Brazil, Cape Town, South Africa, Kuala Lumpur, Malaysia (door-to-door services) and Puebla, Mexico (service routes).*

*This section does not deal primarily with the design of vehicles used in specialised services, as the same good practice discussed in Sections 9 to 11 apply. The emphasis in this section is more on the operation and planning of specialised services.*

## Basic principles

### **Safety:**

- Vehicle design and features are safe to avoid injury.
- Lifting equipment and ramps designed and operated safely to avoid injury.
- Vehicles driven smoothly and considerately.

### **Reliability:**

- All advertised accessibility features available and working.
- Driver/staff provide helpful service and special assistance where needed.

### **Accessibility:**

- Easy and unhindered boarding via steps (if any).

- Level boarding for wheelchair users into vehicle.
- Hand grips and steps highly visible.
- Easy stowage of mobility aids (wheelchairs, guide dogs, walkers).
- Signage identifying vehicles and specialised service.
- Call-in telephone service for reservations or queries (if any) with text telephone / TDD
- Alternatives to telephonic booking for non-telephone owners.

### **Affordability:**

- Affordable fare for targeted passengers with disabilities.

## Good practices

### ***Door-to-door services***

#### *Choice of vehicle*

Current door-to-door services typically use small vehicles (mini or midibuses) as they are cheaper to operate (especially if a ramp can be used for wheelchair access rather than mechanical lift). Small buses may also be better able to negotiate narrow lanes and poorly maintained roads in residential areas where regular public transport vehicles do not operate. In some parts of the world volunteer drivers carry disabled passengers in their own car. Such services can be very useful in low density areas where conventional public transport is scarce, but since regular private vehicles are used they can only serve ambulatory passengers and wheelchair users who are able to transfer to a car seat.

### Box 3.10 Door-to-door services in São Paulo, Brazil

São Paulo Transport operates a free door-to-door service using 265 lift-equipped vans for poor people who are certified with severe mobility problems. The system is oriented towards independent living, with many allowable trip purposes within an overall focus on trips to rehabilitation centres, schools and hospitals. The service pursues efficiency by limiting trips to within each of the nine large districts which divide up the city. Feeder services to accessible bus lines provides service between districts.

São Paulo's door-to-door services are financed by monthly payments from the concessioned fixed-route bus operators, with quotas based on the number and kilometres of their vehicles. Van drivers are selected by the various bus operators and then must complete training sessions focused on (1) relations with passengers with disabilities, (2) driver training, (3) different types of disability, (4) regulations and management governing the service, and (5) mechanics of vehicles.



Figure 3.66 São Paulo's door-to-door service is one of the largest in the developing world

#### Choice of operator

Many door-to-door services in the US are contracted out to private operators, many of whom are taxi companies using regular taxis and wheelchair accessible taxis or vans to provide the service in urban areas. Contracting out of the service typically results in lower costs to the subsidising agency, as taxi operators frequently achieve very low profit margins but none the less provide an efficient service (TRB, 1998a). The use of taxis especially in urban areas takes advantage of the inherent efficiency of the taxi system in high demand areas using vehicles with lower capital costs and operating costs than other vehicle types that could provide such a service.

### *Trip reservation*

Reservations for door-to-door service are typically made by telephone, between two days and a few hours in advance of the trip. This gives the operator enough time to assign each trip to a vehicle. Telephone reservation does however, require passengers to have access to a telephone; if access is a concern it becomes more important to work with social service organisations and social workers in the area to ensure reservations can be made through alternative means.

### *Eligibility*

Passengers are usually required to pre-register for using door-to-door services, in order to make sure that only eligible people use it. Best practice in eligibility certification uses face-to-face contact with potential users to determine if they are eligible for specialised services (for instance if they are functionally unable to use regular public transport) (TRB, 1998b). This is considered a better approach than simply screening people on the basis of the type of their disability.

### *Vehicle scheduling*

Thought needs to be given to good scheduling of vehicles, to ensure vehicles carry as many passengers as possible on each trip, without making passengers wait too long. If stops are 'clustered' in the same neighbourhood or corridor rather than scattered over a large area, more passengers will be carried at a lower cost per trip, making the service more cost effective. Although software is available for automating the scheduling exercise, simple manual scheduling techniques undertaken by a person well familiar with the area, have been shown to be adequate for systems with less than about 25 vehicles.

## **Service routes**

### *Choice of vehicle*

Service routes are usually operated by medium or full-size vehicles with higher capacities than door-to-door services. Vehicles are fully accessible, preferably low-floor or with ramps or lifts.

### *Route planning and schedule*

Service routes operate along fixed routes which are specifically chosen to connect origins and destinations frequently used by older and disabled passengers. Thus routes may run past retirement homes, home-care facilities, medical facilities, social service facilities, and shopping areas. It thus maximises access to various destinations while minimising walking distances; typically, this comes at the cost of increased travel time as routes are more circuitous.

Service routes also often have more flexible pick-up/alighting points, including stop-on-demand (instead of only at designated bus stops) and possible route deviation. With route deviation services it is possible to deviate slightly from the core route on request. The timetable usually allows more time at stops than on conventional services. Both service routes and door-to-door services can be used to provide a feeder service to accessible bus routes or railroad stations.



**Figure 3.67** A service route bus in South Africa loading passengers at their place of work

### ***General***

#### *Fares*

Door-to-door services typically charge between one and two times the fare for an equivalent trip by public transport. As with other accessible services, specialised services should be priced to ensure that disabled people – many of whom have very low incomes – can afford to use them. However, this often requires higher subsidies from government, as the services are more expensive to provide than general use-services. The eligibility process can be used to ensure that subsidies are targeted at those who really need them because they cannot access any other transport services.

#### *Operating rules*

Restricted capacity usually forces service routes and dial-a-ride services to limit eligibility for the service to people with disabilities. However, if extra capacity exists the service can be marketed to other potential

passengers in order to become more cost effective whilst providing a service in an increasingly integrated setting. A premium fare could be charged to non disabled passengers to increase revenues and ensure the sustainability of the service.

### *Training*

Drivers and assistants of door-to-door services and service routes should be trained to provide a high quality service to disabled passengers. Assistance should be given boarding and alighting and in ensuring wheelchairs are secure and that their occupants are safe to travel.

### **Where to start?**

Providing subsidised door-to-door services should be considered if funding can be raised. Specialised services for disabled people is the most common first step to serve people who are excluded from using other forms of transport, especially wheelchair users who do not have access to private vehicles. Door-to-door services can often be initiated more quickly than upgraded bus and rail services. Door-to-door services do not rely as much on accessible footways and other infrastructure as do bus and rail services. One approach that has been used successfully in demonstration projects such as in Cape Town, is to initially limit the areas served by door-to-door services so that vehicles do not have to cover a large part of the city. Productivity can also be enhanced by choosing areas with higher concentrations of persons who are likely to require the service.

Service routes are also more expensive than regular bus and rail transport, although productivity may be higher than with door-to-door services. Yet this may be an approach particularly suited as an interim solution in developing countries where accessibility of the mainstream public transport system is poor. Targeting of initial funding at carefully designed service routes may ensure it is spent where it can best be used in terms of actually transporting passengers who cannot use other modes. It is necessary however to go beyond this and invest in upgrading the rest of the transport system, as in the long run this will serve the most (disabled and other) passengers at minimum cost. (See Part 2 of this guide for more information on the potential role of service routes in an incremental accessibility strategy.)

Service routes can be initiated inexpensively by using existing buses retrofitted with wheelchair access equipment and other accessibility features.

## Further references

- Disabled Persons Transport Advisory Committee (DPTAC) (December 2003). Making private hire services more accessible to disabled people: a good practice guide for Private Hire Vehicle operators and drivers. London: DPTAC. (Retrieved: 2003, from [www.dptac.gov.uk](http://www.dptac.gov.uk))
- European Conference of Ministers of Transport (1999). Improving transport for people with mobility handicaps: a guide to good practice. Paris: OECD.
- Sohail M, Mitlin D and Maunder D A C (2003). Partnerships to improve access and quality of public transport. Guidelines. Loughborough: WEDC, Loughborough University.
- Thatcher R H, Gaffney J K (1991). ADA Paratransit Handbook: Implementing the complementary paratransit service requirements of the Americans with Disabilities Act of 1990. Washington DC: USDOT.
- Transportation Research Board (1998a). Paratransit contracting and service delivery methods. TCRP Synthesis of Transit Practice 31, Washington DC. (Retrieved: 2003, from <http://www.trb.org/>)
- Transportation Research Board (1998b). ADA Paratransit Eligibility Certification Practices. TCRP Synthesis of Transit Practice 30, Washington DC. (Retrieved: 2003, from <http://www.trb.org/>)

## 16 Training

---

*Wherever public transport services have become increasingly more user-friendly towards people with disabilities, the training of staff, managers and officials has been an important element. In many developing and transition countries, this is particularly important as managers, drivers and conductors often do not have a service ethos towards their passengers, let alone sensitivity towards passengers with special needs. Disabled passengers consistently identify attitudinal barriers and ignorance as a major barrier restricting them from using public transport. Part of the objective of improving public transport access will thus be achieved only if governments, users, and operators partner in creating a more customer-oriented culture in public transport. But experience has also shown that the needs of people with disabilities can better be served if staff are not only courteous and helpful, but are also equipped with specific knowledge on how to serve people with specific needs. Well trained staff are also important to retaining existing passengers and attracting new passengers to public transport by improving the quality of the service.*

*Another aspect of training relates to the training of deaf/blind people and those with learning disabilities on how to use the public transport system. This so-called 'travel training' can help some disabled people – particularly those with visual or cognitive impairments – to be able to travel without assistants, thus enhancing their independence.*

## Basic principles

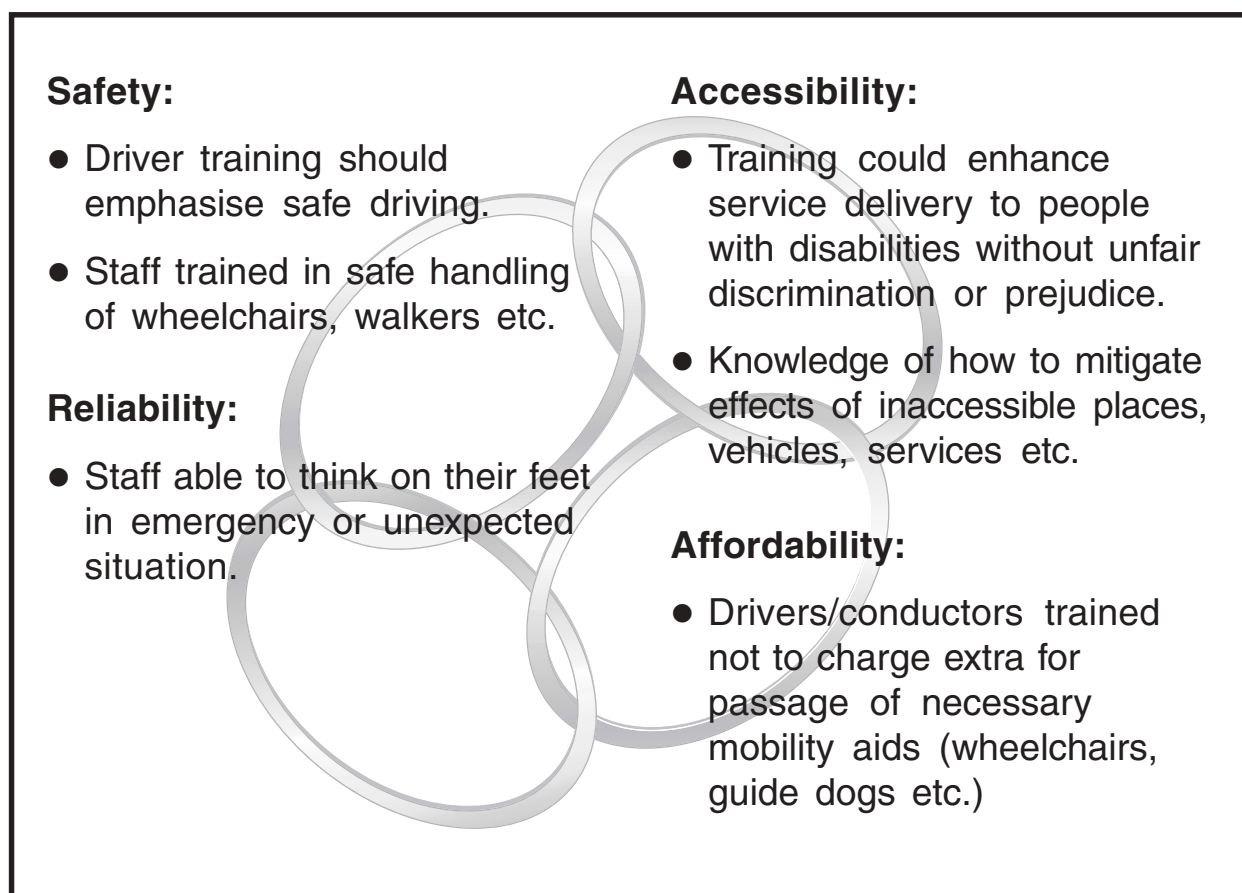

## Good practices

### *Training courses*

Training courses in disability awareness have been developed in many countries across the world, including some developing countries (see Box 3.11). The United Kingdom's DPTAC suggest the following elements should be included in courses: (*DPTAC, 2000*):

- Barriers faced by disabled people, covering attitude, environment and organisation.
- Principles of access audits: how to identify accessibility and inaccessibility.
- Information on all disabilities, including hidden disabilities.
- Suggestions for removing barriers faced by disabled people (including changed driving behaviour to improve safety for disabled passengers), and the skills needed for serving disabled travellers (for instance, how to 'push' and 'brake' a manual wheelchair).

- Communication and interpersonal skills for communicating with disabled people, particularly those with a hearing impairment or with learning disabilities (including etiquette and language – (see Part 2 for some pointers).
- Enabling staff to deal with unexpected occurrences – to ‘think on their feet’ when a problem arises (this could include basic first aid training if needed).

**Box 3.11 Disability awareness training of bus and taxi drivers in Mexico City**

The Federal District of Mexico City partners with the private sector to include disability awareness training in weekend driver instruction programmes for bus and taxi drivers. This training is a requirement for the issuing of a license to any of the 180,000 drivers. As of March 2002, the training includes 10 hours of instruction on relating to passengers who are disabled, older, women, or young people, using materials prepared by the government social service agency.

Part 2 briefly described the Social Model of Disability, which views disability as a concept imposed by society on people with impairments. Disability awareness training should be based on this concept, in order to help transport staff to view their jobs in terms of promoting equality, rather than undertaking welfare work. It is usually very useful to involve disabled people’s organisations directly in the training, for instance by inviting representatives to present some or all of the topics mentioned above. Furthermore, it is very important to expose not just front-line staff (such as drivers and ticket collectors) to disability awareness training, but also those who design, plan and manage transport systems, as it is managers who help set the ethos of the organisation and who drive decisions regarding access improvements.

One way of exposing non-disabled staff to the issues faced by disabled people when travelling is to engage them in simulation exercises. Disability simulation exercises could consist of putting participants in wheelchairs or blindfolding them. However care needs to be taken to choose such a situation and time that is acceptable to all participants.

*Training of users*

In many cases orientation, also called ‘travel training’, can be offered to assist new passengers who have never travelled by public transport before. Training may be especially important to people with learning



**Figure 3.68** Wheelchair user Anjee Agarwal briefs auto-rickshaw drivers about the access needs of wheelchair users during disability awareness training workshops in Delhi, India. About 350 drivers were trained in late 2003 as part of the Badge Training of the drivers in the State Transport Authority (STA) office. *(Photograph: courtesy of Samarthya, Centre for Promotion of Barrier Free Environment for Disabled Persons, India)*

disabilities such as Down's Syndrome, many of whom can independently use public transport if it is reliable and predictable. Public transport operators can work effectively with disabled persons' organisations and social workers to promote travel training. It is beneficial to include road safety education in travel training to teach people safe places to cross.

### **Where to start**

Many formalised public transport operators (bus and rail) routinely train their staff in safety and operational aspects of the service. Modules on disability awareness can easily be incorporated into these programmes, especially for new recruits. The costs of developing and delivering the training can be kept low by involving disabled persons' organisations in the process – this will also enhance the value of the training to both parties.

A training video can be made relatively easily and used on a continuing basis to train staff.

Helpful videos and other training materials can be shared between transport stakeholders in different countries.

## Further references

- COST (1999). Passengers accessibility of heavy rail systems. Final report. COST 335. (Retrieved: 2003, from [www.cordis.lu/cost-transport/src/cost-335.htm](http://www.cordis.lu/cost-transport/src/cost-335.htm))
- Disabled Persons Transport Advisory Committee (1996). Take care of your customers. Leaflet. DPTAC: London. (Retrieved: 2003, from [www.dptac.gov.uk](http://www.dptac.gov.uk))
- Disabled Persons Transport Advisory Committee (September 2000). Advice for taxi drivers. Leaflet. DPTAC: London. (Retrieved: 2003, from [www.dptac.gov.uk](http://www.dptac.gov.uk))
- Disabled Persons Transport Advisory committee (DPTAC). (December 2003). Making private hire services more accessible to disabled people: a good practice guide for Private Hire Vehicle operators and drivers. London: DPTAC. (Retrieved: 2003, from [www.dptac.gov.uk](http://www.dptac.gov.uk))
- Sohail M, Mitlin D and Maunder D A C (2003). Partnerships to improve access and quality of public transport. Guidelines. Loughborough: WEDC, Loughborough University.

## Appendix A: Norms and guidelines for selected infrastructure and vehicle access features

### Norms and guidelines for selected infrastructure and vehicle access features (in millimetres)

<i>Status</i>	<i>Wheelchair footprint Length Width</i>	<i>Min. exterior ped. path width</i>	<i>Min. clearance over ped. path</i>	<i>Max. ramp incline (8 metre ramp)</i>	<i>Max. curb ramp incline</i>	<i>Min. door clearance</i>	<i>Min. auto parking space +aisle width</i>	<i>Max. height to 1<sup>st</sup> vehicle step</i>	<i>Max. ground to veh. floor height</i>	<i>Hand grasp both sides veh. door?</i>	<i>Min. letter height as % of distance</i>	<i>Signage colour contrast req'd?</i>	<i>Min. bus stop space Length Width</i>
<b>Peru</b>													
Guidelines published by NGO	1250 L 750 W	900 - 1500	2100	1:12	1:10	800	3970						
<b>Ecuador</b>													
Norms published by Gov't agency		1600	2050	1:10 – 1:12	1:8 – 1:10	900	3500				Yes	Yes	1800 L x 1800 W
<b>Costa Rica</b>													
Law published by Gov't agency	1300 L 800 W <i>min. space</i>	1200 (1800 for 2 wheel- chairs)	2200	10%	8.5%	900	3300	Tentatively 300-350 (under review)	No spec.	Yes	Yes	Yes	Under review
<b>Argentina</b>													
Law published by Gov't agency	1200L 700W	1500	2000	1:16 outdoors 1:12.5 indoors	1:12 (Buenos Aires) 1:10 (nat'l)	800	3500		400 (for low- floor buses)	No	No	Yes	No

Continued....

**(Continued) Norms and guidelines for selected infrastructure and vehicle access features (in millimetres)**

<i>Status</i>	<i>Wheelchair footprint Length Width</i>	<i>Min. exterior ped. path width</i>	<i>Min. clearance over ped. path</i>	<i>Max. ramp incline (8 metre ramp)</i>	<i>Max. curb ramp incline</i>	<i>Min. door clearance</i>	<i>Min. auto parking space +aisle width</i>	<i>Max. height to 1<sup>st</sup> vehicle step</i>	<i>Max. ground to veh. floor height</i>	<i>Hand grasp both sides veh. door?</i>	<i>Min. letter height as % of distance</i>	<i>Signage colour contrast req'd?</i>	<i>Min. bus stop space Length Width</i>
<b>El Salvador</b>													
National technical norms		1200	2200	8%	10%	1000	3500				Yes	Yes	
<b>Mexico</b>													
Mexico City Gov't guidelines	1220-1370 L 610-660 W	1200-1500	2000	1:12	6-10% per length	1000	3800	400	960 (artic)		NA	Yes	NA
<b>Asia-Pacific regional UN agency</b>													
Guidelines	1200 L 750 W	900-1500	2000	1:16	1:12	750-900	3600					Yes	
<b>Malaysia</b>													
Guidelines published by an NGO	1200 L 750 W	1500 (2 wheel chairs to pass)	2000	1:15 outdoors 1:12 indoors	1:8-1:12	900	3600					Yes	1980 L x 2100 W
<b>Australia</b>													
National law	1300 L 800 W space	1200 (1800 to pass)	NA	1:12	1:8	800	NA					Yes	

**(Continued) Norms and guidelines for selected infrastructure and vehicle access features (in millimetres)**

<i>Status</i>	<i>Wheelchair footprint Length Width</i>	<i>Min. exterior ped. path width</i>	<i>Min. clearance over ped. path</i>	<i>Max. ramp incline (8 metre ramp)</i>	<i>Max. curb ramp incline</i>	<i>Min. door clearance</i>	<i>Min. auto parking space +aisle width</i>	<i>Max. height to 1<sup>st</sup> vehicle step</i>	<i>Max. ground to veh. floor height</i>	<i>Hand grasp both sides veh. door?</i>	<i>Min. letter height as % of distance</i>	<i>Signage colour contrast req'd?</i>	<i>Min. bus stop space Length Width</i>
<b>Russia</b>													
Guidelines issued by city agency		1200	1980	1:12	1:10-1:12	810-915	3970						1980 L x 2100W
<b>Canada</b>													
National guidelines	NA	1500	1980-2030	1:12	NA	810	3900			Yes	Yes	Yes	2100W
<b>UK</b>													
National regulations and guidelines	1200 L 700 W	1500	2100-2300	1:20	1:12	900	3600	250	750	Yes	Yes	Yes	3000 L x 2000W

*The information is obtained from a variety of guidelines, norms and standards published in various countries as indicated. The status of the information varies from recommended practice to mandatory standards, and actual experience with the application of norms varies across countries.*

*The establishment of norms or guidelines for access is a dynamic process; several of the elements shown here are currently under review and may change (or have changed prior to publication).*

## Appendix B: Further resources

---

### **Enhanced accessibility for people with disabilities living in urban areas (R8016)**

*These guidelines have been produced as part of a project funded by the UK Department for International Development (DFID). Details of the project and background documents can be downloaded from the project's webpage found at [www.transport-links.org](http://www.transport-links.org).*

The publications include:

**Venter C J, Maunder D, Stone J, Venkatesh A, deDeus K and Munthali D. (2004).** *Practical solutions for transport access of urban residents with disabilities.* Paper presented at CODATU XI, April 2004. Bucharest, Romania.

**Maunder D, Venter C J, Rickert T and Sentinella J (2004).** *Improving transport access and mobility for people with disabilities.* Paper presented at CILT Regional Conference, March 2004. Dubai, UAE.

**Savill T, Stone J, Venter C J and Maunder D (2003).** Improving access to transport in developing countries. *Municipal Engineer*, 156, 2, pp 149-153

**Venter C J, Rickert T and Maunder D (2003).** *From basic rights to full access.* Paper presented at TRB Annual Conference, January 2003, Washington, USA.

**Venter C J, Bogopane H, Rickert T, Camba J, Venkatesh A, Mulikita N, Maunder D and Savill T (2002).** *Improving accessibility for people with disabilities in urban areas.* Proceedings: CODATU X. Lome, November 2002. Togo.

**Venter C J, Savill T, Rickert T, Bogopane H, Venkatesh A, Camba J, Mulikita N, Stone J and Maunder D (2002).** *Enhanced accessibility for people with disabilities living in urban areas.* Project Report PR/INT/248/02, Crowthorne: TRL Limited. (*Unpublished report available on direct personal application only*)

### ***Other publications and web links***

During the past few years there has been a marked increase in resources available to assist stakeholders to advocate, plan, and implement accessible transportation around the world. The following selected web sites are annotated with key publications which focus on accessible transport. An \* means the entire publication is available at the site, while other publications can be ordered. These sites usually contain many additional features of interest. This is not a complete list.

## Advocacy

[www.globalride-sf.org](http://www.globalride-sf.org)

*Access Exchange International (AEI)* has published the following guide which is freely available on the Internet or from AEI:

*Making access happen: Promoting and planning transport for all*

\* Available in English only at this time. For an electronic version, go to [www.independentliving.org](http://www.independentliving.org), and type 'Making Access Happen' in the search box.

[www.dpi.org](http://www.dpi.org)

*Disabled Peoples International* (Canada, in English, French, and Spanish) Regional offices and local chapters, with international and local advocacy.

[www.rumbos.org.ar](http://www.rumbos.org.ar)

*Fundación Rumbos* (Argentina, in Spanish)

Lo Urbano y lo Humano: Hábitat y Discapacidad. This multi-level introduction to the theory and practice of inclusive design can be ordered from this site.

[www.handicap-international.org](http://www.handicap-international.org)

*Handicap International: South Asia Regional Office* (India)

Promotes accessible transport in South Asia

[www.independentliving.org](http://www.independentliving.org)

*Institute on Independent Living* (Sweden)

- *Mobility for all: Accessible transportation around the world,\** and
- *Making access happen: Promoting and planning transport for all\**, AEI's guide to making transportation accessible for persons with disabilities and elders in countries around the world. (English\* and Spanish\*)

[www.iidisability.org](http://www.iidisability.org)

*Inter-American Institute on Disability* (USA, in English, Spanish, and Portuguese)

[www.ictaglobal.org](http://www.ictaglobal.org)

*International Commission on Technology and Accessibility (ICTA)* (Australia) Focus on access to the built environment

[www.libreacceso.org](http://www.libreacceso.org)

*Libre Acceso* (Mexico)

Helpful information on accessibility audits in Spanish\*

[www.miusa.org](http://www.miusa.org)

*Mobility International USA*. Leadership training, international exchanges. MIUSA may be contacted to order 'Building an inclusive development community: a manual on including people with disabilities in international development.'

[openword@sepia.ocn.ne.jp](mailto:openword@sepia.ocn.ne.jp)

*Open World/SATH*. For information on advocacy of accessible transport in southeast Asia.

[www.rehab-international.org](http://www.rehab-international.org)

*Rehabilitation International*. RI has a growing interest in issues of accessible transport.

[sanjeevsach@hotmail.com](mailto:sanjeevsach@hotmail.com)

*Samarthya*. Advocates for accessible transport in New Delhi, India

[psreddy@rnd.bhel.co.in](mailto:psreddy@rnd.bhel.co.in)

*Society for Equal Opportunities for Persons with Disabilities*. Promotes accessible transport in state of Andhra Pradesh, India

[www.disabledpersonspenang.org](http://www.disabledpersonspenang.org)

*Society of Disabled Persons of Penang (Malaysia)*. Chinese version of AEI's 'Mobility for all: Accessible transportation around the world', may be ordered without charge from this source.

[www.gdrc.org/uem/sustran/sustran.html](http://www.gdrc.org/uem/sustran/sustran.html)

*SUSTRAN: The Sustainable Transport Action Network for Asia and the Pacific*. Taking steps: a community action guide to people-centred, equitable and sustainable urban transport\* (English).

## Planning

[www.globalride-sf.org](http://www.globalride-sf.org)

*Access Exchange International (AEI)* has published the following guide which is freely available on the internet or from AEI:

*Making access happen: Promoting and planning transport for all*

\* Available in English only at this time. For an electronic version, go to [www.independentliving.org](http://www.independentliving.org), and type 'Making Access Happen' in the search box.

[www.ncsu.edu](http://www.ncsu.edu)

*Center for Universal Design* (North Carolina State University, USA)  
The Principles of Universal Design\*

[www.fta.dot.gov/ntl/planning](http://www.fta.dot.gov/ntl/planning)

*Federal Transit Administration (USA)*. Planning Guidelines for Coordinated State and Local Specialised Transportation Services\* An extensive list of planning elements is found in Chapter 5.

[www.rpd.es](http://www.rpd.es)

*Real Patronato* (Spain). *Guía para la Redacción de un Plan Municipal de Accesibilidad* (A guide to the preparation of a municipal access plan, with a chapter on transportation planning, in Spanish)

[www.tc.gc.ca/tdc](http://www.tc.gc.ca/tdc)

*Transportation Development Centre* (Canada) Publications on accessible transportation include:

- *Making transportation accessible: A Canadian planning guide.*
- *Access to transport systems and services: An international review* (English and French versions)
- *Improving transportation information: Design guidelines for making travel accessible.*

## **Implementation of accessible transportation, facilities and pedestrian ways**

[www.globalride-sf.org](http://www.globalride-sf.org)

*Access Exchange International (AEI)* has published the following guide:  
*Mobility for all: A guide to making transportation accessible for persons with disabilities and elders in countries around the world.*

- \* English and Spanish versions of ‘*Mobility for all*’ may be downloaded from the web site of the Swedish Institute on Independent Living at [www.independentliving.org](http://www.independentliving.org). Type in ‘*Mobility for all*’ (English version) or ‘*Movilidad para Todos*’ (Spanish version) in the search box.
- \* A Portuguese version of ‘*Mobility for all*’ is available as Part B of *Facilitando o Transporte para Todos*, a publication of the Inter-American Development Bank which may be purchased by going to their web site at [www.iadb.org/pub](http://www.iadb.org/pub).
- \* A Chinese version of ‘*Mobility for all*’ can be obtained by contacting Kuan Aw Tan at Penang, Malaysia’s, Society of Disabled Persons, at [tanka@pc.jaring.my](mailto:tanka@pc.jaring.my).
- \* A Japanese version is also available and versions in Indonesian, Malay, and Telugu are in preparation.

[www.trans.gov.ab.ca/Content/doctype369/production/pedaccdesigng.pdf](http://www.trans.gov.ab.ca/Content/doctype369/production/pedaccdesigng.pdf)  
*Alberta Transportation and Utilities (Canada). Design guidelines for pedestrian accessibility,\** including bus stop design diagrams

[www.access-board.gov](http://www.access-board.gov)

*Americans with Disabilities Act. ADA Accessibility Guidelines\**  
(pedestrian ways, facilities, transport vehicles)

[www.un.org/esa/socdev/enable/guiadd/aproddis.htm](http://www.un.org/esa/socdev/enable/guiadd/aproddis.htm)

*APRODDIS* (Asociación pro Desarrollo de la Persona con Discapacidad, Peru, in Spanish and English)  
*Manual de Diseño de Lugares Accesibles\** (an illustrated manual on accessible design, in Spanish)

[www.cepam.sp.gov.br](http://www.cepam.sp.gov.br)

*CEPAM (Centro de Estudos e Pesquisas de Administração Municipal).*  
Contact CEPAM for a copy of ‘*Município Acessível ao Cidadão*’ in Portuguese, with a special focus on access to transport and pedestrian infrastructure.

[www.coliac.cnt.fr](http://www.coliac.cnt.fr)

*Comité de liaison pour l'accessibilité des Transports et du Cadre Bati (COLIAC)*. A primary resource in French.

[cnreecr@racsa.co.cr](mailto:cnreecr@racsa.co.cr)

*Consejo Nacional de Rehabilitación y Educación Especial (CNREE, Costa Rica)*. To request copies of bilingual publications in English and Spanish concerning access to national parks and protected areas. Publications include:

- *Guide to diagnose accessibility in a protected area.*
- *Guide for signaling, information and communication.*
- *Guide for the creation of an accessibility plan in protected areas.*

[www.dft.gov.uk](http://www.dft.gov.uk)

*Department for Transportation: Mobility and Inclusion Unit (United Kingdom)* Go to section titled 'Access for Disabled People.' Publications include:

- *Guidance on the use of tactile paving surface\** (Type the title in the search box.)
- *Inclusive mobility: A guide to best practice on access to pedestrian and transport infrastructure\** (Type 'Inclusive Mobility' in the search box.)
- *Current or proposed accessibility specifications for rail, \* bus\* and taxi\* vehicles* (See listings under 'Personal mobility' and 'Consultation papers'.)

[www.easrs.org](http://www.easrs.org)

*Environmental Access Advisory Service (Hong Kong)*

See the links to resources in Chinese and English on accessible public transportation modes in Hong Kong. This link provides an interesting model for other cities.

[www.oecd.org/CEM/pub/pubfree.htm](http://www.oecd.org/CEM/pub/pubfree.htm)

*European Conference of Ministers of Transport (France)*

Click 'Free pdf Publications' at the bottom of the page, then click the following titles:

- *Improving transport for people with mobility handicaps: A guide to good practice\**.
- *Transport and ageing of the population\**.
- *Charter on Access to Transport Services and Infrastructure\**.

[www.unit.org.uy](http://www.unit.org.uy)

*Instituto Uruguayo de Normas Técnicas*. Developing access norms for Latin America region. *Curso básico sobre Accesibilidad al Medio Físico* (in Spanish).

[www.iadb.org/pub](http://www.iadb.org/pub)

*Inter-American Development Bank (USA):*

- *Facilitando o Transporte para Todos* (in Portuguese, including a translation of AEI's *Mobility for all: Accessible transportation around the world*).
- *Facilitando el transporte para todos* (Spanish version).

[www.icat-ciat.org](http://www.icat-ciat.org)

*International Centre for Accessible Transportation* (Canada, in English and French), promoting universally accessible transportation systems.

[sinpromi@cabtfe.es](mailto:sinpromi@cabtfe.es)

*Sociedad Insular para la Promoción del Minusválido (Sinpromi)* (Spain, Spanish document). To order their *Manual del Reglamento de Accesibilidad de Canarias*

[www.un.org/esa/socdev/enable/designm](http://www.un.org/esa/socdev/enable/designm)

*United Nations Division for Social Policy and Development. A design manual for a barrier free environment\** (English)

[www.unescap.org/decade](http://www.unescap.org/decade)

*United Nations Economic and Social Commission for the Asia Pacific Region* (Thailand). Among several relevant publications:

*Promotion of non-handicapping physical environment for disabled persons: Guidelines\**.

*Production and distribution of assistive devices for people with disabilities\**.

[www.worldbank.org/sp](http://www.worldbank.org/sp)

*World Bank*. Go to 'disability,' then 'documents on line,' then 'World Bank documents,' then the icons for the following documents:

- *Mobility for the Disabled Poor\**
- *Transport, Poverty, and Disability in Developing Countries\**
- For reports from a January 2003 seminar on *Transport, Poverty, and Disability*, contact [bgregory@worldbank.org](mailto:bgregory@worldbank.org).

### ***Publications concerning specific transport modes***

[www.dptac.gov.uk/pubs/smallbus2001](http://www.dptac.gov.uk/pubs/smallbus2001)

*Disabled Persons Transport Advisory Committee (UK). Accessibility Specifications for small buses designed to carry 9 to 22 passengers (inclusive)\*.*

*Office of Official Publications of the European Community (Luxembourg)*

- COST 322: *Low Floor Buses* is available in hard copy only, go to [www.cordis.lu/cost-transport/src/cost-322.htm](http://www.cordis.lu/cost-transport/src/cost-322.htm)
- COST 335: *Passengers' Accessibility of Heavy Rail Systems*,\* go to [www.cordis.lu/cost-transport/src/cost-335.htm](http://www.cordis.lu/cost-transport/src/cost-335.htm)
- COST 349: *Accessibility of Coaches and Long Distance Buses for People with Reduced Mobility*, go to [www.cordis.lu/cost-transport/src/cost-349.htm](http://www.cordis.lu/cost-transport/src/cost-349.htm)

## **National and international associations of transport providers**

*(Materials on accessible transportation are often available at these sites or their links)*

[www.apta.com](http://www.apta.com)

*American Public Transportation Association*

[www.CommunityTransport.com](http://www.CommunityTransport.com)

*Community Transport Association (United Kingdom)*

[www.ctaa.org](http://www.ctaa.org)

*Community Transportation Association of America*

[www.uitp.com/home](http://www.uitp.com/home)

*International Association of Public Transport*



ISSN 0951-8797

***Enhancing the mobility of disabled people:  
Guidelines for practitioners***

**ORN 21**