

**OVERSEAS  
ROAD NOTE  
14**



***Hydrological design manual  
for slope stability in the tropics***





Transport Research Laboratory  
Old Wokingham Road  
Crowthorne, Berkshire, RG45 6AU



Overseas Development Administration  
94 Victoria Street  
London, SW1E 5JL

## OVERSEAS ROAD NOTE 14

# HYDROLOGICAL DESIGN MANUAL FOR SLOPE STABILITY IN THE TROPICS

Subsector:	Geoscience
Theme:	G5
Project title:	Terrain surveys and site investigations
Project reference:	R5606

**Copyright Transport Research Laboratory 1997. All rights reserved.**

This document is an output from a project funded by the UK Overseas Development Administration (ODA) for the benefit of developing countries. The views expressed are not necessarily those of the ODA.

### **Transport Research Foundation Group of Companies**

Transport Research Foundation (a company limited by guarantee) trading as Transport Research Laboratory. Registered in England, Number 3011746.  
TRL Limited. Registered in England, Number 3142272. Registered Offices: Old Wokingham Road, Crowthorne, Berkshire, RG45 6AU

## ACKNOWLEDGEMENTS

This manual was commissioned by the Overseas Centre (Programme Director: Dr J Rolt) and prepared at the University of Bristol. It was written by Professor M G Anderson, Dr D M Lloyd and Dr M J Kemp and is based on ODA funded research previously carried out at Bristol, and a final ODA project report submitted in 1989.

The co-operation from the Research Institute of the Malaysian Public Works Department is also gratefully acknowledged.

First Published 1997  
ISSN 0951-8797

## OVERSEAS ROAD NOTES

Overseas Road Notes are prepared principally for road and transport authorities in countries receiving technical assistance from the British Government. A limited number of copies is available to other organisations and to individuals with an interest in roads overseas, and may be obtained from:

Transport Research Laboratory  
Crowthorne, Berkshire, RG11 6AU  
United Kingdom

Limited extracts from the text may be reproduced provided the source is acknowledged. For more extensive reproduction, please write to:

Programme Director, International  
Division, Transport Research  
Laboratory.

# CONTENTS

	Page		Page
1. INTRODUCTION	1	5. INSTRUCTION 3	22
2. THE COMBINED SLOPE HYDROLOGY/ STABILITY MODEL	4	INSTRUCTIONS RELATING TO THE MEASUREMENT OF PERMEABILITY	22
THE HYDROLOGY MODEL	4	INSTRUCTION 3.1	
THE STABILITY MODEL	4	Determination of soil permeability for conditions below ground water level using piezometers	22
MODEL VALIDATION	5	INSTRUCTION 3.2	
MODEL APPLICATION	6	Determination of the permeability of soil above the groundwater level	22
ASSUMPTIONS AND LIMITATIONS OF THE COMBINED MODEL	7	INSTRUCTION 3.3	
3. INSTRUCTION 1	9	Field measurement of the saturated infiltration capacity of soils	23
THE USE OF SLOPE STABILITY DESIGN CHARTS IN STABILITY ASSESSMENT	9	INSTRUCTION 3.4	
INSTRUCTION 1.1		Laboratory permeability tests	23
When to use stability design charts	9	6. INSTRUCTION 4	26
INSTRUCTION 1.2		INSTRUCTIONS FOR PIEZOMETER MONITORING	26
How to use the developed slope hydrology/stability charts	10	INSTRUCTION 4.1	
4. INSTRUCTION 2	14	Piezometer selection based on ground water conditions	26
INSTRUCTIONS RELATING TO SUCTION STRENGTH RELATIONSHIPS		INSTRUCTION 4.2	
The use of the resistance envelope procedure	14	Calculation of the time lag, T, Equalisation ratio, E, and intake factor, F, for a piezometer	29
INSTRUCTION 2.1		INSTRUCTION 4.3	
Procedure for the construction of a resistance envelope for a slope	14	Choice of procedures available for improving the response characteristics of piezometers (if appropriate)	35
INSTRUCTION 2.2		INSTRUCTION 4.4	
Using the resistance envelope summary charts	14	Selection of the monitoring and data recording equipment for the piezometer system	35
INSTRUCTION 2.3		7. INSTRUCTION 5	38
Using the resistance envelope to determine the threshold soil water conditions for slope stability	17	INSTRUCTIONS FOR THE MEASUREMENT OF SOIL SUCTIONS	38
INSTRUCTION 2.4		INSTRUCTION 5.1	
Calculation of the likely average depth of the slope failure zone	17	Selection of instrument type based on monitoring range	38
INSTRUCTION 2.5		INSTRUCTION 5.2	
Implications of the resistance envelope method on slope instrumentation, stability analysis and remedial action	18	Selection of tensiometer equipment	39
INSTRUCTION 2.6		INSTRUCTION 5.3	
The use of the resistance envelope procedure in the choice of stability analysis method	18	Tensiometer response characteristics	41

	Page
INSTRUCTION 5.4	
Tensiometer installation, monitoring and maintenance	44
INSTRUCTION 5.5	
The measurement of suctions greater than 80kPa	44
8. INSTRUCTION 6	48
INSTRUCTIONS CONCERNING DATA LOGGER SYSTEMS	48
INSTRUCTION 6.1	
Selection of the data logger system	49
INSTRUCTION 6.2	
Choice of sensor	49
INSTRUCTION 6.3	
Transducer selection	49
INSTRUCTION 6.4	
Calculation of tensiometer and piezometer readings using a calibrated transducer	50
INSTRUCTION 6.5	
Selection of data loggers with solid state memory design	51
INSTRUCTION 6.6	
Other data logger system considerations: power consumption, reliability and security	51
APPENDIX A: Design Charts	53
LIST OF REFERENCES	57

# HYDROLOGICAL DESIGN MANUAL FOR SLOPE STABILITY IN THE TROPICS

## 1. INTRODUCTION

**1.1** The development of this manual arises from the perceived need to alter the decision process involved in the design, construction, analysis and maintenance of engineered slopes and embankments in the tropics. It therefore aims to be a source of reference and a guide to the practising geotechnical engineer with the purpose of improving awareness and account of the dynamic hydrological condition in slope design and stability assessment in the tropics.

**1.2** Standard approaches to slope design for slopes within the tropics have proved inadequate as evidenced by their failure, implying the need to account for some further factors in slope design - factors that obviously exert a controlling influence on stability conditions but which have been ignored in standard methods of analysis.

**1.3** In tropical residual soils most failures are caused by rainfall. Residual soil slopes are often unsaturated with the water table at depth due to the high permeability of the soil. Suctions can be expected to exist in the profile and these enhance the stability of the slope. With the infiltration of rainfall such suctions are reduced or even removed and can lead to the development of positive pressures in a perched water table zone. As a result there is a decrease in soil shear strength and in the overall mass stability of the slope.

**1.4** It is, therefore, critical in the analysis of slope stability in the tropics to account for the pore pressure distribution in cut slopes and embankments and most importantly, the dynamic variation of this distribution with time.

**1.5** Despite this fact the major emphasis of recent research has been concerned with mass strength and stability analysis procedures. Table 1 shows an assessment of the state of knowledge of the various aspects of slope stability predictions for Hong Kong as compiled by Hencher *et al.*, (1984). From this it can be seen that there is a significant deficiency in knowledge relating to groundwater and pore water pressure conditions and predictive capabilities. This is in spite of work that has emphasised the role of relationships between soil moisture deficit and rainfall to slope failures.

**1.6** It is the relative lack of success in moving from such relationships (successful though they have proved to be for landslide warning systems) to predictive capabilities for pore pressure distributions in hillslopes that lies behind the position regarding the state of knowledge of groundwater and pore pressures in the assessment of slope stability identified in Table 1.

**1.7** A new approach to slope stability analysis is described which considers the hydrological and hence stability system as dynamic, changing through time in response to rainfall infiltration. A combined slope hydrology stability model has been developed which is used to simulate the changes in soil moisture conditions within slopes in response to individual rainfall events. The model generated dynamic hydrological conditions are used as input soil moisture conditions for stability analyses using effective stress conditions. The stability analysis accounts for both the detrimental effects of positive pore pressures and the beneficial effects of soil suctions within the unsaturated zone of the profile as they change with time.

**1.8** The combined model has undergone validation and assessment using an instrumented field site in Malaysia and also by application and comparison of model generated results to a large sample of known stable and failed slopes in Hong Kong. The model characteristics, development and validation are discussed to the following section of this manual.

**1.9** The scheme has been used to produce design charts which provide a summary of the overall minimum factors of safety that result in response to particular storm events for a range of different slopes and antecedent conditions. These design charts are included in Appendix A of the manual. The charts allow a rapid assessment of the stability of a wide variety of potential slope conditions that accounts for the hydrological response of a slope to rainfall infiltration. They therefore represent a considerable advance on conventional stability charts in which hydrological conditions are treated as static. In addition these design charts are particularly useful in that they graphically high-light the importance of both antecedent moisture conditions and slope material permeability in controlling slope stability response to individual rainfall events - controls which are argued as important in controlling stability as material strength which is customarily used as the criterion for slope design.

**1.10** The purpose of this manual is to familiarise the geotechnical engineer with the importance of the dynamic hydrological control on stability for the tropical slope condition, the modelling procedure that has been developed to investigate it, the use of model generated design charts in slope design, and those procedures and measurement techniques that should be adopted in addition to standard procedures to allow a better appreciation and understanding of the stability of tropical residual soil slopes.

**Table 1: Assessment of the state-of-knowledge of the various aspects of slope stability predictions for Hong Kong conditions (updated from Hencher et al, 1984)**

Aspect	Current State-of-Knowledge for Hong Kong Conditions	Overall Rating of Knowledge
Methods of Stability Analysis	Janbu (1954, 1973) method of analysis for non-linear surfaces thought satisfactory. Recommended factors of safety of 1.2 to 1.4 are satisfactory (GCO, 1984). Computational data is often poorly handled (Lumsdaine & Tang, 1982).	Very good
Geometry of Failure	Post-failure geometry is easily defined. Often difficult to decide critical potential failure surface for design, especially where geology is complex (Hencher et al, 1984; Hencher & Martin, 1982; Hudson & Hencher, 1984).	Good to very good
Geology	Site investigation procedures are adequate, but descriptions often poor. Complex weathering profiles are difficult to describe (Hencher & Martin, 1982). Understanding of influence of geological details on hydrogeology is poor.	Fair
Shear Strength	Mass strength as distinct from sample strength is poorly understood. Laboratory tests are commonly used to determine saturated strengths of samples in terms of effective stress, but doubt exists about applicability of test results (Brand, 1982). Limited amount of insitu strength testing carried out (Brand et al, 1983). Weakening effect of relict joints recognised (Koo, 1982). Effects of boulder and corestone content unknown (Hencher & Martin, 1982).	Fair to Poor
Groundwater and Pore Pressures	Useful correlations available between landslides and rainfall (Lumb, 1975; Brand et al, 1984). Rapid changes in pore pressure with rainfall are very difficult to predict for design (Anderson et al, 1983). Only limited attempts made to model groundwater (Leach & Herbert, 1982). Extrapolation of insitu measurements seems best design approach (Koo & Lumb, 1981; Endicott, 1982). Some progress made with field instrumentation (Pope et al, 1982; Brand et al, 1983). Erosion pipes are important in transmitting water (Nash & Dale, 1983; Brand et al, 1986).	Poor

**1.11** The manual divides into two distinct sections. The first section provides a summary of the development and a description of the combined slope hydrology and stability modelling scheme. Direct application of the developed combined model is generally impractical due to the demands made on data and computational hardware and so the purpose of this section is to familiarise the reader with the assumptions and limitations of the developed model. The importance of an understanding of these assumptions cannot be over stressed as sensible application of the results generated by the scheme can only be undertaken with a full knowledge of those conditions that are, and are not, represented by the combined model.

**1.12** Results of multiple applications of the model are summarised in the form of design charts and a methodology for their application for rapid assessment of slope stability that accounts for the influence of dynamic slope hydrological conditions provided. The charts emphasise the important control the dynamic hydrological condition has on slope stability. It is therefore necessary that standard approaches to slope design and site investigation are augmented to take account of this fact. The second section of this manual provides a set of instructions that should be adopted to achieve this end.

**1.13** Instruction 1 details the scope and methodology of application of the developed design charts. The charts graphically illustrate the importance of the hydrological controls on slope stability - especially the effect on stability of slope antecedent conditions and material permeability. It is important to take account to these hydrological factors if suitable applications of the design charts are to be undertaken. Subsequent instructions therefore relate specifically to these points. Instruction 2 describes the Resistance envelope procedure. This approach allows rapid assessment of the form of the hydrological controls on slope stability for any existing slope. Such information is of particular use in the choice and location of instrumentation, the form of stability analysis required, and assessment of the remedial action required if a slope has experienced failure. Instruction 3 provides procedures for the measurement of slope material permeability. This has shown strong controls on slope hydrological conditions and hence stability. Determination of material permeability should be considered an essential part of any ground investigation concerning the construction of cut slopes, embankments, or works resulting in any change to hydrological conditions in existing slopes (both natural and man made). Similarly, accurate determination of antecedent conditions must also be considered essential in any such ground investigation. Instructions 4, 5, and 6 therefore relate specifically to the monitoring of soil moisture conditions. Instruction 4 concerns the use of piezometer systems, Instruction 5 the measurement of soil moisture conditions in the unsaturated zone of the profile and Instruction 6 the use of data logging systems. These instructions emphasise the factors that might otherwise not be taken into account, but which will

significantly affect the value of data obtained from any such monitoring schemes.

**1.14** These instructions should be used to complement standard site investigation procedures and stability analyses currently employed to allow improved assessment of slope stability conditions in the tropics.

## **2. THE COMBINED SLOPE HYDROLOGY/STABILITY MODEL**

**2.1** In view of the need to consider the short term over-storm response in the analysis of slope stability in the tropics the coupled slope hydrology/stability model has been developed. This scheme allows analysis of the effect of storm events on the slope hydrological conditions in both the saturated and unsaturated sections of the profile, and the resultant effect this has on the stability conditions. The scheme simulates the dynamic stability conditions allowing identification of the minimum factor of safety, the characteristics of the failure, and time of occurrence for any particular initial slope condition and rainfall event. The salient model characteristics are summarised below.

- 1) The scheme consists of a dynamic, 2-dimensional hillslope hydrology model directly coupled to a 2-dimensional slope stability analysis procedure.
- 2) The hydrology model predicts both positive and negative soil water pressure conditions, at each iteration step (model time increment), as they change in response to rainfall events. On each hour of the simulation, the current hydrological conditions are used as the hydrological input data for the stability analysis.
- 3) The stability model is capable of accounting for the influence on material strength of both positive and negative (suctions) soil water pressures in the analysis.
- 4) Both individual models are able to accommodate potential uncertainty in the input parameter values.

### **THE HYDROLOGY MODEL**

**2.2** The procedure adopted in the modelling of the slope hydrological system is a forward difference explicit block centred finite difference scheme. The hydrology model considers only two dimensions, modelling the soil moisture flow within a unit cross section of any given slope - a cross section that is assumed to be representative of the conditions within the slope. The scheme requires the model user to subdivide the slope into a series of columns which are themselves divided into cells, the centre point of which is assumed representative of the whole cell. The number of cells per column defines the surface topography of the slope and, as there is specified a maximum one cell difference between columns, it is the dimensions of the cells that affects the topographical resolution of the scheme.

**2.3** Having defined the surface topography and the profile depth to be modelled, the slope can be divided into two hydrologically distinct layers - this being achieved by

defining the depth of the top layer from the surface. This top layer is modelled as a band of uniform depth throughout the slope length. The hydrology model simulates the effect of infiltration, evaporation and surface detention. Inflow from the backslope and a drainage level at the base of the modelled profile can also be accommodated. Flow within the unsaturated zone is assumed vertical and to obey Darcy's law with the unsaturated hydraulic conductivity defined by the Millington and Quirk (1959) procedure. Lateral flow is modelled at the top of the saturated zone in each column. Flow is assumed to obey Darcy's law -hydraulic conductivity being equal to the saturated value and the hydraulic gradient equal to the gradient of the water table at that point.

**2.4** After cessation of rainfall, water is lost from the surface due to evaporation. A maximum rate is specified and the model applies a sine based function during daylight hours. Between 1800 and 0600 hours (assumed night time) evaporation is assumed to be a hundredth of its daily maximum.

**2.5** In instances where the rainfall results in the infiltration and surface detention capacities being exceeded, overland flow is initiated. The equations governing all these processes are given in Figure 1.

### **THE STABILITY MODEL**

**2.6** On each hour of the simulation of the slope hydrology a stability analysis model is evoked. In the combined model the Bishop's method of analysis is used to determine the stability of the slope. The soil moisture conditions predicted by the hydrology model are converted to piezometric head values before transfer to the stability model routine.

**2.7** The stability model accommodates the effects of both positive and negative soil water pressures on soil strength in the analysis. Like positive pressure, soil suctions are directly input into the Mohr Coulomb equation for soil shear strength with overestimates of shear strength being minimised by specifying a maximum negative head of 20kPa in the analysis.

**2.8** As soil moisture conditions change through time in response to rainfall infiltration, so the minimum factor of safety slip surface position can be expected to change. Within the stability analysis a search procedure for the minimum factor of safety slip surface is incorporated by specifying a grid of circle centres and a circle radius incrementing procedure. This allows analysis of a whole suite of potential slip surfaces, the minimum factor of safety slip surface obtained being assumed the overall minimum condition for that time period. Thus a picture of the dynamic slope stability response to changing soil hydrological conditions is developed.

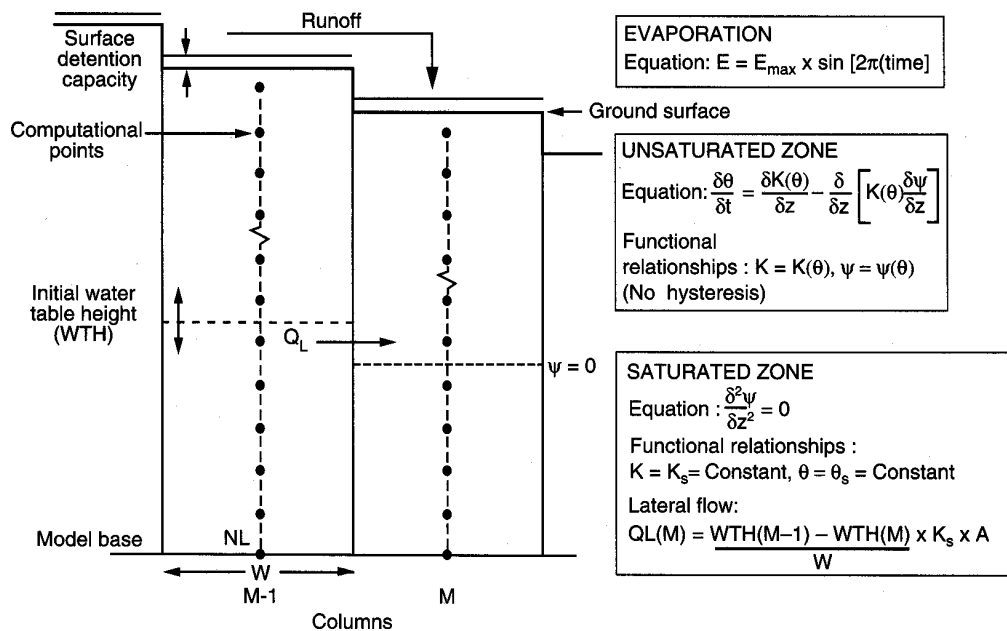

**Figure 1 Two dimensional soil water model: computational points and governing equations**

## MODEL VALIDATION

2.9 Model validation can be divided into three categories:

- 1) Mathematical validation: an assessment of the mathematical assumptions employed in the simplification of the physical system
- 2) Computational verification: the checking of the computer code after translation from mathematical equations
- 3) Operational validation: an assessment of the degree to which the physically based model compares with reality

2.10 Mathematical validation of a model is a subjective process as it involves the justification of the assumptions used in the simplification of the physical system. It also serves to familiarise the potential user with assumptions employed in the development of the model, preventing the use of the model in conditions whereby these assumptions may be violated.

2.11 Computational validation of the scheme has included tests on the computer code and both deterministic and stochastic sensitivity analyses.

2.12 Full operational validation of such physically based models is impossible due to the inherent variability of the natural system (no one condition is the same as another -full operational validation would require consideration of an infinite number of cases and parameters). However, it is

possible to falsify the model. Two separate but compatible approaches can be taken:

- 1) The comparison of measured soil water conditions with those predicted by the hydrology model. This approach is currently being undertaken. For this purpose a new instrumentation scheme has been designed, developed and installed on a cut slope on the Kuala Lumpur to Karak highway, West Malaysia. Data from this program has been used to compare observed against model predicted soil moisture conditions. An example comparison is given in Figure 2. The resolution of the modelling mesh is such that the predicted soil moisture response is for a depth of 50cm, whilst the observed value is at a depth of 15cm. The lagged and damped response of the predicted values in comparison to the observed is therefore expected in this example comparison.
- 2) The application of model predicted conditions (stable/failed) to a large sample of cut slopes, some of which have been observed to fail, others that are apparently stable. This approach has the major advantage that, at the current stage of model development, it provides information to evaluate the performance of the model and also determine the scope of design charts required for engineering applications. This has been successfully undertaken in Hong Kong where some 40 slopes with detailed site investigation information were analysed. Design charts (summaries of results of simulations for a range of antecedent and rainfall conditions) generated from application of the combined model

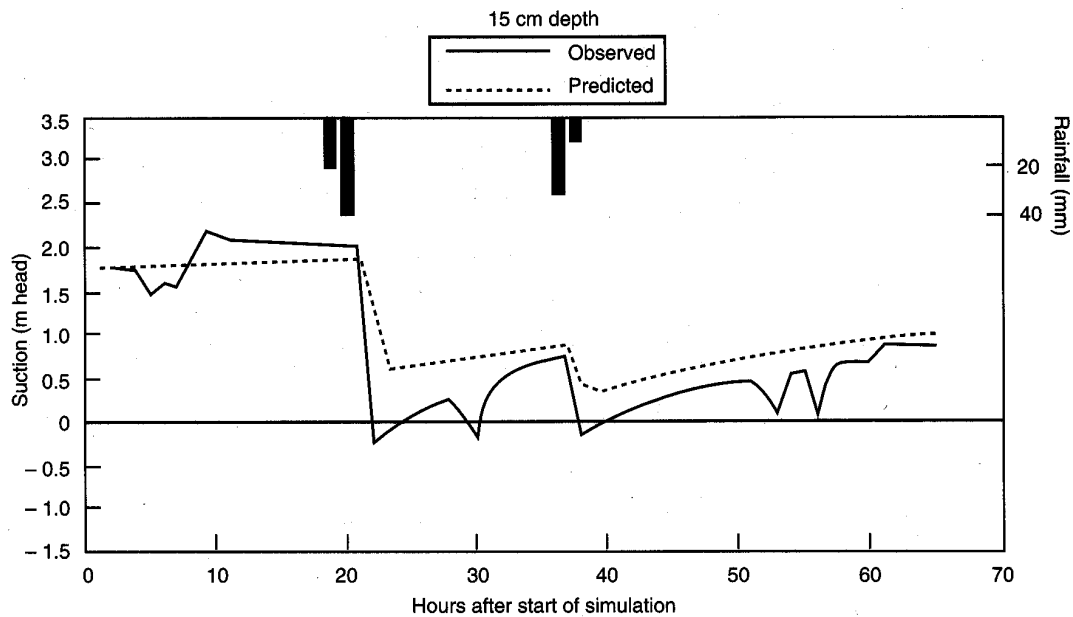

**Figure 2 An example comparison of observed soil water suctions and model predicted values**

correctly classified 77% of the field failed slopes and 68% of the field stable slopes. This represents a considerable improvement over other currently available slope stability charts which gave a percentage correct classification no greater than 50%.

## MODEL APPLICATION

**2.13** There are eight parameter groups that are necessary to run the combined hydrology/stability scheme. These comprise:

- 1) Evaporation
- 2) Rainfall
- 3) Initial near surface soil moisture conditions
- 4) Initial ground water table
- 5) Slope height
- 6) Slope angle
- 7) Soil permeability
- 8) Soil strength

**2.14** Evaporation is defined by a daily maximum value to which the model applies a sine based function. Rainfall is most usefully defined as a return period event (design storm)- a 24 hour 10 year return period event for example. The remaining parameters need to be determined from site investigation. Where such information is not available then reasonable estimates based on experience and available information need to be made.

**2.15** In addition to the assessment of the dynamic stability conditions of a cut slope in response to rainfall infiltration and drainage, the coupled scheme has the

facility to allow investigation of the effect parameter uncertainty has on the predicted result. Any measured parameter that is input into the scheme suffers from errors introduced by the sampling and measurement procedure. Input parameters can be randomly selected from distributions defined by their mean and associated standard deviations, and a distribution of output results developed from multiple simulations of the model. If the input and output parameter distributions are normal then probabilities can be assigned to particular factor of safety values and slip surfaces for any given modelled condition. Though computationally intensive this technique allows for a much greater appreciation of the overall stability conditions and likely failure characteristics of any modelled slope, see Figure 3.

**2.16** It is often necessary to be able to form a rapid assessment of stability conditions for a particular slope (or large number of slopes) and individual application of the model to enable this would be impractical. Consequently the combined model has been applied to a range of slope conditions (both slope form and antecedent conditions) with varying characteristics (soil strength and hydrological properties), and the results summarised in the form of 'design charts'. Such design charts provide a quick reference data source that allows rapid assessment of the minimum factor of safety condition in response to specified rainfall events for a range of potential slope conditions. Any slope can be matched to its nearest idealised modelled slope, and an assessment made of the stability which accounts for the effect of storm rainfall infiltration. This form of analysis is described in Instruction 1 of this manual.

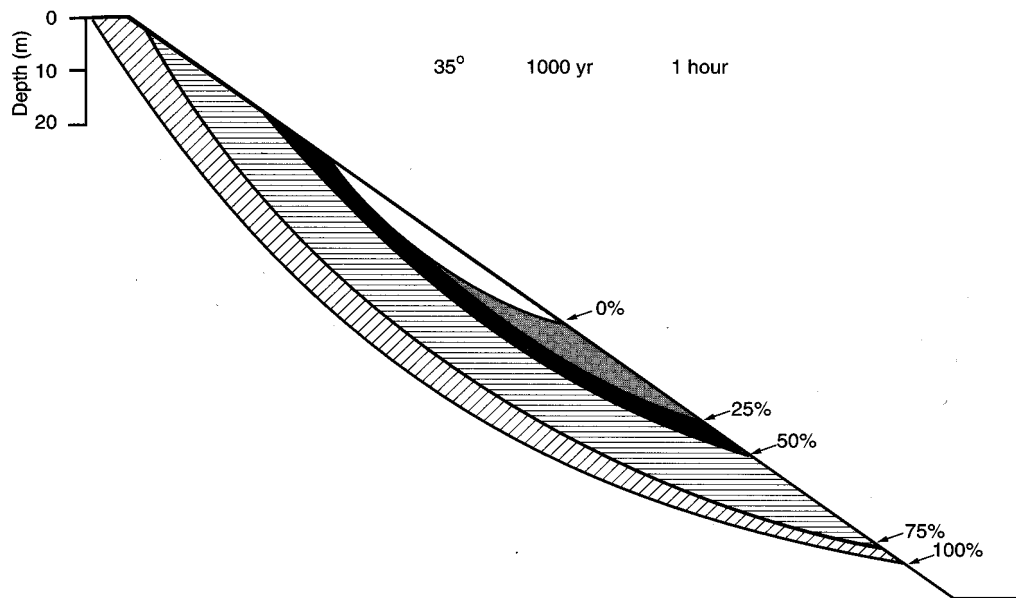

**Figure 3 Probability (%) of the failure surface being above illustrated surfaces, with assumed input parameter variability for a 35° slope and a 1000 year storm event**

#### ASSUMPTIONS AND LIMITATIONS OF THE COMBINED MODEL

2.17 In the development of a model of a physical system assumptions need to be made to simplify the problem to one of practical proportions. It is important to be aware of such simplifying assumptions so that applications of model generated results are not made to conditions whereby the modelling assumptions are violated. Hence, it is the aim of the following section to familiarise the potential design chart user with the assumptions made in the development of the combined slope hydrology slope stability model so that sensible applications of the resultant design chart product are made.

2.18 Important modelling assumptions include:

1) **Uniformity of material.** Throughout the hydrology and stability modelling process, homogeneity of both soil layers in the hydrology model and any defined zone of material to the stability model is assumed. Factors that may influence soil water infiltration and redistribution such as preferential flow paths (macropores, root channels), seepage, and the soil mass strength such as relict discontinuities are not considered. This assumption is considered reasonable for most tropical soil slope conditions. In conditions where such features may extend along significant sections of slope profiles then model predicted conditions cannot be considered wholly representative (being likely to overestimate the factor of safety) of actual stability conditions.

- 2) **The resolution of the scheme.** Temporal resolution of the stability analysis is every hour of the simulated hydrological conditions. It is assumed that between hour variation in the stability conditions is not of a magnitude significant enough to affect identification of, or anything other than insignificant error in, the minimum stability conditions for any modelled rainfall event. Over the range of conditions considered by the design charts this assumption is considered valid. For hillslopes consisting of highly porous, coarse, sandy soils ( $K_{sat} > 10^{-4} \text{ms}^{-1}$ ) this will not be a valid assumption. However, it is unlikely that rainfall intensities, even in the tropics, will approach these permeability rates and a net loss of soil moisture will occur. This will result to improved stability conditions and so it is unlikely that the combined model, as a result of temporal resolution, will overestimate the factor of safety conditions in this circumstance.
- 3) **The form of the stability analysis.** The analysis of the stability conditions is achieved using the Bishop's method assuming a circular failure surface. The majority of observed failures in steep tropical residual soil slopes are shallow and near circular in cross section. Where failure surface location is influenced by material property variation such as relict discontinuities (resulting in wedge and block failure) this form of analysis is unsuitable and the design charts would not provide accurate assessment of the slope factor of safety conditions.

4) **Shear strength envelope.** Whilst effective stress conditions are represented by the combined model it is assumed that the shear strength envelope is linear. At low stress levels, such as in very shallow failures, this may not be representative of the actual conditions (see for example Crabb and Atkinson, 1991; Perry, 1994). It is therefore important that the appropriate soil strength (or range of soil strength) conditions are considered when making an assessment of stability using the design charts.

### 3. INSTRUCTION 1

#### THE USE OF SLOPE STABILITY DESIGN CHARTS IN STABILITY ASSESSMENTS

**3.1** An important part of most slope analyses is the determination of the stability of the slope usually in terms of its factor of safety. This is conventionally achieved by carrying out a full stability analysis usually using a computer package which can be a time consuming process. Rather than carrying out detailed analysis of a slope it is often more practical to utilise 'design charts'. These summarise the results of a large number of analyses of stability for 'typical' slope forms and ranges of potential slope conditions. By the use of such design charts rapid assessment of stability is possible for a range of potential conditions (strength and hydrological). There is, therefore, great utility in providing easy to use look-up charts.

**3.2** Existing stability charts serve a useful purpose but are **limited by their poor representation of the soil water conditions**. Generally, soil suction is ignored in such analyses and water table representation is poor. Most importantly, all commonly used stability charts assume only static hydrological conditions, no account being made of the effect rainfall has on the hydrological condition and consequently stability. This factor is considered essential for the improved analysis of slope stability in the tropics.

**3.3** Application of the developed combined hydrology slope stability model to any standard engineering analysis of stability, though preferential, is limited by the model's demand on data, computational hardware requirement, and the need for system familiarity. This, in combination with the need for rapid assessment of stability, emphasises the utility of design charts that summarise results of model simulations.

**3.4** The developed model has been applied to provide **design charts** that summarise the dynamic response in the factor of safety (in terms of the overall minimum factor of safety) to a specified return period rainfall event for a representative set of initial slope conditions. An example of the developed slope stability design chart is illustrated in Figure -1.

**3.5** The suite of potential input conditions covered by the design charts are summarised in Figure 5. The summary of design charts are given in Appendix A.

**3.6 Rainfall** - Previous studies of slope instability in the tropics have shown correlation between landslide occurrence and the 24 hour rainfall total (Brand et al, 1984). Four 24 hour rainfall events have been used in the development of the design charts, these being 250mm, 350mm, 450mm and 550mm. By matching the 24 hour design rainfall, for any particular return period, to those used for the development of the design charts, the factor of safety (for any particular slope condition) can be determined.

**3.7 Slope form**- The charts have been specifically developed for application to engineered cut slope/embankment design and hence summarise slope stability response for the four slope angles of 2:1 (63°), 1:1 (45°), 1:1.5 (34°), 1:2 (27°). Slope heights range from 6 meters to 36 metres in 6 metre height increments.

**3.8 Soil characteristics** - The range of soil strengths is designed to envelope those expected in the tropical soil conditions (see Figure 5). Similarly the soil permeability values used in the design charts aim to represent the range of values that can be expected in the majority of cases in the tropical condition ( $1 \times 10^{-7} \text{ms}^{-1}$  -  $1 \times 10^{-5} \text{ms}^{-1}$ ).

**3.9 Antecedent conditions** - The initial surface soil moisture condition for the sake of simplicity is limited to consideration of a 1 metre suction equivalent and a uniform suction gradient to the water table is assumed. Four initial water table conditions are represented in the charts - the water table is assumed to pass through the slope toe and to extend upslope to a level expressed as a percentage of the slope height at the top of the slope (0%, 25%, 50%, & 75%).

**3.10** The important relationship between hydrology and stability is apparent from comprehensive analysis of the stability response to the 24 hour rainfall events provided by the design chart factor of safety data base. Initial water table height and soil permeability exert strong controls on the stability of slopes, the influence of which is argued as important as that of the strength of the soil ( $c'$ ,  $\phi'$ ).

**3.11 These results serve to emphasise the need for thorough investigation of slope hydrological conditions in the analysis of slope stability in the tropics.**

#### INSTRUCTION 1.1

##### When to use the slope stability design charts

**3.12** Standard engineering slope stability charts are used in the assessment of stability conditions in the absence of a full analytical analysis. The accuracy of the prediction depends on the closeness of fit between the actual slope characteristics and the chart assumed conditions. Differences between the two approaches result from the resolution of the stability charts in terms of the profile, soil material strength and soil water conditions. However upper and lower band estimates can be established and an indication of the likely range of values obtained. If this range is large then a more detailed analysis will need to be undertaken.

**3.13** Standard slope stability charts such as those of Bishop and Morgenstern, and Janbu should be considered for:

- 1) Initial approximate stability predictions
- 2) Slope stability analysis in the absence of a more detailed stability assessment
- 3) Highlighting those slopes that require more detailed analysis.

## FACTOR OF SAFETY

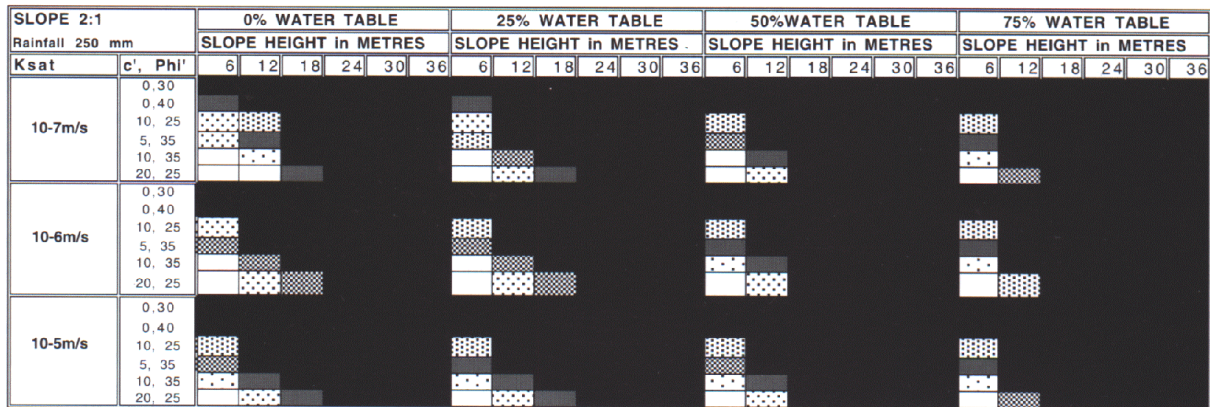
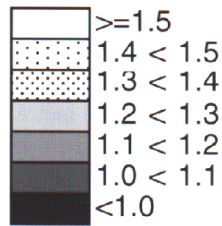

**Figure 4 Example design chart for a 250mm 24 hour rainfall event and slope cut at 2:1**

3.14 However such charts only provide a summary of conventional slope stability analysis methods. As such they represent static analyses with defined static soil moisture conditions - no account is made of the dynamic hydrological conditions. As a result, analyses usually take the form of assessment of the stability for an assumed worst case condition - that is a condition hydrologically that is considered the worst the slope is likely to experience. Estimation of such worst case conditions in the tropics is however difficult. By assuming a water table at the surface (as a theoretical worst case condition) over conservative designs will be derived with their associated unnecessary construction costs. Underestimation of the potential worst case soil moisture condition (maybe by a 'design by precedent' approach) can result in slope failure.

3.15 By using the model generated design charts which summarise the slope stability response to known recurrence interval rainfalls with 'realistic' initial water table conditions an improvement on both standard engineering charts and standard slope stability assessment methods is achieved. **For this reason it is recommended that the developed charts are used as part of any analysis of stability for the tropical residual soil condition.**

3.16 However, while the developed charts are considered to provide a more accurate and realistic assessment of tropical slope stability conditions to conventional forms of analyses (in that they account for the effect of rainfall on slope hydrology and stability) the **limitations of a design chart procedure must be appreciated.** All slope charts are restricted to consider slopes that have an approximately straight cross section in profile, simplified hydrological conditions (e.g. a specific groundwater level), homogeneous soil material of known shear strength, and a potential failure surface controlled by the stress conditions rather than by geological features.

### INSTRUCTION 1.2:

#### How to use the developed slope hydrology-stability charts

3.17 To use the design charts it is necessary to select a number of options so as to match the modelled condition to the slope of interest.

3.18 Figure 5 diagrammatically illustrates the modelled conditions covered by the design charts. These are

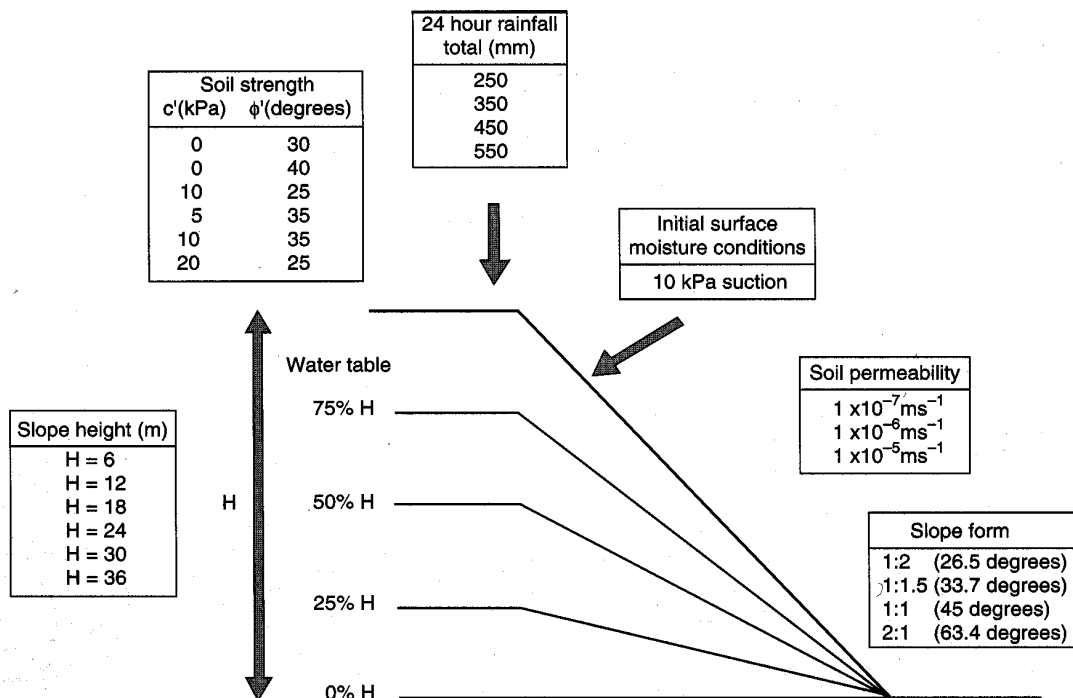

Figure 5 Summary of the range of conditions covered by the developed design charts

rearranged in Figure 6 to give structured choice diagram. The result of making these choices allows the most appropriate chart to be selected. These are displayed as separate charts for each slope angle and each design rainfall, giving 16 charts. Figure 4 gives an example design chart whilst the complete set of **design charts are listed in Appendix A** of this manual.

To fully utilise the developed charts the following input information is required:

- 1) 24 hour rainfall for a specified return period
- 2) Slope height
- 3) Slope angle
- 4) Soil permeability
- 5) Water table height
- 6) Soil strength

**3.19** The use of the developed charts is best illustrated by example. Consider a slope which has the following (approximate) characteristics:

Soil Permeability	$1 \times 10^{-6} \text{ms}^{-1}$
Soil strength	$c' = 5 \text{kPa}, \phi' = 35^\circ$
Groundwater level	50% of the slope height at the top of the slope

Slope angle	1:1
Slope height	15 metres
Rainfall for area	450mm (total for a 24 hour 100 year event)

**3.20** Select appropriate chart from Appendix A, on the basis of rainfall (450 mm 24 hour event) and slope angle (1:1). Select the central section of the chart ( $K_{\text{sat}} = 1 \times 10^{-6} \text{ms}^{-1}$ ) and, as there is no specific 15 metre slope, obtain the factor of safety values for slope heights that envelope this value in the 50% water table height category for the relevant soil strength ( $c' = 5 \text{kPa}, \phi' = 35^\circ$ ). For the 12 metre slope the factor of safety is between 1.2 and 1.3 and for the 18 metre slope the factor of safety is between 1.1 and 1.2. It is therefore reasonable to assume that the factor of safety for the 15 metre slope is likely to be about 1.2. It is useful to note at this point the important influence that soil permeability has on the hydrological conditions and hence slope stability by alteration of the effective soil strength. For soils of the same material strength but permeabilities greater than  $1 \times 10^{-6} \text{ms}^{-1}$  this slope design would be unstable. This example serves to stress the importance of determining slope material permeability in site investigation (see Instruction 3).

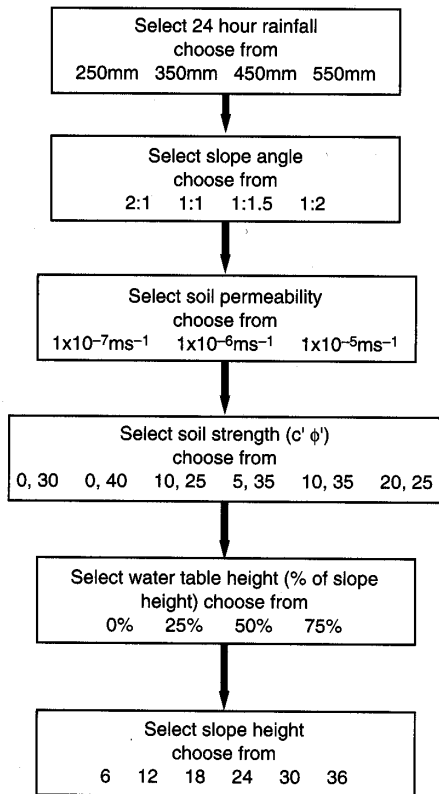

**Figure 6** Decision structure for design chart selection

# SUMMARY DECISION STRUCTURE FOR INSTRUCTION 1

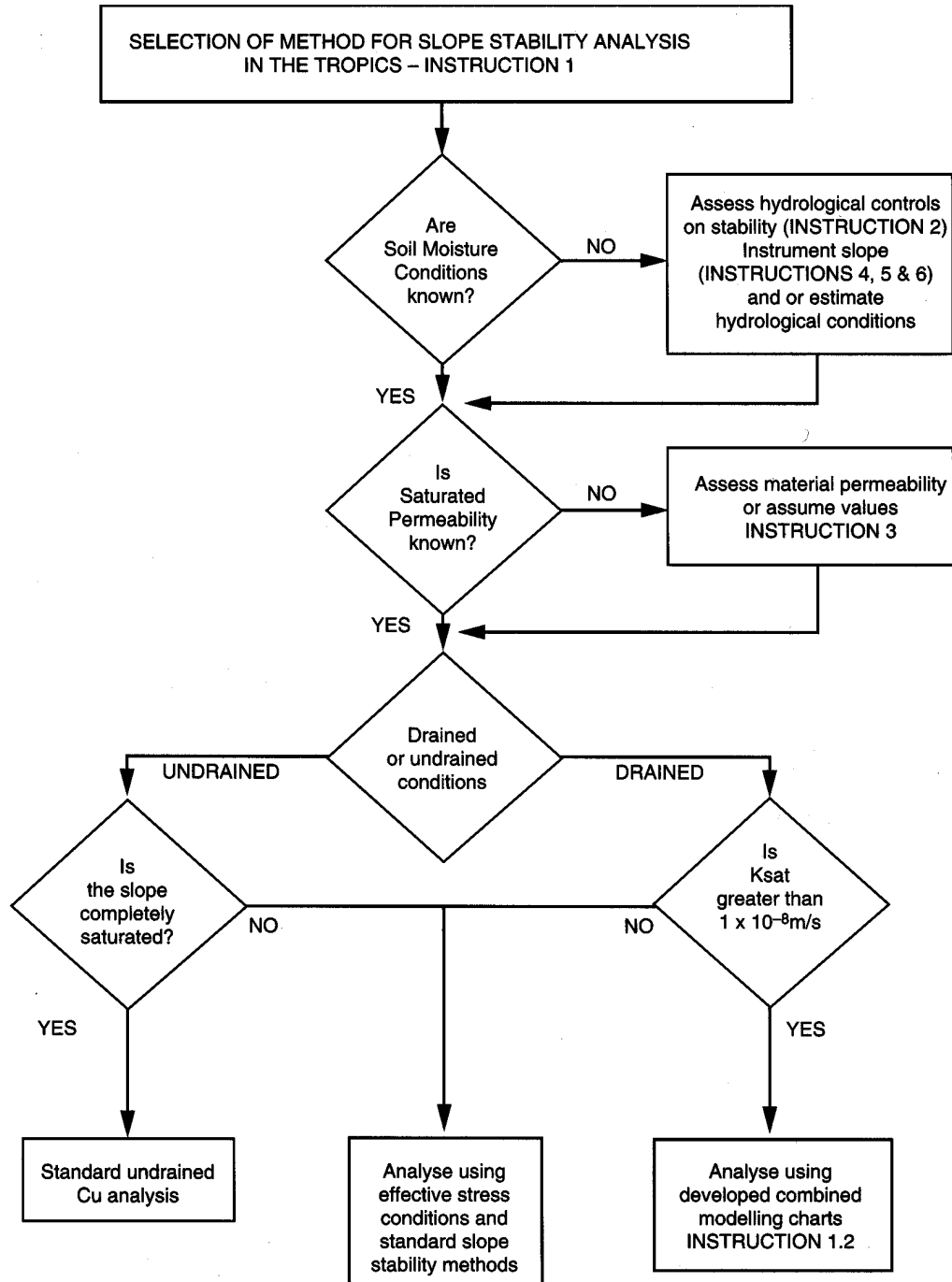

## 4. INSTRUCTION 2

### INSTRUCTIONS RELATING TO SUCTION/ STRENGTH RELATIONSHIPS

#### The use of the resistance envelope procedures

4.1 In this section the **resistance envelope** procedure is illustrated in terms of its utility in predicting the expected average soil water conditions which will initiate slope instability. Additional features allow for the rapid analysis of a number of slopes in terms of;

- 1) the hydrological controls on the stability
- 2) depth of the likely failure surface
- 3) an estimate of the existing factor of safety

4.2 **By using this procedure it is possible to advise on the type and installation of soil water instruments, the type of laboratory tests and the method of analysis that should be employed in the assessment of slope stability.**

4.3 Results from using the resistance envelope procedure and back analyses have shown that some slopes display a degree of suction controlled stability. This is shown by the fact that some slope failures occur even though soil suctions within the material still persist. If this is found to be the case, then validation may be necessary in the form of suction controlled laboratory tests such as that described by Anderson and Kemp (1987).

4.4 In instances where slope failures occur in partially saturated soil then the analysis and design of slopes should be by a methodology consistent with the actual slope conditions. The use of the effective stress theory for saturated soils is tried and tested and gives realistic predictions. This is not the case for partially saturated conditions in which suctions may be important. A number of attempts have been made to incorporate suction into an effective stress analysis directly. However, no straight forward solutions can be applied, making it necessary to clarify the most appropriate methodology.

4.5 The resistance envelope procedure can be used to graphically indicate the average equilibrium normal stresses within a slope. Envelopes have been constructed from a large number of previous analyses which have been organised in the form of a dimensionless chart - the envelopes being independent of slope material strength, Figure 7a. By using this chart the required strength for slope stability can be assessed from knowledge of only the slope profile and material density.

## INSTRUCTION 2.1

### Procedure for the construction of a resistance envelope for a slope

#### 4.6

- 1) Obtain and draw the slope cross sectional profile. A number of profiles may be necessary to account for variations in slope angle.
- 2) Obtain the slope angle ( $\beta^\circ$ ), slope height (H, metres) and soil material density ( $\gamma$ ,  $\text{kNm}^{-3}$ ).
- 3) Given the slope characteristics in (2) select a range of normal stress values ( $\sigma$ ) over which the envelope is required (for example, 0 - 150 kPa)
- 4) Determine the dimensionless normal stress component ( $\sigma / \gamma H$ ) by dividing the normal stress by the material density and slope height.
- 5) Using the dimensionless chart, Figure 7a, obtain the dimensionless shear strength component ( $\tau / \gamma H$ ) for the corresponding normal stress component and the given slope angle.
- 6) Obtain the shear strength ( $\tau$ ) by multiplying the shear strength component ( $\tau / \gamma H$ ) by the material density ( $\gamma$ ) and slope height (H).
- 7) The resistance envelope for the slope can now be drawn by plotting the values of normal stress ( $\sigma$ ) against the values of shear strength ( $\tau$ ) on an equal axis diagram.

An example of this procedure is given in Table 2.

## INSTRUCTION 2.2

### Using the resistance envelope summary charts

4.7 To simplify the above process, resistance envelope design charts for slopes cut a 1:1 (figure 7b) and 2:1 (figure 7c) have been constructed for a range of slope heights (10, 20, 30, 40, 50 metres). Each envelope has been constructed using the procedure described above assuming a soil density typical of a residual soil,  $18 \text{ kNm}^{-3}$ . To use these charts select the appropriate slope angle and trace the curve for the applicable slope height. For slopes that have a height between those illustrated interpolation between the nearest two slope heights should be undertaken.

**Table 2: Procedure for the construction of a resistance envelope**

$\sigma$ (kPa)	$\sigma / \gamma H$	$\tau / \gamma H$	$\tau$ (kPa)
0	0	0	0
5	0.01	0.011	5.5
10	0.02	0.022	11.0
20	0.04	0.043	21.5
30	0.06	0.063	31.5
40	0.08	0.076	38.0
50	0.10	0.097	48.5
70	0.14	0.125	62.5
90	0.18	0.140	70.0

Slope Height - 25m

Slope angle - 50 degrees

Material density - 20 KNm<sup>-3</sup>

- Select a range of normal stress values over which the envelope is required (e.g. = 0 to 150 kPa).
- Determine the dimensionless normal stress value by dividing the normal stress by the material density and slope height to give  $\sigma/\gamma H$ .
- Using the dimensionless chart, figure 7a, obtain dimensionless shear values ( $\tau/\gamma H$ ) for the corresponding normal stress values for the given slope angle.
- Determine the shear strength ( $\tau$ ) by multiplying the values in (c) by the material density and slope height.

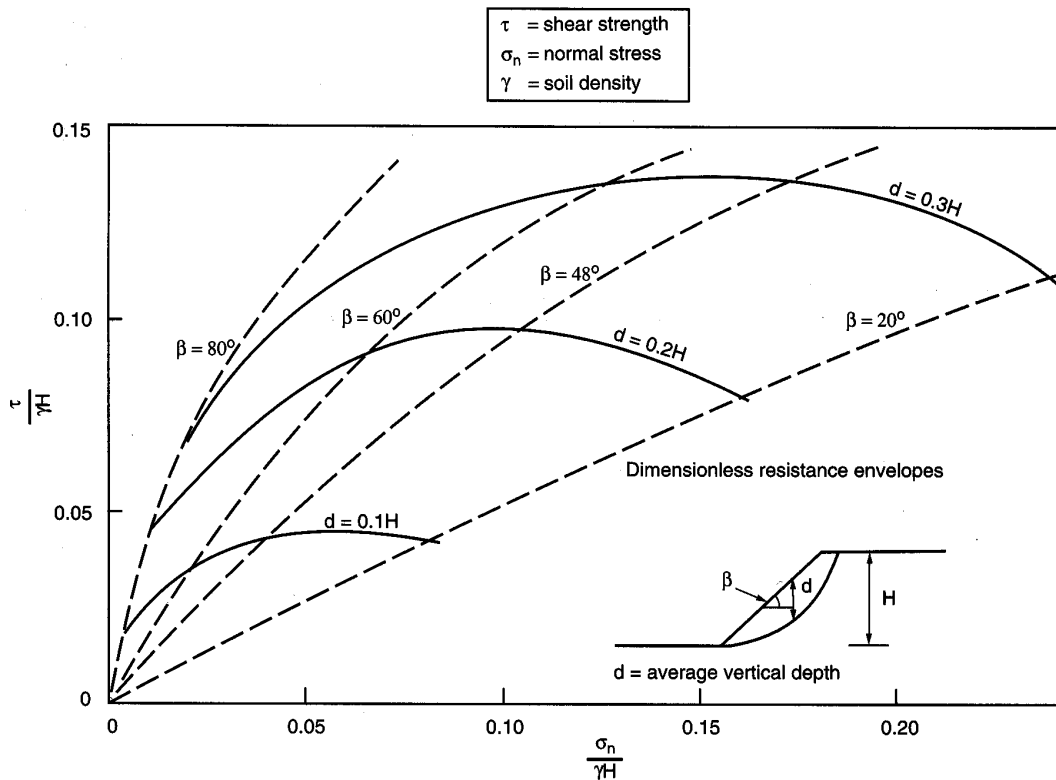

**Figure 7a Dimensionless resistance envelopes from which a resistance envelope for any slope angle ( $80^\circ > \beta > 20^\circ$ ) and height (H) can be generated**

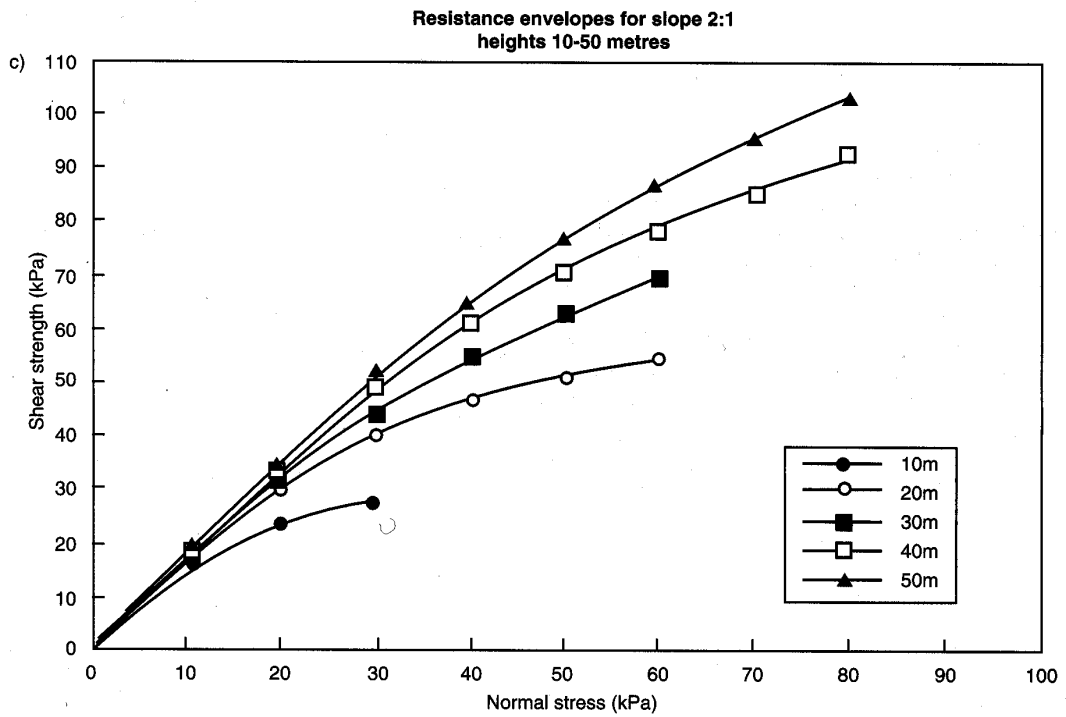
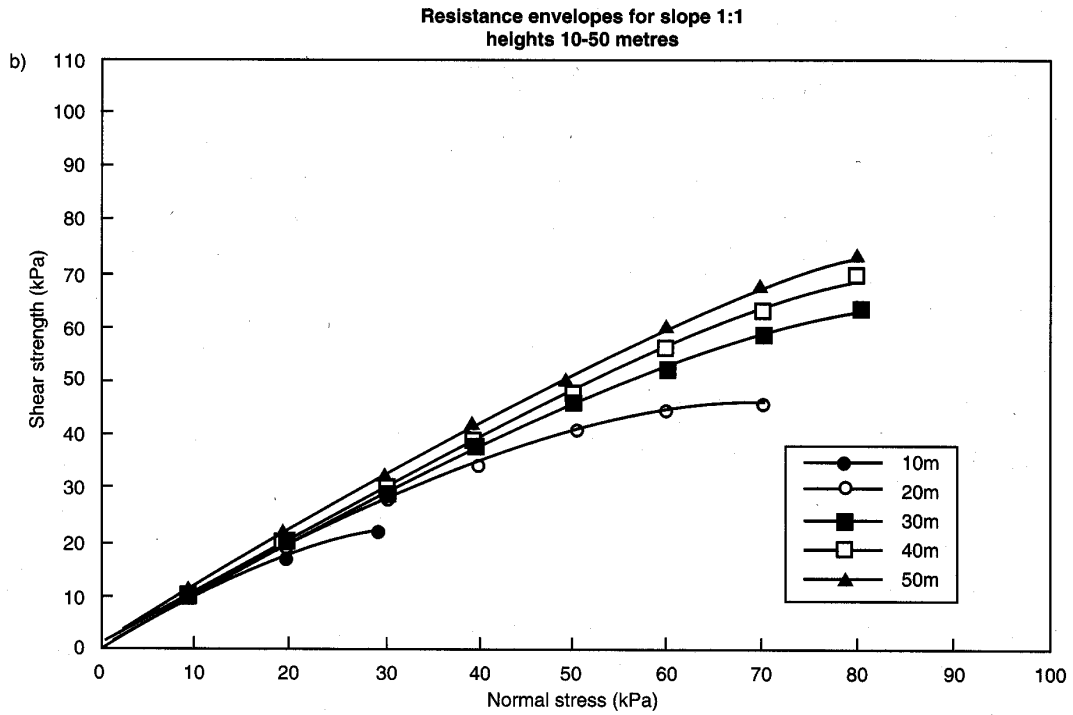

**Figure 7b&c Resistance envelopes for slopes of varying heights and angles 1:1 (b) and 2:1 (c)**

## INSTRUCTION 2.3

### Using the resistance envelope to determine the threshold soil water conditions for slope stability.

4.8 The resistance envelope constructed by following Instruction 2.1 or 2.2 represents the stability equilibrium conditions for a dry slope. By superimposing this envelope on the saturated shear strength envelope obtained from shear box (BS 1377 : 1990, part 7) or triaxial tests (BS 1377: 1990, part 8) of the slope material it is possible to identify the threshold soil moisture conditions required for stability equilibrium over a range of different normal stress levels. The resistance envelope approximates to the required shear strength to maintain stability and so, assuming stability is maintained, any differences in shear strength for a given normal stress when compared to the saturated envelope (the actual available shear strength) can be considered a function of the effective stress conditions. The normal stress condition which exhibits the greatest difference in shear stress when comparing the saturated envelope to the resistance envelope indicates the soil water conditions (in terms of negative pressures) necessary to maintain slope stability. This match can be obtained by a horizontal transformation of the saturated envelope by adjustment of the pore water value,  $u$ , as illustrated in Figure 8c. Three type conditions can thus be envisaged:

- 1) Figure 8a. The strength envelope always lies above the resistance envelope. The available strength is always greater than the required strength and instability will only be induced by the development of positive pore water pressures. In such circumstances a ground water rise or the development of a perched water table will control stability.
- 2) Figure 8b. The envelopes coincide at a particular normal stress giving stability equilibrium while at all other points the shear strength is greater than that defined by the resistance envelope. Instability at this common stress level may occur through the dissipation of suctions by infiltration or rise in ground water.
- 3) Figure 8c. A part of the strength envelope lies below the resistance envelope. For this stress range suction must be maintained to effect slope stability. The threshold suction required can be estimated from the lateral displacement of the two envelopes for the particular shear stress value.

## INSTRUCTION 2.4:

### Calculation of the likely average depth of the slope failure zone.

4.9 The comparison of resistance envelope to saturated strength envelope procedure described above can be used to provide an indication of the probable most critical normal stress condition - i.e. the normal stress condition at

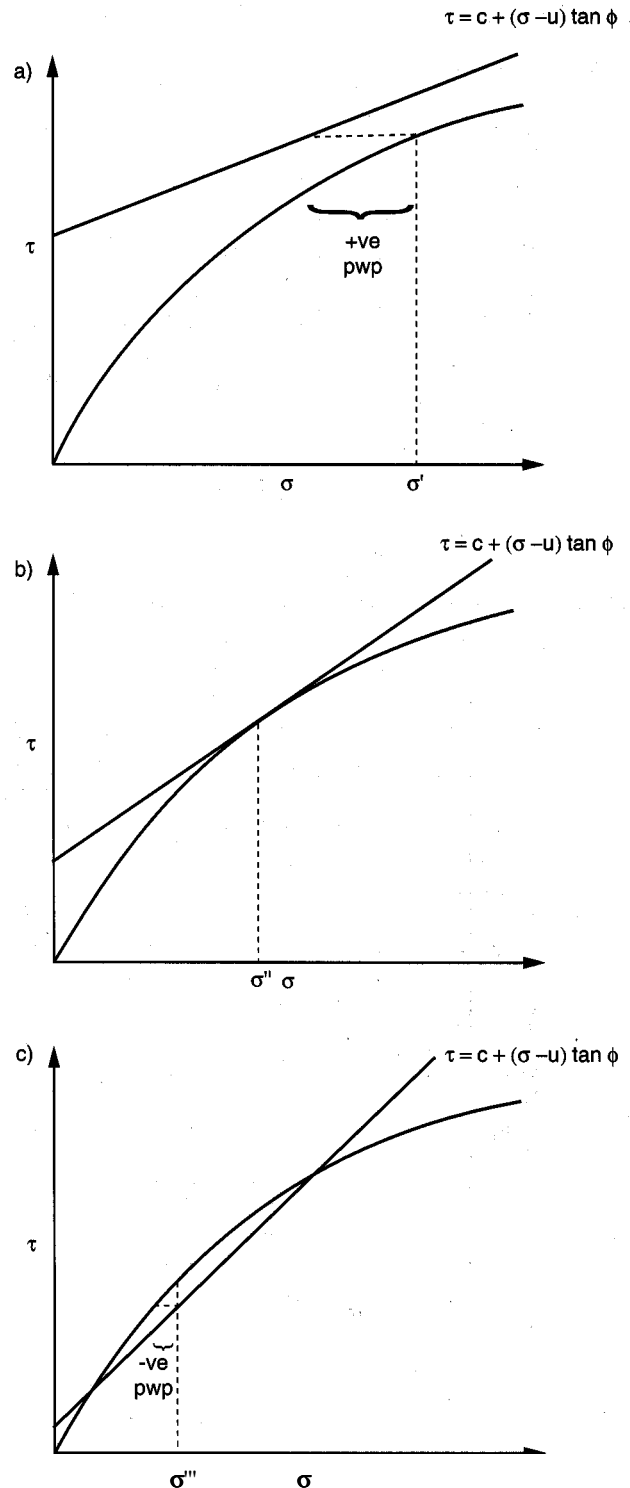

Figure 8 Three resistance envelope and shear strength relationships showing the equilibrium soil water conditions

which there is the greatest difference to shear stress. An approximation of the likely average failure depth can be obtained by dividing this normal stress value ( $\sigma$ ) by the material density ( $\gamma$ ) such that:

$$d = \sigma / \gamma$$

where:

$$\begin{aligned} d &= \text{average depth of failure zone (m)} \\ \sigma &= \text{critical normal stress (kNm}^{-2}\text{)} \\ \gamma &= \text{material density (kNm}^{-3}\text{)} \end{aligned}$$

**4.10** If a circular failure surface is assumed then it is likely the maximum failure depth will slightly exceed this value. The assumption of material homogeneity is made in this procedure. Where stability is controlled by discontinuities this technique cannot be expected to provide an accurate assessment of the likely failure depth.

### INSTRUCTION 2.5:

#### Implications of the resistance envelope method on slope instrumentation, stability analysis and remedial action

**4.11** A summary of the hydrological and slope stability implications of the results of the resistance envelope procedure is provided in Table 3. This table should be considered in conjunction with Figure 8. A number of recommendations can be made:

- 1) The technique can be used to help decide on the type of instrumentation necessary once the importance of positive and/or negative pressures on stability conditions has been established. The type of instrumentation program required, in relation to potential failure mechanisms, is described in Table 3.
- 2) The depth and position of instrumentation schemes can be identified in order to monitor conditions in the critical stress range, see Table 3.
- 3) The envelope characteristics can form the basis for advising on the type of slope stability analysis, in particular:
  - consideration of either deep or shallow slip circles
  - the form of treatment of the effective stress conditions and decisions made as whether to use the Fredlund et al (1978) approach to unsaturated soil stability analysis.
  - assess whether there is a need to obtain actual monitored data (for example when a suction control is identified) or whether simple ground water assumptions can be made.

4) An estimate of the minimum factor of safety can be obtained (see Figure 8) by dividing the saturated shear stress value ( $S_1$ ) by the resistance envelope value ( $S_2$ ) for the normal stress condition that exhibits the greatest difference in shear stress when comparing both envelopes.

5) The type and suitability of remedial works can be alluded to once the critical hydrological conditions have been established. Two type cases can be identified:

- slopes for which stability is not suction controlled. These will benefit most from remedial measures designed to reduce the ground water level (such as horizontal draining).
- slopes for which stability is controlled by suction. These will benefit from remedial techniques that prevent infiltration. Slope covers such as chunam and gunite (provided they are well maintained) can increase soil suctions by reducing infiltration and this in turn enhances slope stability. Additionally, any proposed change to slope vegetation should be carefully considered to ensure that surface infiltration is not increased and that sufficient evapotranspiration occurs to maintain soil suctions.

### INSTRUCTION 2.6:

#### The use of the resistance envelope procedure in choice of stability analysis method.

**4.12** When suction control is identified as a major component of stability equilibrium then it is realistic to include suction in the detailed analysis of slope stability. Standard analysis of stability uses the Mohr Coulomb relationship with effective stress conditions. In this circumstance the effective normal stress is represented by

$$\sigma' = \sigma - u_w$$

where:

$$\begin{aligned} \sigma' &= \text{effective normal stress} \\ \sigma &= \text{normal stress} \\ u_w &= \text{pore water pressure} \end{aligned}$$

**4.13** For low suction conditions (<20 kPa) then suction can be considered directly in the Mohr-Coulomb relationship, so that the effective normal stress is given by:

$$\sigma' = \sigma - u_{\text{suction}}$$

where:

$$u_{\text{suction}} = \text{soil suction (kPa)}$$

Table 3: Summary interpretation of the selected resistance envelope and shear strength relationships

Attributes	1	Examples 2	3
Slope stability conditions	$F > 1$ for zero pore water pressure (pwp)	$F = 1$ pwp = 0	$F < 1$ pwp = 0
Average failure conditions:			
(a) Soil water	positive pwp	zero pwp	negative pwp
(b) Depth of surface	$\sigma' / \gamma$	$\sigma'' / \gamma$	$\sigma''' / \gamma$
Mechanisms of failure	Build up of large pwp due to high infiltration recharge or poor drainage	Build up of any pwp	Reduction in soil water suction due to increase in soil water content
Instrumentation requirement	Monitor positive pwp at an average depth of $\sigma' / \gamma$ Use piezometers, type and response related to soil permeability	(a) Fast response piezometers at the critical depth $\sigma'' / \gamma$ (b) Tensiometers to monitor near surface tension (c) Rainfall records for design storm evaluation	(a) Fast piezometers at a depth $\sigma''' / \gamma$ plus deeper piezometers to pick up extent of the phreatic zone (b) Tensiometers to monitor infiltration processes, preferably automatic (c) Rainfall monitoring and records (d) Soil permeability and infiltration tests
Remedial measures	Improve and maintain slope drainage	As 1 but with additional drainage surface and internal. Use of vegetation and other natural and synthetic methods to restrict infiltration	As 2 but more comprehensive. Consider slope change and in extreme cases slope redesign

where pwp = pore water pressures

**4.14** If suctions Greater than 20 kPa are likely then direct incorporation of suction into the effective stress equation will lead to an over estimate of the suction effect and the analysis will be unrealistic. In these circumstances it is necessary to choose one of the following options

- 1) to specify a lower more conservative suction
- 2) define a maximum suction value of 20 kPa
- 3) adopt the Fredlund et al (1978) approach.

**4.15** Of these three approaches that of Fredlund et al (1978) is the only one to account for all stress state variable combinations within the analysis - the other two techniques simplifying consideration by ignoring the air/water phase, employing a conservative simplification to the analysis. The equation for analysis of slopes with matrix suctions greater than 20 kPa requires an additional independent variable ( $\phi^b$ ) which relates to the matrix suction ( $u_a - u_w$ ) such that:

$$\tau = c' + (\sigma - u_a)\tan\phi' - (u_a - u_w)\tan\phi^b$$

**4.16** The  $\phi^b$  has to be determined using sophisticated laboratory tests in which both the pore air and water pressures are controlled. This analysis can be simplified by assuming typical values of  $\phi^b$  and a rearrangement of the Fredlund et al (1978) formula. It can be shown that the air water interaction term can be simply incorporated into the standard Mohr Coulomb equation such that:

$$\tau = c_{new} + (\sigma - u_w) \tan \phi'$$

where:

$$c_{new} = c' + (u_a - u_w) (\tan\phi^b - \tan\phi')$$

that is, by modification to the cohesion component, analysis can be made of the actual shear stress conditions using the standard method of analysis.

**4.17** An average  $\phi^b$  value for a decomposed granite soil is given as 15.3° whilst for a decomposed rhyolite a value of 13.8° is suggested (Ho and Fredlund, 1982). Typically the  $\phi^b$  value has a standard deviation of  $\pm 5^\circ$ . For such analyses it is assumed that the  $u_a$  component has a value of zero.

## SUMMARY DECISION STRUCTURE FOR INSTRUCTION 2

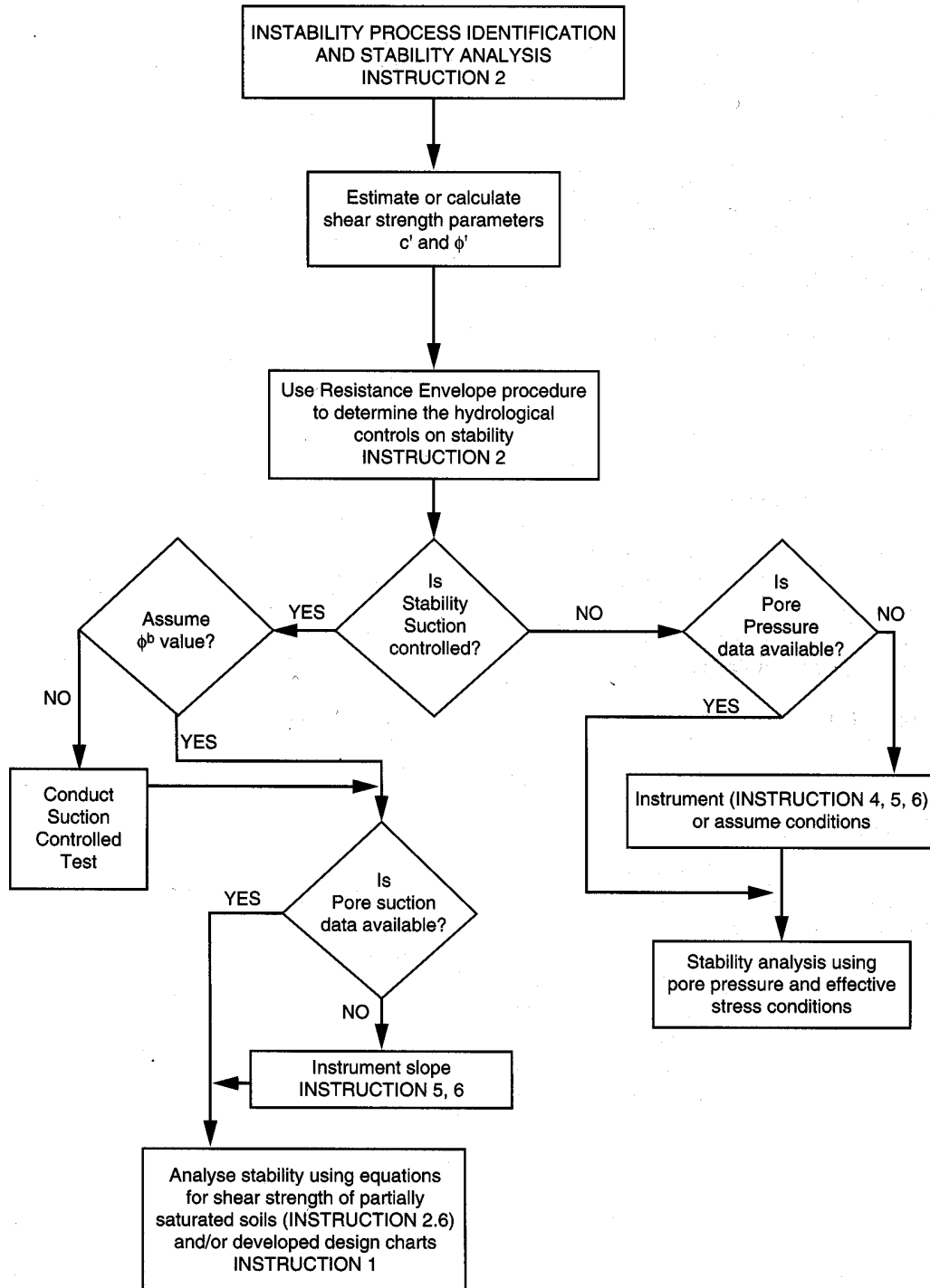

## 5. INSTRUCTION 3

### INSTRUCTIONS RELATING TO THE MEASUREMENT OF PERMEABILITY

5.1 The importance of permeability in controlling slope stability to the tropics has been shown in Instruction 1. It is therefore necessary, along with an assessment of the slope antecedent hydrological conditions, to identify the saturated permeability (saturated hydraulic conductivity) of the material forming the slope. It is the purpose of the following Instruction to detail the methods available for the measurement of permeability. **This should be considered as a necessary procedure during either site investigation or laboratory analysis of sample material, complementary to standard site investigation.** Standard site investigation procedures are reported elsewhere (BS 1377, BS5930, GCO, 1984) and are therefore not discussed here.

5.2 The determination of soil permeability can be achieved either in the field or in the laboratory and the method by which it is assessed is dependent on whether the soil being tested is saturated or unsaturated (above or below the groundwater level).

#### INSTRUCTION 3.1

##### Determination of soil permeability for conditions below ground water level using piezometers

5.3 Two test methods using the Hvorslev (1951) equations can be adopted for the measurement of permeability of soils using piezometers below the ground water level. These are

- 1) Constant head test
- 2) Rising or falling head test

##### 1) Constant head test

5.4 In this procedure the water level is maintained at a constant height in the piezometer standpipe. The volume of inflow or outflow required to do this can be used to assess the saturated permeability of the slope material at the piezometer installed depth. The permeability is defined by:

$$k = q / (F \cdot H_c)$$

where:

- k = Saturated permeability ( $\text{ms}^{-1}$ )  
q = Inflow or outflow rate required to maintain  $H_c$  ( $\text{m}^3\text{s}^{-1}$ )  
F = The piezometer shape factor (see Instruction 4.2)  
H = Water head above or below the standing groundwater level maintained at constant head (m)

##### 2) Rising or falling head test

5.5 In this test the change in hydraulic head over time is used to calculate the soil permeability. Saturated permeability is then defined by:

$$k = \frac{A \cdot \log_e (H_1 / H_2)}{F(t_2 - t_1)}$$

where:

- k = Saturated permeability ( $\text{ms}^{-1}$ )  
F = The piezometer shape factor (see Instruction 4.2)  
A = cross sectional area of the standpipe casing ( $\text{m}^2$ )

(If the casing is not vertical then the horizontal area should be used)

$H_1$  = Water head (m) at time  $t_1$  (s)

$H_2$  = Water head (m) at time  $t_2$  (s)

#### INSTRUCTION 3.2

##### To determine the permeability of soils above the groundwater

5.6 The method described above cannot be used for the determination of soil permeability above the groundwater level as the assumption that saturated flow is maintained is broken. Steady state conditions can only be used if the test becomes very long (as  $t$  approaches infinity) and then the permeability can be determined using a constant head test. To approximate this situation through extrapolation it is necessary to plot the flow rate,  $q$ , against the reciprocal of the square root of time ( $1/\sqrt{t}$ ). When plotted in this form the test data should provide a linear relationship from which the flow rate at infinity can be calculated (by extending the line back to  $1/\sqrt{t} = 0$  allowing determination of  $q_{(\text{infinity})}$ ). Once this value has been obtained the permeability can be calculated from the constant head test equation such that:

$$k = q_{(\text{infinity})} / (F \cdot H)$$

where:

- k = Saturated permeability ( $\text{ms}^{-1}$ )  
F = The piezometer shape factor (see Instruction 4.2)  
H = Head measured from the centre of the piezometer ceramic to the level maintained in the standpipe for the test (m)

5.7 The methods described have detailed techniques for the measurement of soil permeability at depth (standpipe installed depth). It is also possible to determine the surface saturated permeability or saturated infiltration capacity.

This is defined as the maximum rate at which water will enter the soil surface by infiltration when the soil is saturated.

**INSTRUCTION 3.3:**

**Field measurement of the saturated infiltration capacity of soils**

5.8 The saturated infiltration capacity of a soil can be measured using a ring infiltrometer, Figure 9. The principle of the test involves the flooding of a known surface area of soil and then measuring the volume of water lost through the soil over a known time period. The infiltration rate is defined as:

$$IR = q/(A.t)$$

where:

- IR = Infiltration rate (ms<sup>-1</sup>)
- q = Volume of water lost (m<sup>3</sup>) in time t (s)
- A = Flooded surface area (m<sup>2</sup>)

5.9 The accuracy of the test can be improved by reducing

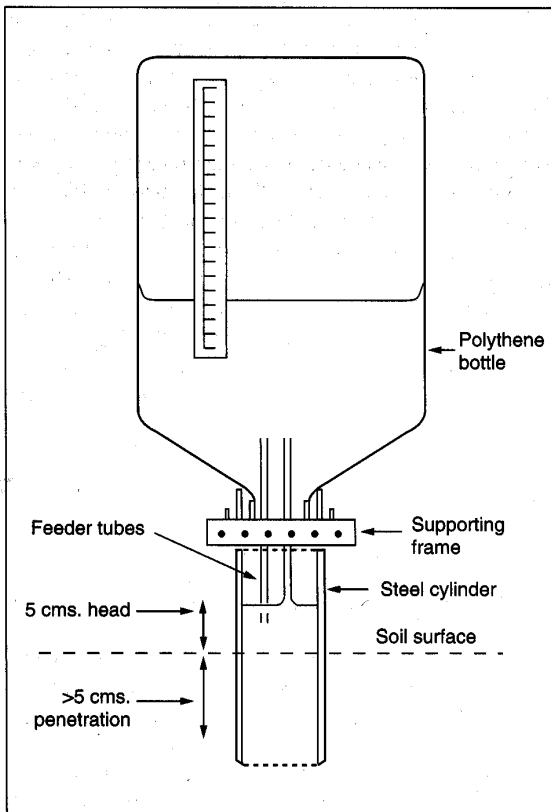

**Figure 9 Surface ring infiltrometer**

the boundary effects. This is achieved by installing a second ring that has a diameter twice that of the inner ring. The depth of the outer ring is most effective when it is below that of the soil wetting front during the test. As for Instruction 3.2 the flow rate, q, is plotted against the reciprocal of the square root of time to allow extrapolation to t=∞ and hence the saturated infiltration rate.

**INSTRUCTION 3.4:**

**Laboratory permeability tests**

5.10 As with field tests there are two techniques available for the determination of soil permeability:

**1) The constant head test**

5.11 Figure 10a illustrates the apparatus required for the determination of permeability in the laboratory using the constant head method. Saturated permeability is calculated from the following equation:

$$k = V.L/(A.t.H)$$

where:

- k = saturated permeability (ms<sup>-1</sup>)
- V = volume of flow (m<sup>3</sup>) in time t (s)
- A = horizontal surface area of the sample (m<sup>2</sup>)
- L = sample thickness (m)
- H = hydraulic head (m)

**2) The rising or falling head test**

5.12 Figure 10b illustrates the apparatus required for the determination of permeability in the laboratory using the rising or falling head approach. The saturated permeability of the sample is defined as follows:

$$k = (r_1^2.L/(r_c^2.[t_2 - t_1])).\log_e (H_1/H_2)$$

where:

- k = saturated permeability (ms<sup>-1</sup>)
- r<sub>1</sub> = radius of the head tube (m)
- r<sub>c</sub> = radius of the sample tube (m)
- L = sample thickness (m)
- H<sub>1</sub> & H<sub>2</sub> = water heads at time t<sub>1</sub> (s) and t<sub>2</sub> (s) respectively (m)

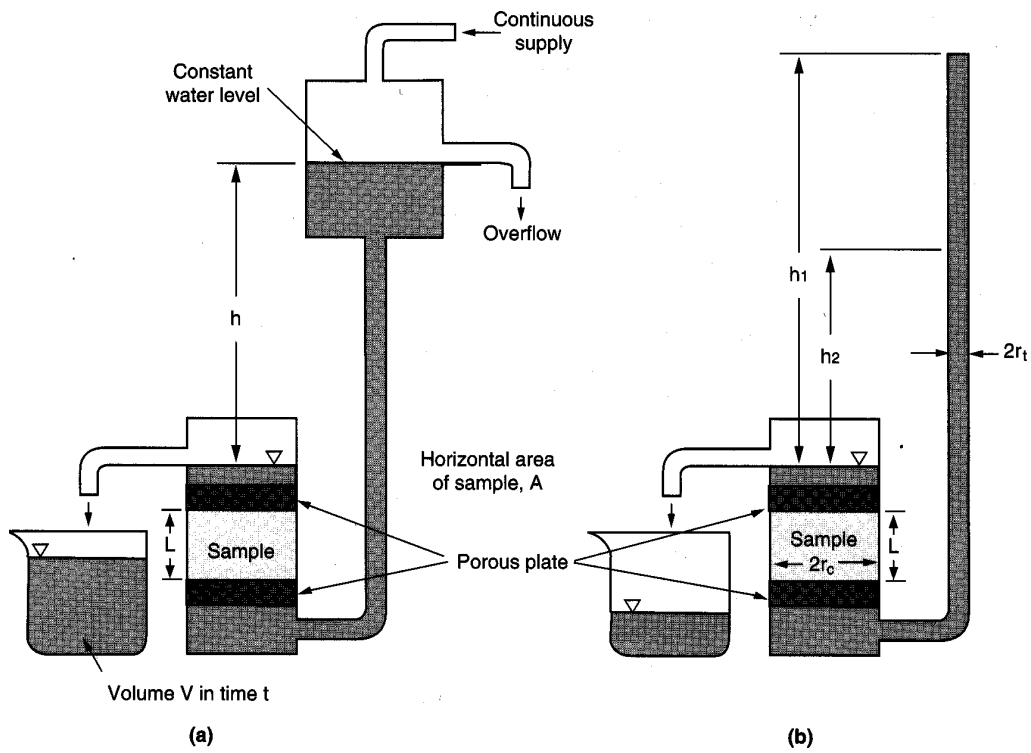

**Figure 10** Laboratory equipment for the measurement of hydraulic conductivity  
 a) constant head b) falling head

### SUMMARY DECISION STRUCTURE FOR INSTRUCTION 3

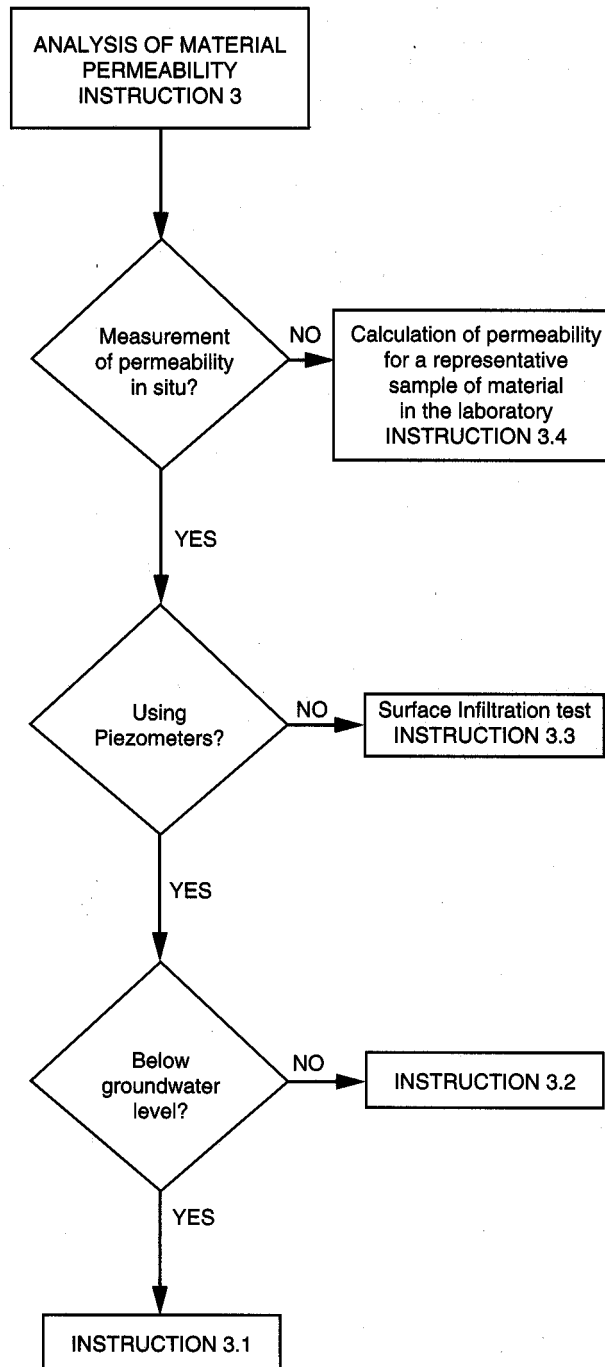

## 6. INSTRUCTION 4

### Instructions for piezometer monitoring

**6.1** Piezometers are used to monitor the pore water pressure conditions at a particular location and time beneath the ground surface. In this context it is a method by which the level and movement of the groundwater level can be established for input into a stability analysis. As a result of the variable nature of field groundwater and soil conditions a number of piezometer systems have been developed each with their own specific characteristics. For realistic and accurate measurement of conditions it is necessary to match the instrument specification to the likely groundwater response. To optimise performance the design most suited to the application required has to be determined.

**6.2** Figure 11 allows illustration of the decisions that need to be made when selecting a piezometer system. In most cases the piezometer selection can be made using Instruction 4.1 but the performance, design and installation need evaluation for particular applications so that the suitability of system to its application can be judged.

**6.3** The performance of a piezometer is represented by its time lag characteristics which can be determined experimentally in the field or by an empirical approximation. A long time lag will result in poor piezometer performance manifested by a delayed response to groundwater change and a reduction in the peak recorded value in comparison to actual values. The type, shape and installation characteris-

tics of piezometers affect the time lag and are factors that must be addressed in the choice of system for installation. Broadly, piezometers can be divided into two categories

- 1) **Open systems** in which the piezometer is vented to the atmosphere (high volume systems).
- 2) **Closed systems** in which the piezometer is sealed from the atmosphere (low volume systems).

**6.4** As well as considering the performance of the piezometer so must the operational aspects of groundwater monitoring be addressed. Many piezometer systems come with an integral data logging facility - when this is not the case others can be adapted (Instruction 6). The choice of either an automatic or manual system should be assessed in terms of the value of the data, the equipment reliability and system security.

### INSTRUCTION 4.1:

#### Piezometer selection based on groundwater conditions

**6.5** Figure 11 illustrates the piezometer selection procedure for four typical (observed or anticipated) pore pressure responses. Table 4 details the four response curves and the basic piezometer requirements whilst Table 5 summarises the characteristics of commonly used piezometer systems. A summary of piezometer selection based on anticipated response can be expressed as follows (with reference to Figure 11):

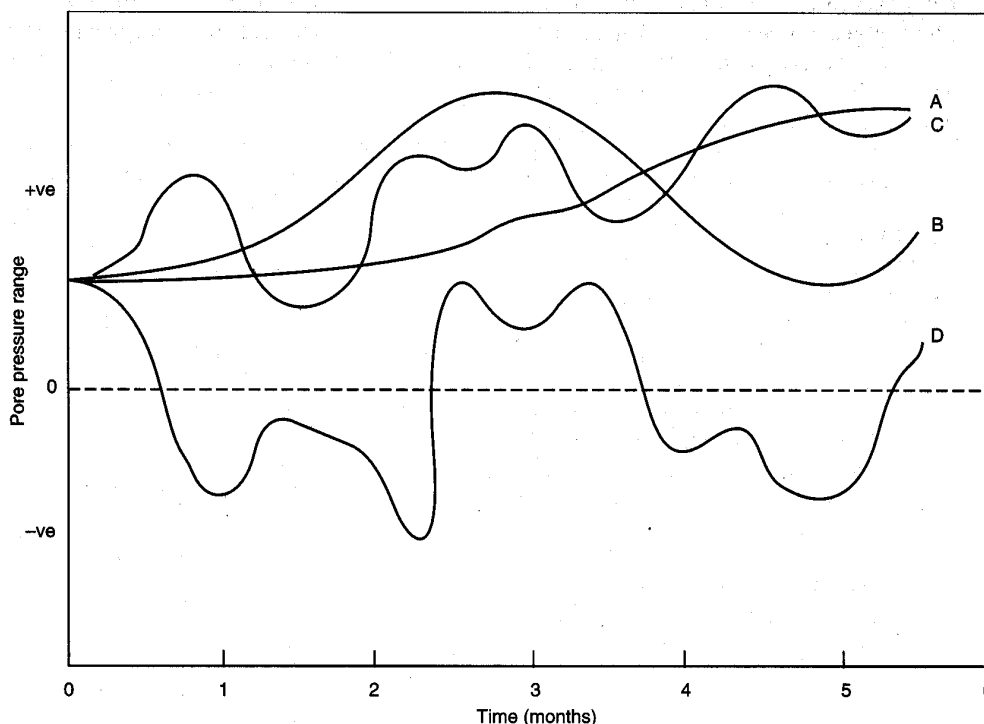

**Figure 11 Four typical piezometer response characteristics**

**Table 4: Summary details of the piezometer responses given in Figure 11**

Groundwater Response	Approximate Average Rate of Change	Pore Pressure Range	Piezometer system
A	1m / month	Positive	Open standpipe system. Low air entry piezometer tip. Manual monitoring (dip meter)
B	1m /week	Positive	Casagrande piezometer, filter design to be calculated from piezometer basic time lag and required shape factor. Consider automatic monitoring - bubbler or acoustic systems
C	1m / day	Positive	Rapid response, low volume factor system required - closed hydraulic or transducer. If always 0 kPa then use low air entry piezometer tip. Use a data logger system to control monitoring cycle and store frequent data
D	1m / day	Positive and negative	Main specifications as C above. Must use a high air entry ceramic to avoid de-airing of the system. For near surface monitoring may consider automatic tensiometer system, see - Instruction 5.2

**CURVE A:** **Little variation in the pore pressure conditions.** Only approximate groundwater location is required. Consider using an open hydraulic stand-pipe system with a low air entry piezometer tip. Manual monitoring (dip metre) can be used. If a large number of piezometers are required and/or installations are in remote locations, consider using automatic systems (e.g. data logger with either a down stand-pipe transducer system, or vibrating wire piezometers).

**CURVE B:** **Fluctuating positive pore pressure conditions.** For most cases a Casagrande stand-pipe piezometer is suitable with either manual or automatic monitoring. For soils with permeabilities that are less than  $1 \times 10^{-9} \text{ms}^{-1}$  consider a low volume system (minimise the internal diameter of the stand-pipe) to avoid a lagged response. The instrument suitability and filter design can be assessed by calculation, see Instruction 4.2.

**CURVE C:** **Rapid changes in positive pore pressures as a response to individual storm events.** To monitor the worst soil pore pressure conditions it is essential to use a low volume

system. Closed hydraulic piezometer systems or vibrating wire piezometers are therefore preferable. Further enhancement in response can be achieved by using a low air entry ceramic, provided the tip always remains saturated. To ensure maximum efficiency it is recommended that an automatic monitoring system is employed.

**CURVE D:** **Rapid pore pressure changes that may be both positive or negative.** This response is typical of that experienced in steep tropical residual soil slopes when piezometer tips are located at shallow depths and within zones where perched water tables develop. It is essential to match equipment to the range and rapidity of change in conditions likely to be experienced. A closed system is preferable to ensure a low volume factor and hence achieve rapid response. The system must be capable of being de-aired in situ and it is necessary to use a high air entry ceramic tip. Automatic monitoring is essential - a transducer based system provides maximum flexibility. Tensiometers should also be installed to provide additional negative pore pressure information, Instruction 5.2.

**Table 5: Summary of Piezometer characteristics**

Type	Range	Response	Deairing	Monitoring	Comments
Open hydraulic (Casagrande) Low air entry tip	Atmospheric pressure to top of standpipe	Slow due to high volume factor of the standpipe. Design filter size to obtain suitable factor F. Response improved by decreasing standpipe diameter	Self de-airing as long as standpipe diameter is >12mm	Manual - dip meter Automatic - Bubbler system Acoustic system Transducer within standpipe	Manual system is cheap, simple and easy to read making it the first choice for the measurement of positive pore water pressures. For reasonable to good response the material permeability should be less than $1 \times 10^{-1} \text{ CMS}^{-1}$ Automatic systems increase the overall flexibility but not its response. In general, suitable for majority of applications unless fast response required.
Closed hydraulic Low air entry tip	Any positive. May be restricted by the head difference between the tip and monitoring sensor	Moderate to rapid depends on the volume factor of the monitoring device	Can be de-aired	Manual - Mercury Manometer Bourdon Gauge Automatic - Pressure transducer (multiple systems require either a number of transducers or a fluid scanning switch)	Only satisfactory if the tip is always saturated. Tip can be installed during construction and hydraulic lines can run in any direction as long as the absolute vertical distance between the tip and sensor is known. Multiple system can be used, however. Separation distance restricted by elevation changes and hydraulic resistance in the tubing. For large separations use electrical system.
Closed hydraulic High air entry	-1 atmosphere to any positive pressure. Same restrictions as above	Similar to above Slight restriction due to lower permeability tip	Can be de-aired	As above	High air entry tip must be used when the material around the tip may become partly unsaturated. This system also capable of measuring suctions. Other considerations are the same as above.
Electrical Transducer located within a high air entry tip	-1 atmosphere to any positive depending on the transducer specification	Rapid	Not insitu without modification	Transducer output is in millivolts which can be manually measured or automatically using a data logger	Transducer/tip can be located at any position and is connected to a data logger using electrical cabling. Large piezometer tip separations (up to 500m) can be achieved using a small amplifier circuit. Electrical system is extremely flexible and adaptable However, it is the most expensive system.

## INSTRUCTION 4.2

### Calculation of the time lag, T, equalisation ratio, E, and intake factor, F, for a piezometer.

**6.6** Closed piezometer systems that employ transducers, for most practical purposes, can be regarded as having an instantaneous response, though response time will be lengthened by long distances between the monitoring device and the piezometer tip.

**6.7** For open systems the piezometer response can be represented by the system time lag, that is the time taken for the system to respond to an external change in pore water pressure. This can be affected by the shape and type of piezometer used, the response of the soil to instrument installation, both the consolidation and swelling of the soil in response to changes in the soil moisture content, and the erosion and/or build up of soil fines in and around the piezometer tip.

**6.8** A number of important concepts need consideration. For any change in external pore pressures there will be an associated response from the piezometer. With an ideal system this will be instantaneous and of the same magnitude as the external change. However, due to the factors described above the response is characteristically delayed and of a smaller magnitude to that in reality. The difference between the measured and actual response introduces the terms **equalisation** and **equalisation ratio**. Equalisation is the matching of the change in external pressure to that recorded in the piezometer. The equalisation ratio is the ratio between the actual change and that recorded in the piezometer. The time taken for flow to or from a piezometer until equalisation (or a desired level of equalisation) is achieved is called the **hydrostatic time lag**. In addition to the hydrostatic time lag there is the **stress adjustment time lag**. This is the time lag introduced into the system as a result of changes in the soil stress conditions both from initial disturbance of the soil from installation and transient consolidation and swelling of the soil with changes in the soil moisture conditions. Stress adjustment time lag is minimised by having a small well point (filter and ceramic) and large volume factor (open system). This is in direct opposition to the requirements to minimise hydrostatic time lag.

**6.9** For tropical residual soils and for circumstances where observations are to be extended over time it is the **hydrostatic time lag that is the dominant factor in controlling the overall system time lag. Emphasis should therefore be placed on maximising the well point and minimising the piezometer volume factor.**

#### Calculation of the time lag of a piezometer system

**6.10** The hydrostatic time lag of a piezometer system can be calculated using the Hvorslev (1951) **basic time lag** function. This formula allows calculation of the lag time

(T), for the equalisation of an initial pressure difference when the original flow rate (q) is maintained, see Figure 12. Given that the flow rate, q, can be calculated by:

$$q = FkH_0 \quad \text{equation 4.1}$$

where

$$\begin{aligned} q &= \text{flow rate (m}^3\text{s}^{-1}\text{)} \\ F &= \text{piezometer shape or intake factor (m)} \\ H_0 &= \text{Hydraulic head at time zero (m)} \end{aligned}$$

and that the volume of the piezometer, V is:

$$V = A.H_0 \quad \text{equation 4.2}$$

where

$$\begin{aligned} V &= \text{piezometer volume (m}^3\text{)} \\ A &= \text{Piezometer cross sectional area (m}^2\text{)} \\ H_0 &= \text{Hydraulic head at time zero (m)} \end{aligned}$$

then the basic time lag, T, can be calculated by:

$$T = V/q = AH_0 / FkH_0 = A/Fk \quad \text{equation 4.3}$$

**6.11** Figure 12a and b illustrate that the basic time lag corresponds to an equalisation ratio of 0.63. Figure 13 summarises a number of basic time lag responses, from which the head changes and equalisation ratios can be calculated for specific time periods.

**6.12** From equation 4.3 it can be seen that piezometer system design should seek to minimise the volume factor, V, and maximise the intake factor, F, to provide monitoring with a minimum time lag.

#### Calculation of the equalisation ratio, E

**6.13** The equalisation ratio of the system, E, is defined by:

$$E = 1 - H/H_0 = 1 - e^{-(t/T)} \quad \text{equation 4.4}$$

where

$$\begin{aligned} H &= \text{Hydraulic head at time t (m)} \\ H_0 &= \text{Hydraulic head at time zero (m)} \\ t &= \text{time interval from the initial change (s)} \\ T &= \text{the basic time lag of the system (s)} \end{aligned}$$

From this equation it can be seen that the equalisation ratio is dependent on the basic time lag of the system.

**6.14** Figure 14 illustrates the effect that different equalisation ratios have on the piezometer response to a particular groundwater change. Two points to note are:

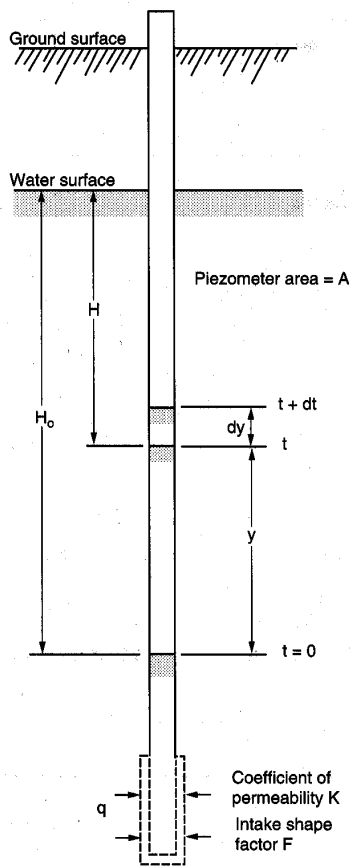

Figure 12a Basic geometry of the Hvorslev (1951) solution to response times of open piezometer systems

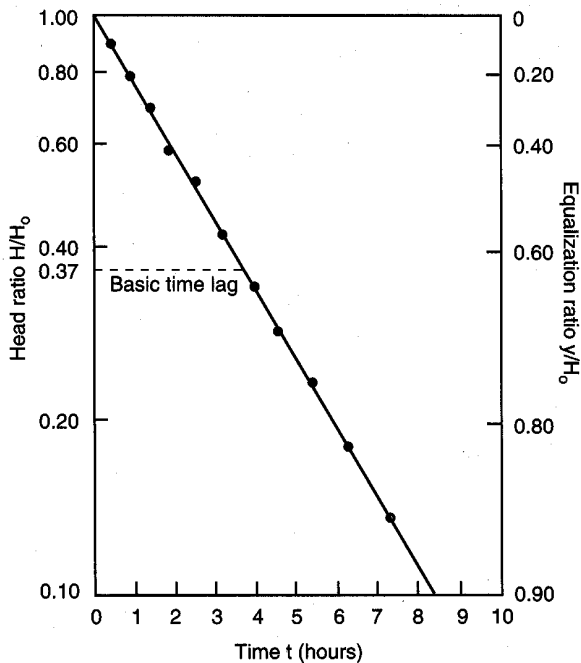

Figure 12b Analytical solution to the Hvorslev (1951) response times

- 1) The **time** of the piezometer peak is determined by the equalisation ratio of the system
- 2) The **magnitude** of the peak is controlled by the equalisation ratio.

6.15 An equalisation ratio of 0.9 can be considered adequate for most practical cases and this corresponds to a time lag of 2.3 x basic time lag:

$$T_{90} = 2.3T \quad \text{equation -1.5}$$

Where

$$T_{90} = \text{Lag time for 90\% equalisation}$$

$$T = \text{Basic lag time of system}$$

#### Calculation of the intake factor, F

6.16 From equation 4.3 it can be seen necessary to calculate the **intake factor** of the piezometer system if calculation of the time lag and equalisation ratio is to be achieved. Figure 15 summarises the equations for calculation of the intake factors for a variety of piezometer constructions (Hvorslev, 1951). For a standard Casagrande type piezometer installation the intake factor, F, is given by:

$$F = \frac{2\pi L}{\ln \left[ \frac{L}{D} + 1 + \sqrt{1 + \left[ \frac{L}{D} \right]^2} \right]} \quad \text{equation 4.6}$$

Where:

L = Length of the piezometer tip (m)

D = Diameter of the piezometer tip (m)

6.17 Subsequent verification of this formula by Brand and Premchitt (1980) suggest the following modification:

$$F = \frac{2.4\pi L}{\ln \left[ 1.2L/D + 1 + \sqrt{1 + \left[ 1.2L/D \right]^2} \right]} \quad \text{equation 4.7}$$

The difference between the two formulas however is small enough to make either procedure appropriate.

#### 6.18 Worked example for the calculation of the basic time lag for a stand-pipe piezometer

Calculate the time lag for a piezometer installation given the following data:

Filter length	=	21 cm
Filter diameter	=	10 cm
Stand-pipe tube diameter	=	1.92cm
Soil permeability	=	$1 \times 10^{-5} \text{cms}^{-1}$

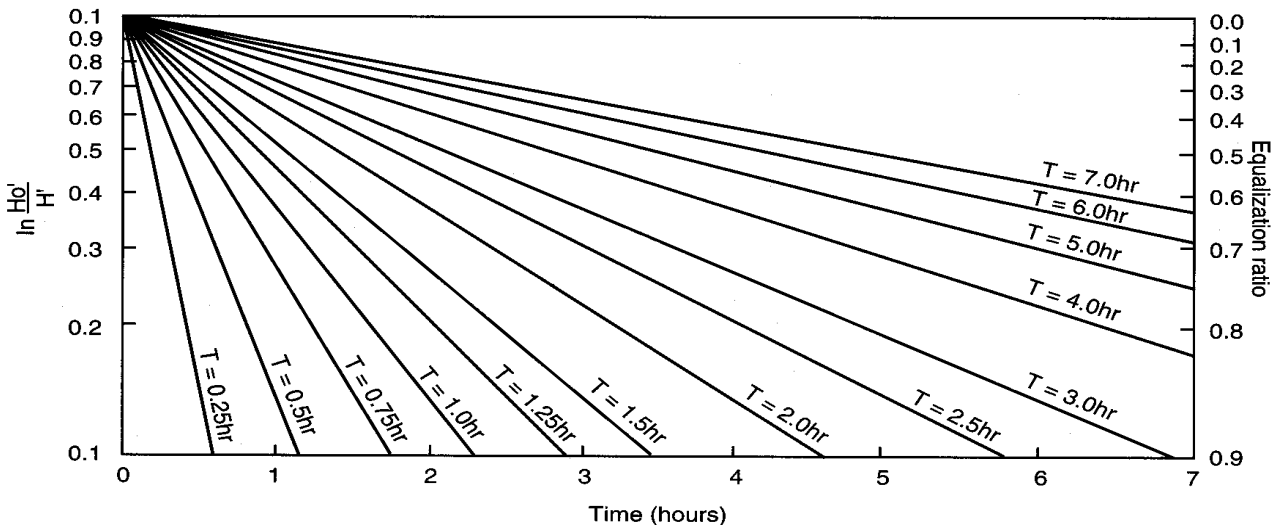

Figure 13 Summary diagram for calculating piezometer basic time lag and equalization ratios

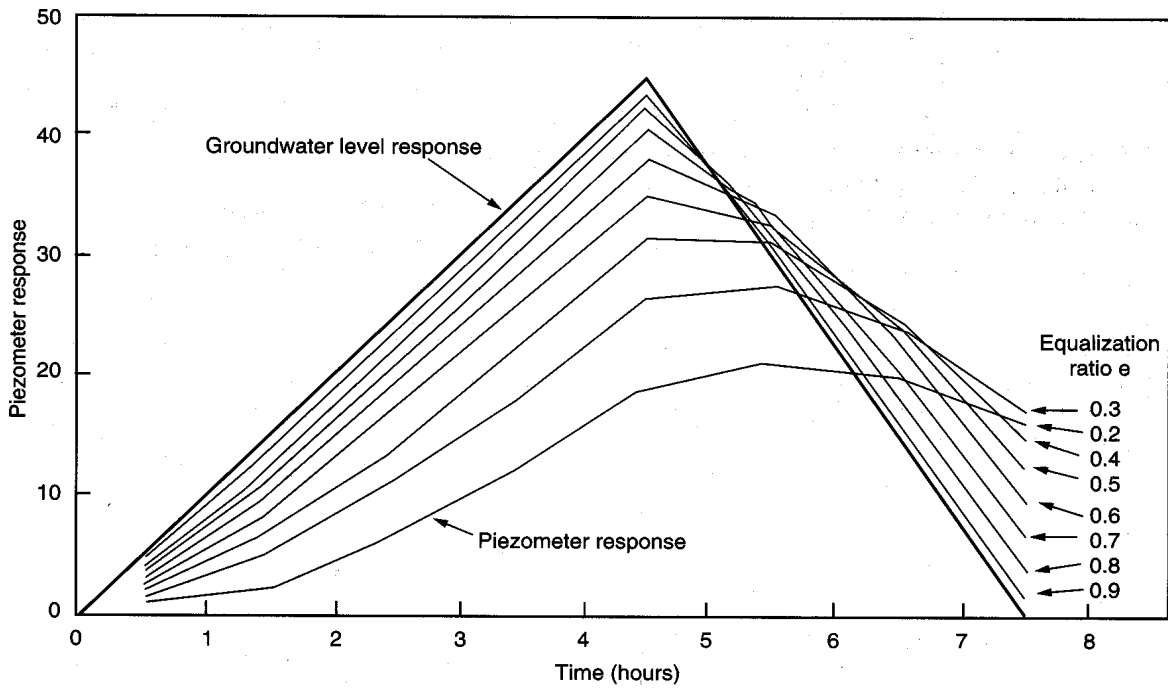

Figure 14 Dampening characteristics of various piezometer specifications

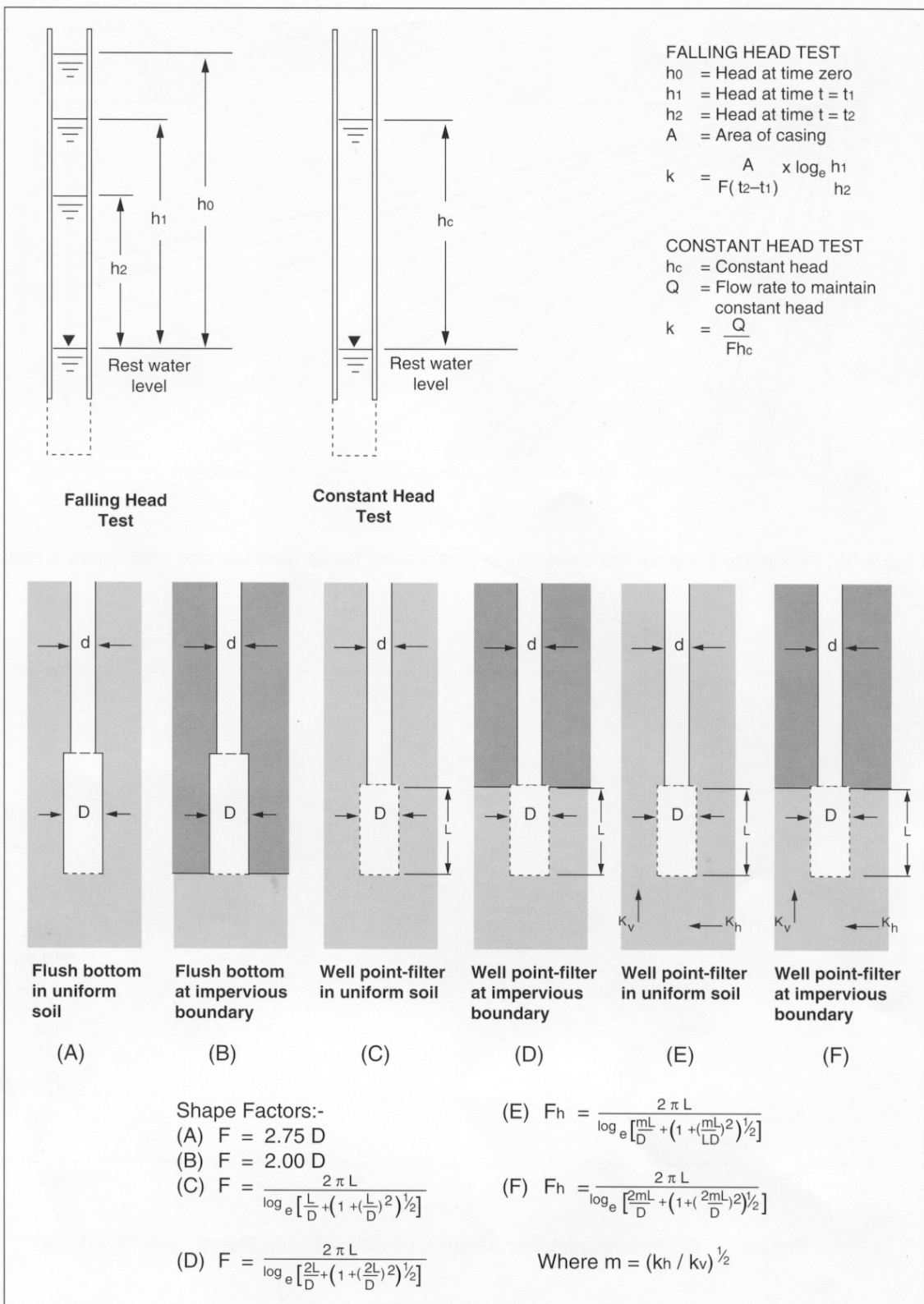

Figure 15 Shape factors (F) for various piezometer constructions according to Hvorslev (1951)

1) Calculate the intake factor for the system using equation 4.6.

Given that:

$$F = \frac{2\pi L}{\ln\left[\frac{L}{D} + 1\sqrt{1 + \left[\frac{L}{D}\right]^2}\right]}$$

$$F = \frac{2\pi \times 21}{\ln\left[\frac{21}{10} + 1\sqrt{1 + \left[\frac{21}{10}\right]^2}\right]}$$

**F = 88.7 (cm)**

2) Calculate the basic time lag of the system using equation 4.3.

Given that:

$$T = \frac{A}{Fk} = \pi(D/2)^2/Fk$$

where:

D = stand-pipe diameter  
= 1.92 cm

T = 3264 seconds  
≈ 0.91 hours

3) Calculate the time lag to monitor 90 % of the actual peak value.

Given that:

$$T_{90} = 2.3T$$

where:

T<sub>90</sub> = Time lag to 90% of peak value  
T = Basic time lag (from above)

then

**T<sub>90</sub> = 2.09 hours**

6.19 Not only can the shape of the piezometer filter affect the intake factor, F, but also the permeability of the ceramic, see Figure 16. Kemp et al (1989) have carried out finite difference modelling of the ceramic/filter/soil system and stress the need to consider a combined filter and ceramic intake factor, F\*. The results of this study provide the following recommendations:

- 1) If the filter and ceramic permeabilities are more than 50 times that of the soil ( $K_f/K_s > 50$  and  $K_c/K_s > 50$ ) then the combined intake factor, F\*, approximates to the Hvorslev intake factor, F, and no correction factor need be applied.

- 2) If the ceramic permeability is less than 50 times that of the soil whilst the filter permeability is greater than 50 times that of the soil ( $K_f/K_s > 50$  and  $K_c/K_s < 50$ ) then the overall system intake factor, F\*, needs to be calculated. This requires the calculation of the intake factor, F (FS), and the ceramic intake factor, F<sub>c</sub>. This allows determination of the influence factor, R or R' (given in Figure 17), which is used to calculate the overall system intake factor, F\*. An example solution is given below.

Given the following conditions determine the overall system intake factor, F\*

Piezometer and soil properties:

Filter length and diameter	100 x 10 cm
Ceramic tip dimensions	15x3.3cm (internal) and 4.85cm (external diameter)
Soil and tip permeability	$1 \times 10^{-4}$ and $1 \times 10^{-3} \text{cms}^{-1}$

By using equation 4.6 the intake factor for the soil/filter, F<sub>s</sub>, can be calculated:

$$F_s = \frac{2\pi \cdot 100}{\ln\left[\frac{100}{10} + 1\sqrt{1 + \left[\frac{100}{10}\right]^2}\right]}$$

**F<sub>s</sub> = 209**

The intake factor, F<sub>c</sub>, for the ceramic can be calculated from the following equation:

$$F_c = \frac{2\pi l}{\ln[d_1/d_2]}$$

**equation 4.7**

where

l	=	length of the ceramic
d <sub>1</sub>	=	internal diameter of the ceramic
d <sub>2</sub>	=	external diameter of the ceramic

hence:

$$F_c = \frac{2\pi \cdot 15}{\ln[4.85/3.3]}$$

**F<sub>c</sub> = 245**

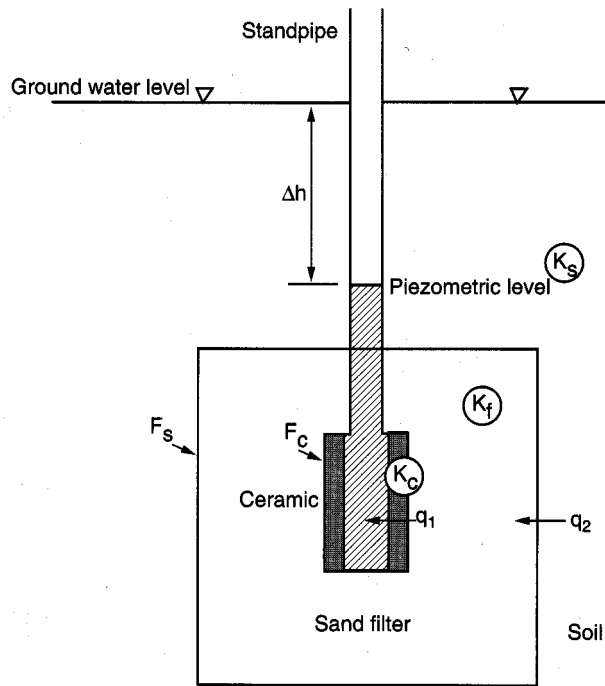

Figure 16 Schematic representation of the piezometer filter zone

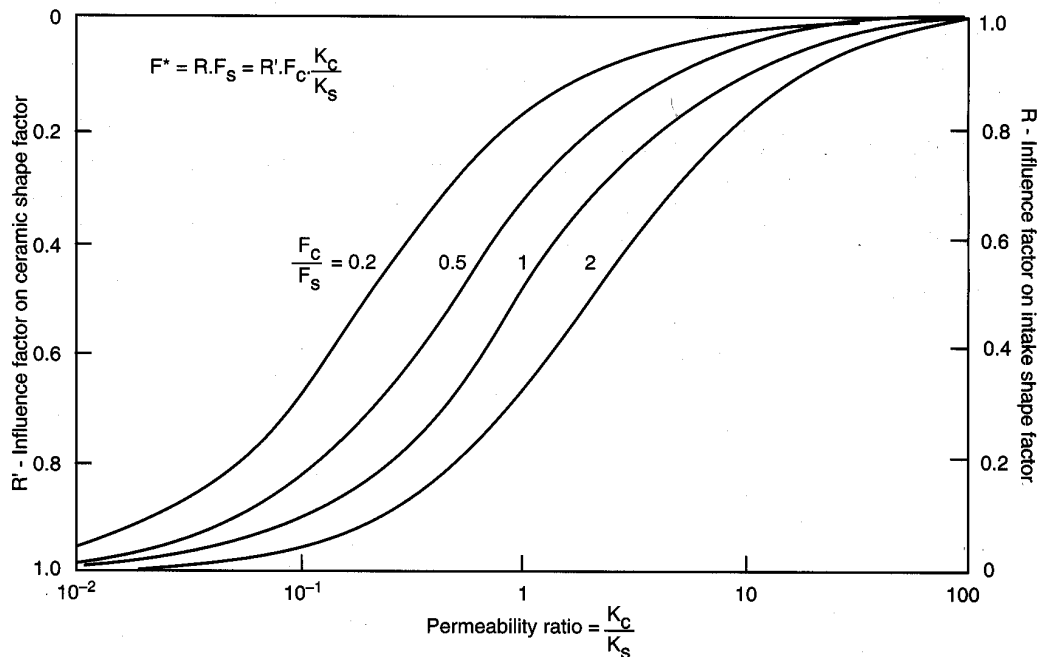

Figure 17 Calculation of the influence factor on intake shape factor

Using the chart in Figure 17 and locating the positions for  $F_s/F_c = 0.855$  and  $K_c/K_s = 10$ , a value for R of 0.90 can be determined. The intake factor for the system therefore can be calculated using the formula:

$$F^* = R.F_s \quad \text{equation 4.9}$$

to give an overall intake factor value:

$$F^* = 192$$

- 3) *If the ceramic and filter permeabilities are both less than 50 times that of the soil ( $K_f/K_s < 50$  and  $K_c/K_s < 50$ ) then the design of the entire piezometer system can only be accurately determined by using the finite element modelling procedure outlined in Kemp et al (1989).*

**Solutions which ignore the effect of the ceramic filter will significantly over-estimate the overall piezometer shape factor,  $F^*$ , thus underestimating the time lag of the system.**

### INSTRUCTION 4.3:

#### Choice of procedures available for improving the response characteristics of piezometers; (if appropriate)

**6.20** The basic procedure for response improvements is to adopt systems or improvements that reduce the basic time lag,  $T_i$ , of the system. This can be achieved by either reducing the volume factor or increasing the intake factor,  $F$  (or  $F^*$ ). Methods to achieve this for open stand-pipe piezometers are:

- 1) Reduction of the volume factor by decreasing the stand-pipe diameter. For example, a reduction from 19 cm to 14 cm will halve the basic time lag of a piezometer. Care must be taken however as diameters less than 121mm prevent de-airing, so should only be used in ground that is permanently saturated.
- 2) Increasing the filter intake factor,  $F$ , by increasing the dimensions of the filter.
- 3) Conversion of an open hydraulic system to a closed system by inserting a pressure transducer at the tip and sealing the tube using an inflatable packer (see Figure 18)

For closed hydraulic systems there are a number of methods available to improve the response characteristics:

- 1) Reduction of the monitoring instrument volume factor by adopting a lower volume monitoring procedure, e.g. changing from a manometer or bourdon gauge to a pressure transducer.
- 2) Increasing the system stiffness by a reduction in the length of tubing by locating the sensor as close as possible to the tip.

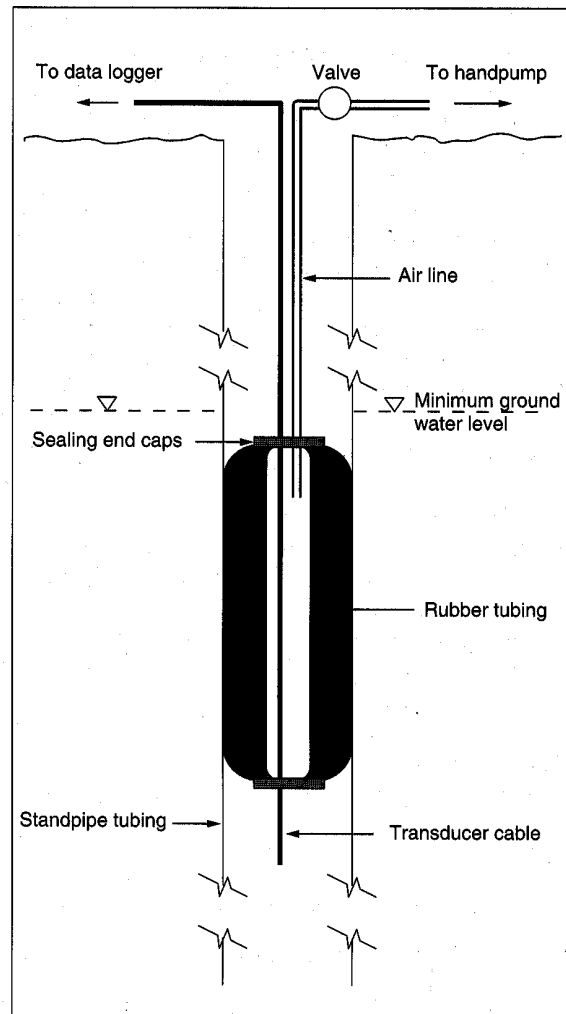

**Figure 18** Inflatable packer used for converting an open standpipe piezometer to a closed piezometer system

- 3) A small improvement can be gained by increasing the intake factor. If the tip is always saturated then a low air entry tip can be specified.

**6.21** Of the number of methods available to improve piezometer performance, that which is most effective is the change of system itself. In particular, the change from open to closed system gives by far the greatest improvement in response time and equalisation ratio.

### INSTRUCTION 4.4

#### Selection of the monitoring and data recording equipment for the piezometer system.

**6.22** Two approaches to piezometer monitoring are possible, the choice of either manual or automatic systems.

### 1) Manual

With manual monitoring data acquisition, and hence data resolution, is totally dependent on the number of site visits. It is therefore possible to miss the worst conditions if rapid temporal changes occur.

Open stand-pipe piezometers can be manually read using a dip meter, whilst worst conditions can be approximated using a Halcrow bucket system. This consists of a series of cups lowered down a stand-pipe to known depths. On returning to the site, the uppermost full cup locates the approximate position of the highest recorded water level. All manual operations require manual data transfer prior to processing. For multiple systems the work load involved in this process becomes significant.

### 2) Automatic (see also Instruction 6)

Automatic monitoring systems allow a large amount of data to be accumulated between site visits. In addition such systems usually offer an operator controlled reading frequency, providing far greater resolution of monitoring. Consequently, such systems are advisable when rapid fluctuations in groundwater are likely if worst conditions are to be identified. With the importance of system reliability there has been a move to the use of solid state electronic data logging facilities. When considering such systems there are a number of points that should be addressed:

- (i) That on site monitoring devices are compatible with the logging facility.

- (ii) The storage space available in the data logger is matched to the number of instruments and monitoring resolution. The maximum period of time between site visits should be calculated so that no data is lost due to lack of system memory.
- (iii) The system demand on power should be minimised (low energy systems are preferred) so that the system can run unattended for suitable lengths of time without battery failure.

**6.23** In general, the advantages offered by an automatic monitoring facility in terms of increased data resolution and response times (in the case of closed transducer based systems) would advocate their use for conditions in the tropics, especially for the assessment of worst case conditions for input to slope stability assessment. Such systems are however expensive. For short term monitoring projects a manually read piezometer system is the only economical choice. However, if monitoring of groundwater is to be made over a period of time then the high initial cost of such equipment and low running cost may be balanced out by the high running cost of frequent manual readings (labour cost), see Figure 19. In all cases it is necessary to calculate the difference in overall cost between manual or automatic based systems and balance that against the data quality demands.

**6.24** When installing any equipment, care must be taken to ensure system security - both against theft and vandalism. This is especially the case for high cost automatic based systems.

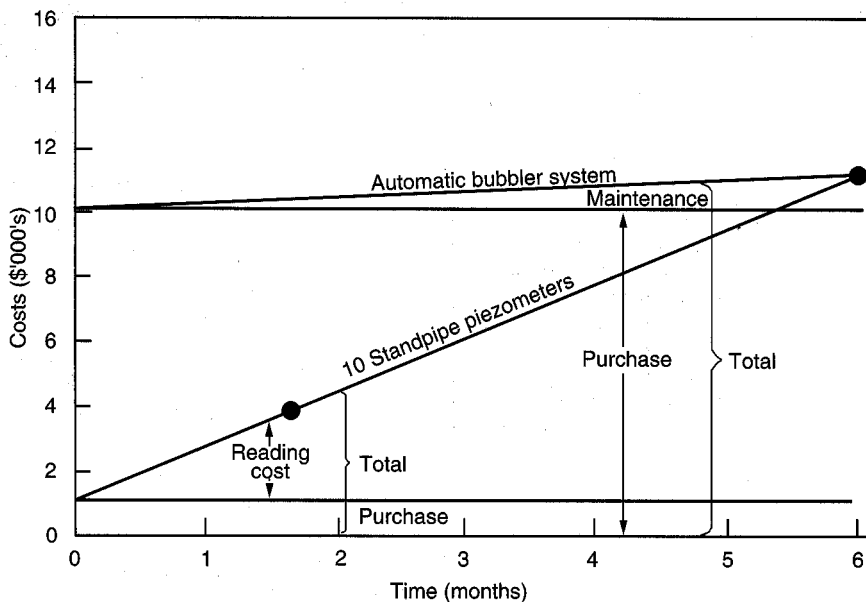

**Figure 19** Comparative illustrative costs of bubbler piezometer system and manual piezometer (read daily)

## SUMMARY DECISION STRUCTURE FOR INSTRUCTION 4

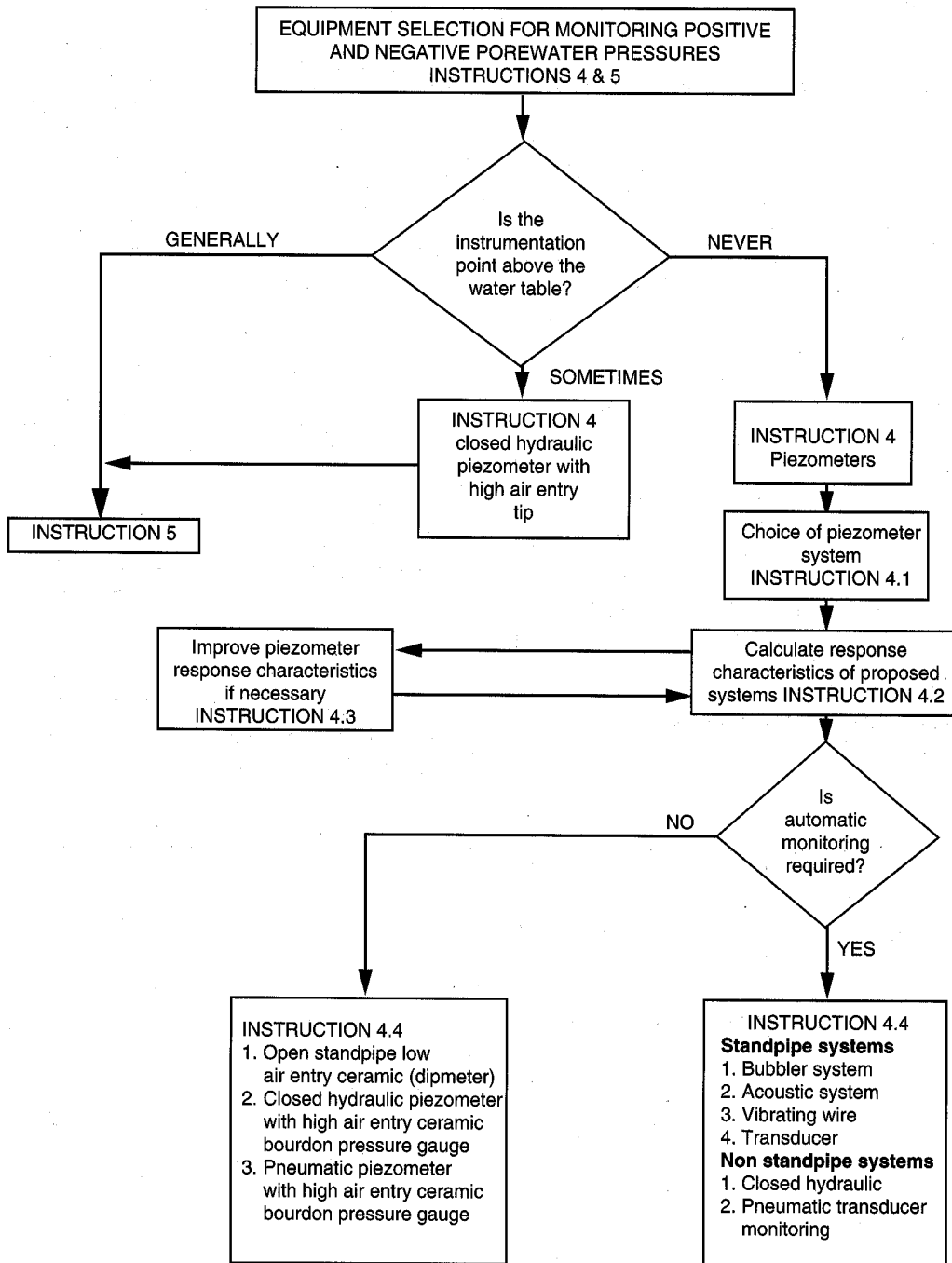

## 7. INSTRUCTION 5

### INSTRUCTIONS FOR THE MEASUREMENT OF SOIL SUCTIONS

7.1 Due to the high evaporation rates, steep slope gradients and often low natural groundwater levels experienced in the tropics, significant suctions may develop beneath the soil surface. Many studies have shown that for a large number of slopes soil water suctions may persist throughout major storm events. Back analysis and monitoring of failed slopes (especially in Hong Kong) have shown the importance of suction in maintaining a factor of safety greater than 1. This has resulted in the development of stability analysis procedures which incorporate the beneficial aspect of soil suction in the assessment and monitoring to provide the input data for such calculations.

## INSTRUCTION 5.1

### Selection of instrument type based on monitoring range.

7.2 The selection procedure for establishing the most suitable equipment for monitoring soil water suction is outlined in Figure 20. An important distinction between the type of equipment is in the form of suction measurements. For suctions **less than 80 kPa** *direct* field measurements can be undertaken with a water to water (instruments to soil) interface. Tensiometer systems are used for the direct measurements of soil suctions. For suctions **greater than 80 kPa** *indirect* measurements systems are required. At such suctions water in tensiometer based systems cavitates leading to unreliable readings. Normally suctions greater than 80 kPa would not be included in the analysis of slope stability but if it is necessary to assess such suctions an indirect MCS system (Instruction 5.5) is suggested.

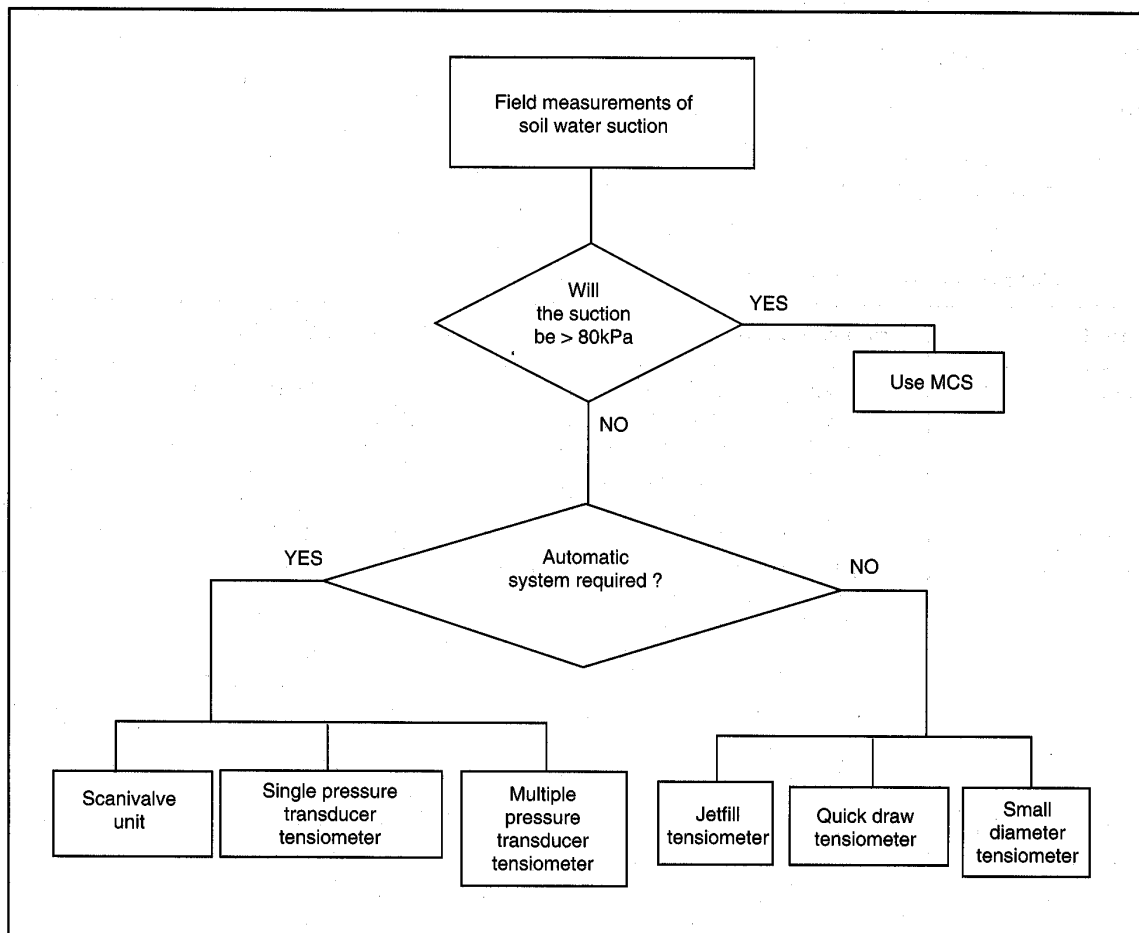

Figure 20 Instrument selection for soil water suction monitoring

7.3 The initial assessment of the suction range that exists can be provided by using a quick draw tensiometer though this is limited to depths no greater than 50 cm below ground level.

## INSTRUCTION 5.2:

### Selection of tensiometer equipment

7.4 Tensiometers are water filled instruments with a high air entry ceramic tip. The instrument is inserted into a small bored hole in the ground (usually 21 mm diameter). The soil matrix suction is measured directly by obtaining a water equilibrium across the tip between the soil water and the water confined in the instrument. Since soluble salts are free to pass through the membrane, the measurement is free from any osmotic effects. The soil water suction is represented by the water tension within the tensiometer and may be measured using a manometer, pressure gauge or a transducer. The actual soil water tension at the instrument tip is the recorded value on the measuring device less the vertical distance from the sensor (e.g. transducer diaphragm) to the tensiometer ceramic mid point:

$$\text{Total suction (mH}_2\text{O)} = \text{Recorded suction (mH}_2\text{O)} - z$$

where:

$z$  = the vertical distance from transducer to the tensiometer ceramic mid point (m)

7.5 In the event of positive pore water pressures developing, then the tensiometer acts as a closed hydraulic piezometer.

7.6 Manual tensiometers are particularly useful as they are relatively cheap, reliable, robust and easy to install. Examples are detailed to Table 6 which include;

- 1) Jetfill tensiometers - Figure 21
- 2) Quick draw tensiometers - Figure 22
- 3) Small diameter tensiometers - Figure 23

7.7 In addition to manual tensiometers there are a number of automatic versions, which have either the sensor central to a number of instruments (Scanivalve system) or at the instrument location (transducer system). Automatic systems are considered in Table 7 and include

- 1) Scanivalve system - Figure 24 and Figure 25
- 2) Single pressure transducer tensiometer - Figure 26
- 3) Multiple transducer system (Anderson et al, 1990)

Consult Figure 20 and Tables 6 and 7 to determine the most suitable system for the given application.

**Table 6: Manual tensiometer systems**

Type	Principal Use	Equipment details
Jetfill	Soil suction (<80kPa) field studies. Typical operating depth, 0-2m. Useful in extending the range and scope of automatic systems.	Simple, cheap robust and reliable. Maximum installation 4 metres. Install using hand auger, tip must fit snugly into a 21.5mm diameter hole. On-site de-airing.
Quick-draw	Rapid reconnaissance of near surface suctions (<50cm). Useful in establishing preferable instrument locations as well as obtaining soil water conditions, while conducting other field tests.	Maximum installation depth (<50cm). Extremely portable and has a fast equilibrium time with soil conditions, enabling many readings to be taken. In soft soils instrument can be pushed straight into the ground. For firmer soils use manufacturer's push-in auger.
Small diameter tensiometer	Similar as the jetfill but with additional flexibility of installation during construction.	Same principle as the two above but connects the instrument tip to the pressure gauge using flexible tubing, so can be installed during ground preparation.

**Table 7: Automatic Tensiometers**

Type	Principal Use	Equipment details
Scanivalve system	<p>Suitable for detailed soil suction studies radiating profile and spatial variations within a localized area, e.g. establishing the effective stress conditions during storm events. Operational depths up to 4m also will monitor positive pressure conditions.</p>	<p>A number of ceramic tips are connected via plastic tubing to a fluid scanning switch. In turn, each tensiometer tip is linked hydraulically to a pressure transducer. The system requires a data logger to activate the timing of the scanivalve switching and for data recording. This system is limited in range by the elevation of the tip relative to the transducer. Also any faults in the switching mechanism or transducer will affect all the readings. The scanivalve system has proved to be less reliable than fully electrical alternatives.</p>
Single pressure transducer tensiometer	<p>Specialized electronic instrument designed for automatic data logging. Suitable where a small number required for specific locality monitoring, or where spatial influence is small.</p>	<p>This system locates the transducer within the same instrument as the tensiometer tip. The tensiometer may be monitored using a single station data logger or linked to another multichannel data logger. This system can become expensive if a number of locations need to be monitored.</p>
Multiple transducer system	<p>Use is the same as for the scanivalve system, additional advantage that spatial location of instruments less critical. Suitable for detailed geotechnical studies requiring information about the near surface (0-2m depth) soil water conditions.</p>	<p>By modifying a jetfill to accept both a bourdon gauge and a pressure transducer (using a 'y' piece) a simple flexible system can be constructed. This system is fully interchangeable and does not have any elevation considerations. Instrument separation of up to 500m can be achieved using a simple amplifier circuit. This system may be integrated into existing data logger systems.</p>

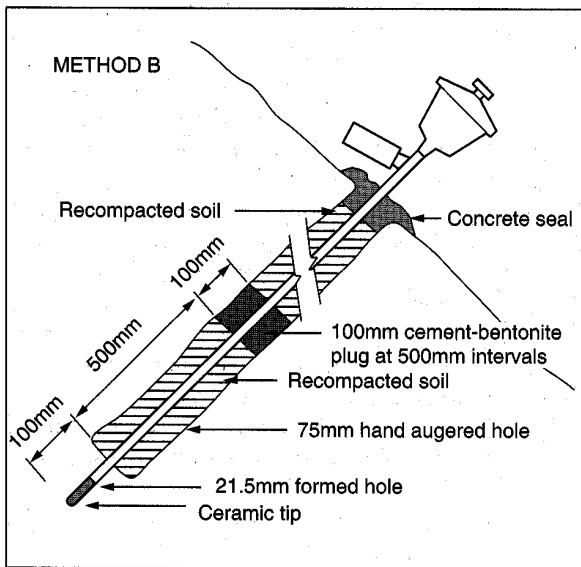
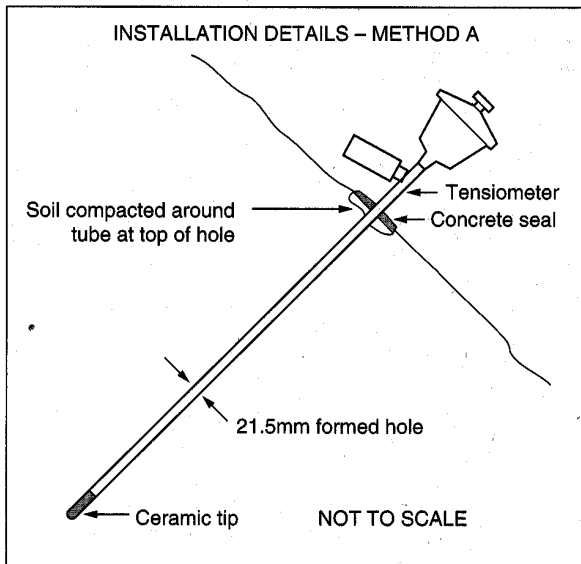

Figure 21 Jetfill tensiometers and example installations (after McFarlane, 1981)

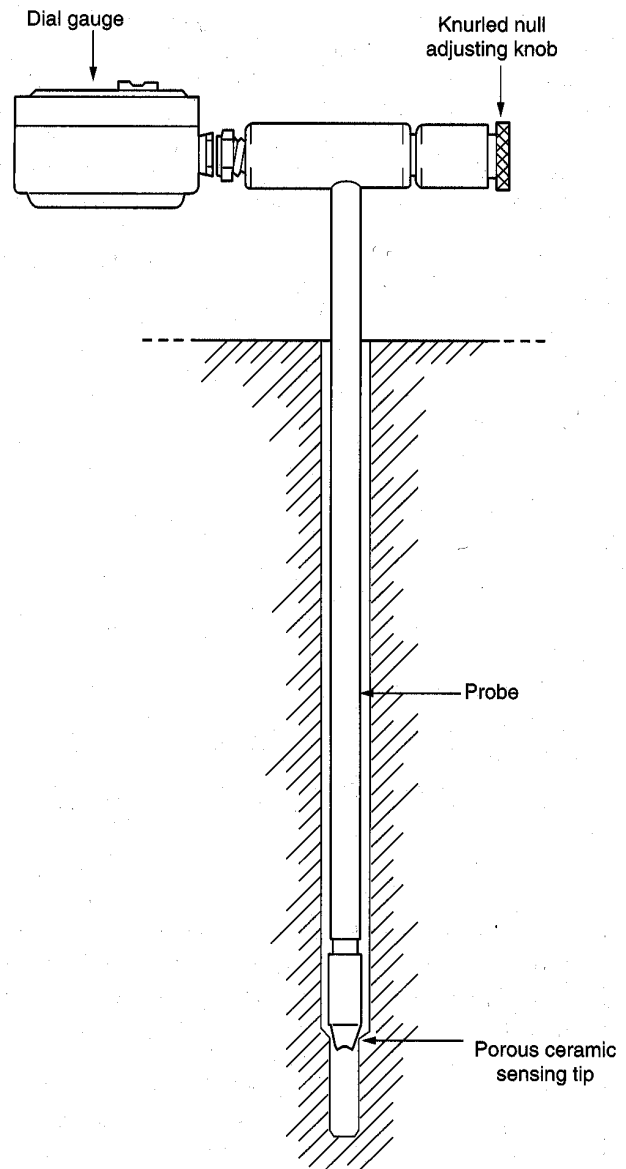

Figure 22 'Quick draw' tensiometer

### INSTRUCTION 5.3

#### Tensiometer response characteristics

7.8 The theory of tensiometer response is in general equivalent to that of piezometer systems in that there are two main considerations:

- 1) the intake properties of the instrument
- 2) the volume factor of the instrument.

7.9 In practice the calculation of tensiometer response times is not necessary as the volume factor is sufficiently low to give rapid equalisation times. The quick draw

tensiometer has a very rapid response time, being only a few minutes. Figure 27 illustrates the quick draw response characteristics to three suctions in which 90 % of the equalisation occurs within two minutes.

7.10 With transducer systems better response characteristics can be achieved, especially when the transducer is located at the instrument or sensor. The response of the scanivalve system, though transducer based, may be slightly restricted by the length (and hence 'stiffness') of the hydraulic line between the tip and the scanivalve.

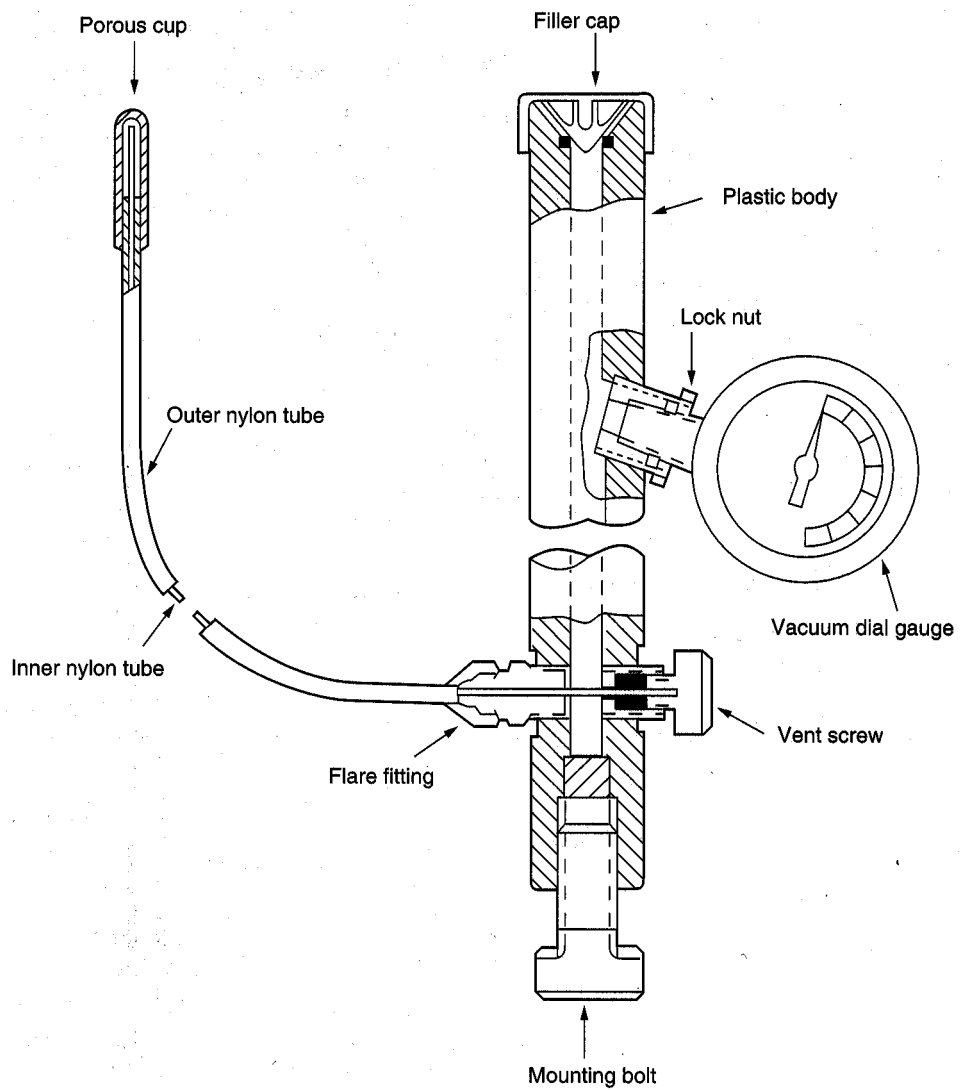

**Figure 23 Small diameter (8mm) tensiometer**

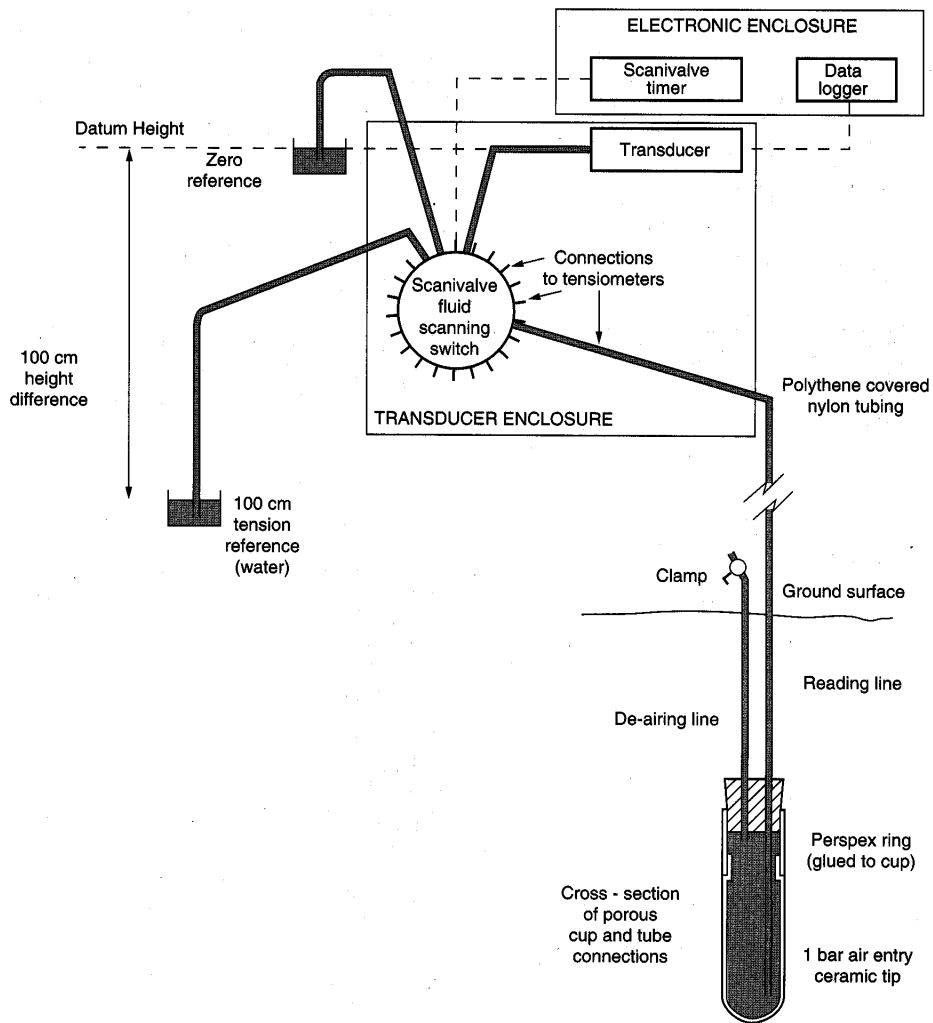
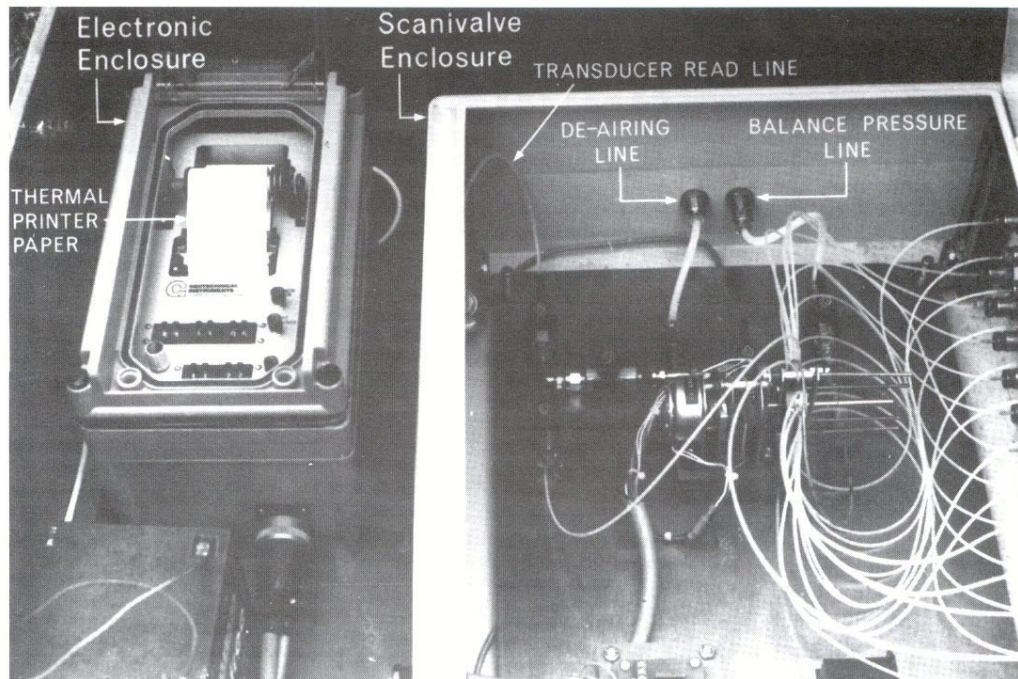

Figure 24 Automatic scanivalve tensiometer system



**Figure 25 Redesigned tensiometer - scanivalve system employing microprocessor control unit (after Anderson and Kneale, 1987)**

#### **INSTRUCTION 5.4**

##### **Tensiometer installation, monitoring and maintenance**

**7.11** When installing tensiometers it is critical that the ceramic tip forms a tight seal with the soil medium so that the water within the instrument is in contact with the soil water. In general, jetfill tensiometers are inserted in hand augured holes (0-2 metres deep). For deep installations the instruments can be inserted laterally from downslope dug caissons. In the case of the scanivalve system, where the tips are attached to flexible tubing, the tips may be installed by auguring or during actual slope construction.

**7.12** Before installation it is advisable to de-air the tips by either boiling in water or by applying a large suction to the tip while in de-aired water. The tip should be lowered to the base of the hole taking care not to scratch the ceramic on stony material. Slight initial back saturation will speed up the sealing of the hole around the tip.

**7.13** If the range and value of soil suctions maintained during and after storm events are to be assessed then an automatic form of monitoring is required. Consider using an electrical transducer based system as this offers the greatest flexibility. Care must be taken in siting the transducer in scanivalve based systems as the difference in elevation between the sensor and tensiometer tip can cause cavitation of the instrument water.

#### **INSTRUCTION 5.5:**

##### **The measurement of suctions greater than 80 kPa**

**7.14** Suctions exceeding 80 kPa would not in practise be used in stability analyses. It is however useful to outline the MCS system for monitoring soil suctions. The MCS equipment consists of a porous block of low heat conductance which is inserted into the ground. By applying a heat source at a point centred within the block and measuring the temperature rise (heat dissipation) a value for the water content can be obtained.

**7.15** The effectiveness of this system is in its ability to measure suctions greater than 80 kPa though the instrument is limited by its response time and calibration needs. Instrument sensitivity in the 0 - 100 kPa range is approximately  $\pm 6$  kPa, see Figure 28. For suctions above 200 kPa, however, the sensor results are open to question.

**7.16** Although the system allows the measurement of soil suctions in the 0 - 200kPa range it is limited by the time required to obtain a stable reading and also dependent on the absorption or desorption cycle of the soil, Figure 29. Typical response times are in the order of 160 hours making it unsuitable for transient conditions. In addition care must be taken during instrument installation as entrapped air can result in considerable measurement errors.

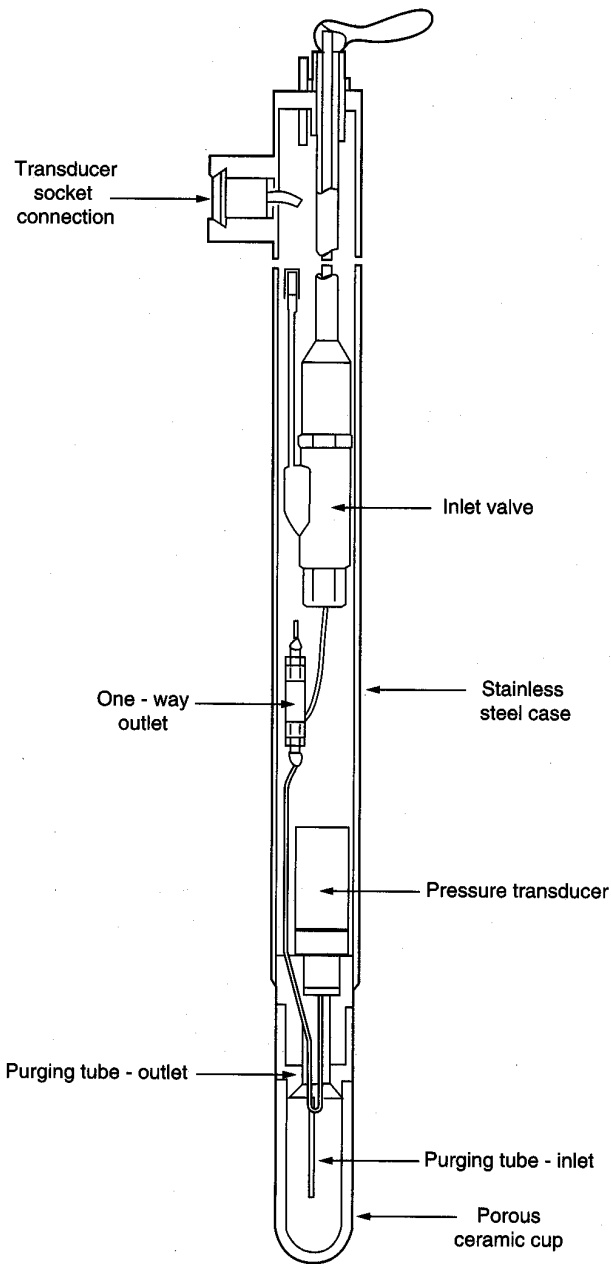

Figure 26 Individual pressure transducer system

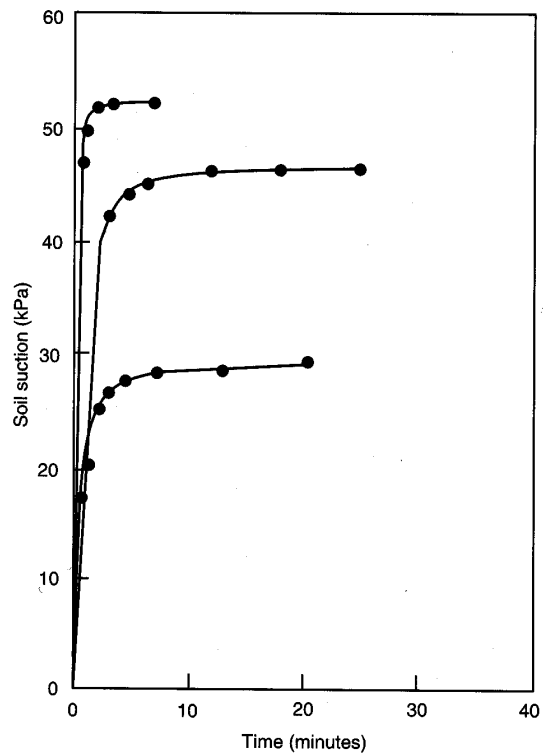

Figure 27 Response times of the 'quick draw' tensiometer (after Sweeney, 1982)

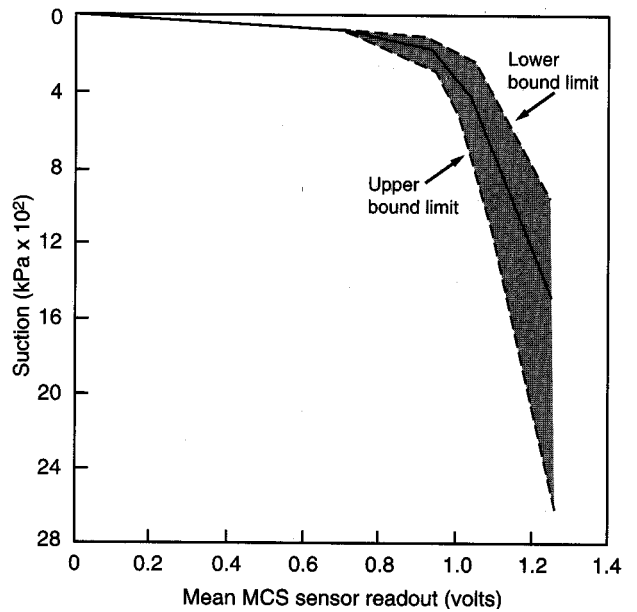
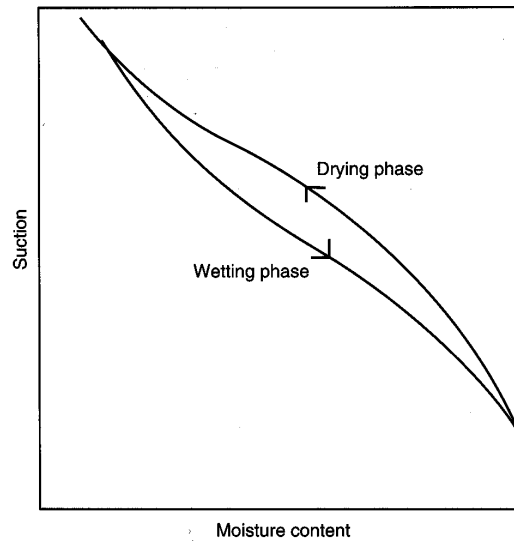
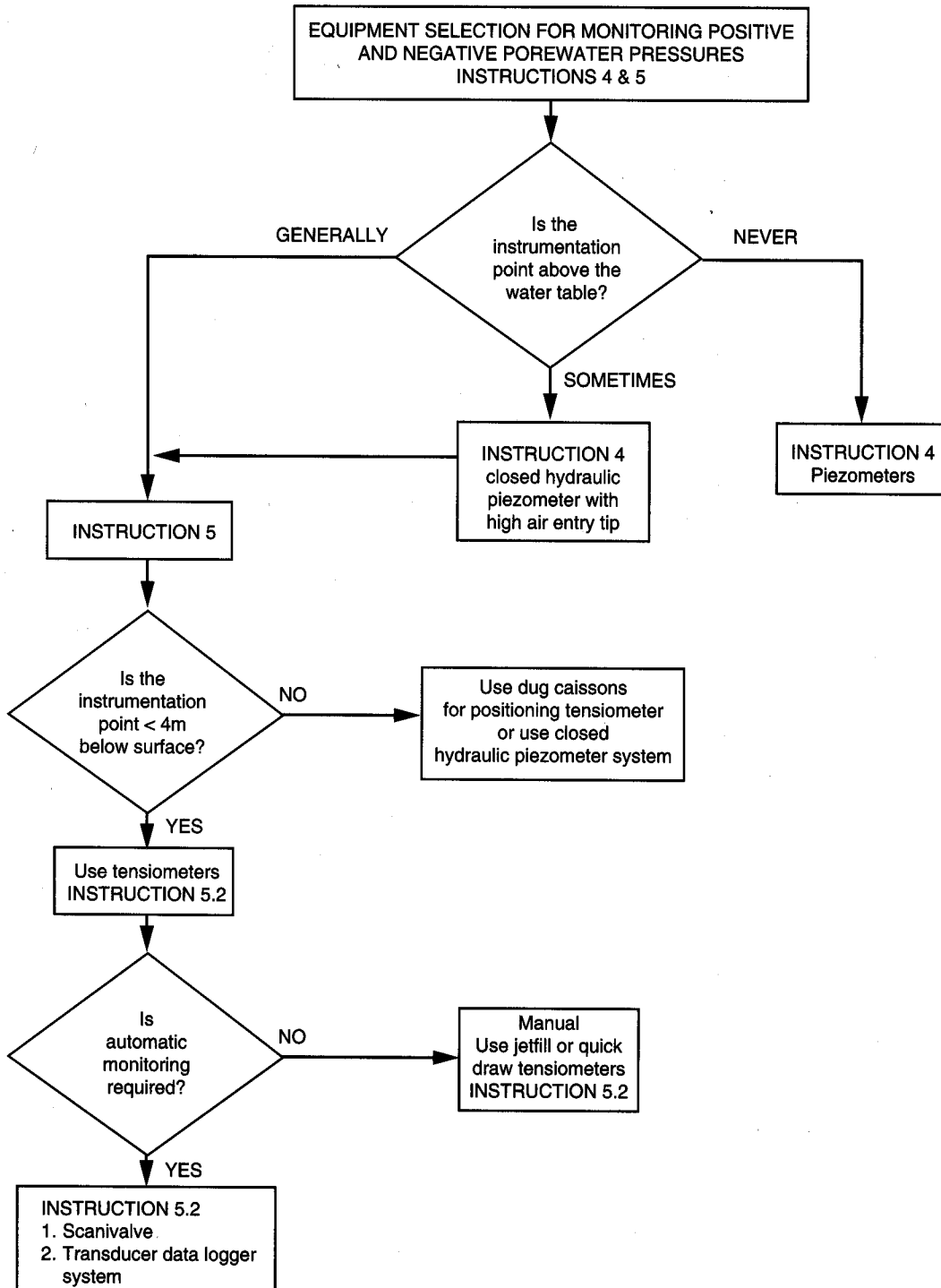

Figure 28 MCS sensor suction - output response (after Lee, 1983)



**Figure 29** Hysteresis in the suction moisture content relationship

**SUMMARY DECISION STRUCTURE  
FOR INSTRUCTION 5**



## 8. INSTRUCTION 6

### INSTRUCTIONS CONCERNING DATA LOGGER SYSTEMS

8.1 Data logger systems enable a number of individual instruments to be monitored remotely. Such systems may be used in conjunction with both negative and positive pore pressure monitoring equipment, though some systems are

equipment specific (e.g. acoustic piezometer system). The main purpose for opting for a data logger is for data handling (enabling frequent readings), data storage (reducing the frequency of site visits) and data transfer from the field to the office. Figure 30 illustrates the components of a data logger system and the interrelationships between field monitoring and office processing of data. An example of a complete data logger system is the bubbler system illustrated in Figure 31.

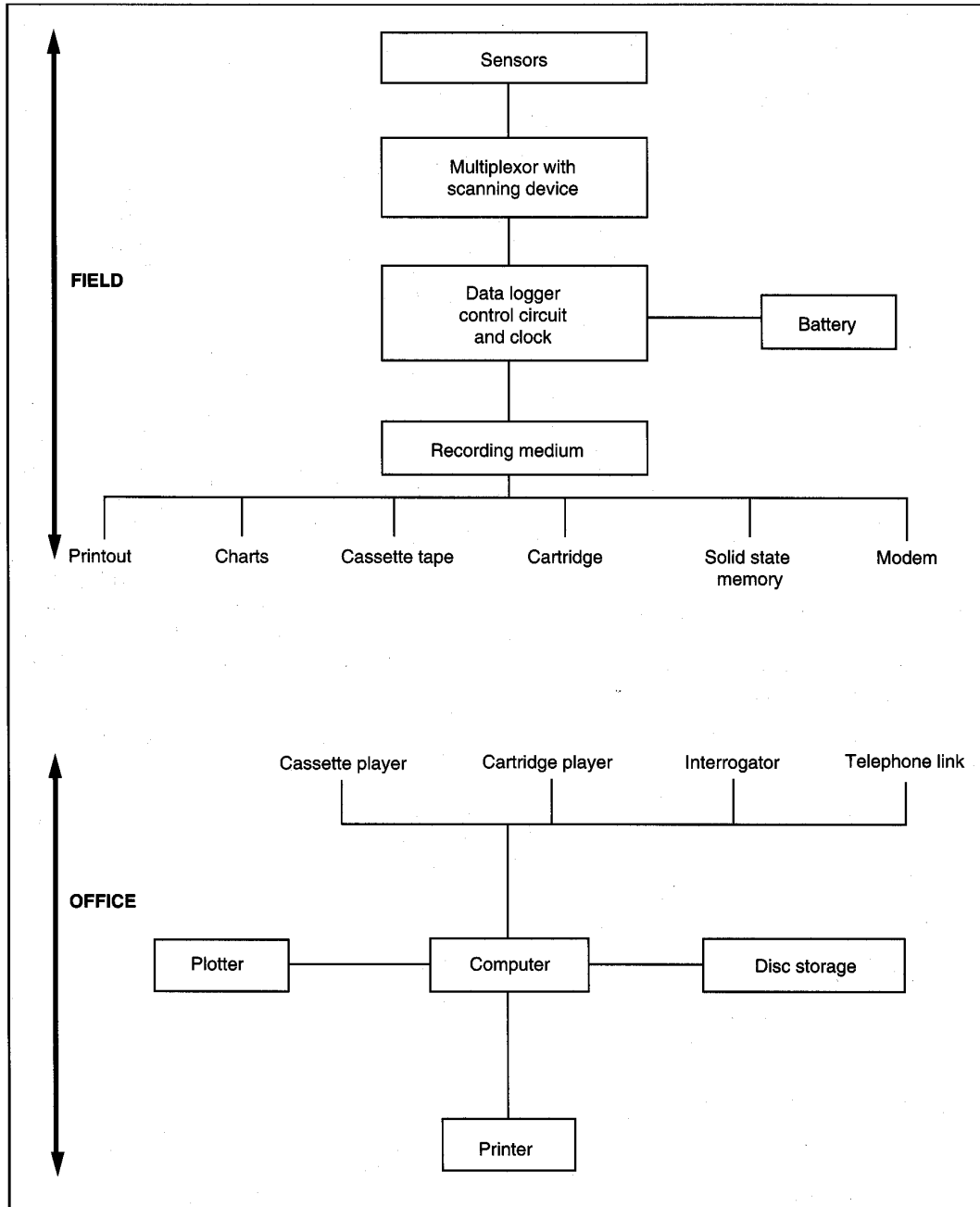
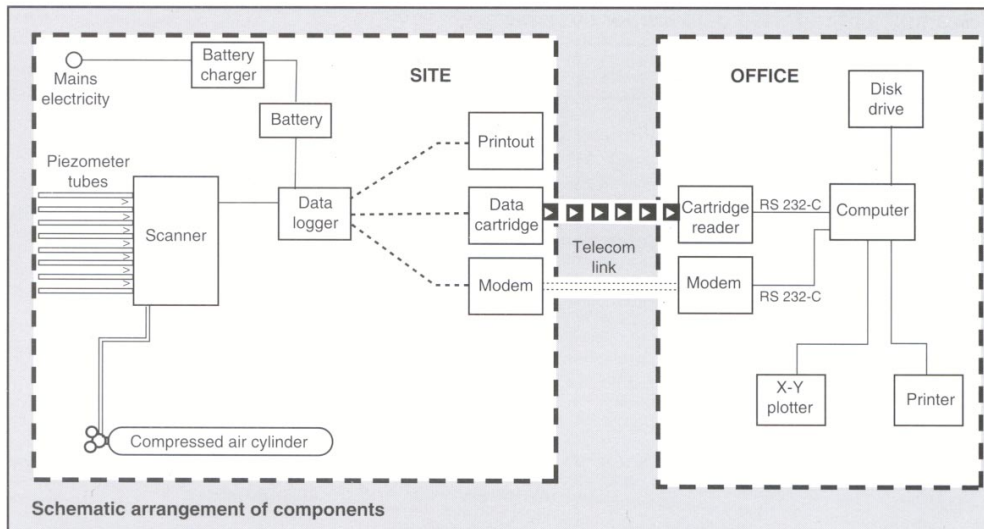

Figure 30 Field and office components of data logger systems



**Figure 31 Bubbler data logger system**

**8.2** Central to the design of modern data loggers is the use of solid state electronics and electrical digital signals. Such systems have proved to be reliable and flexible. Key areas for consideration relate to the system flexibility, compatibility (field to office) and reliability. These must be compared with system cost, value of the data and the length of monitoring before selection can be made of the most appropriate system.

**8.3** Data logging systems allow on site recording of information and so are specifically associated with automatic systems. If the frequency of data gathering is high or the location of the monitoring area remote then the use of a data logger should be considered. The decision should be made by evaluating the cost of *getting* the data against the *value* of the data.

**INSTRUCTION 6.1:**

**Selection of the data logger system**

**8.4** Two approaches can be adopted to the selection of data logging systems: either the selection of an 'off the shelf' complete system or the construction of a system from individual components. Details of a number of systems that have previously been used are given in Table 8.

**8.5** In general, the systems that rely more on electrical than mechanical components prove the most reliable. However, fully automatic electrical systems can allow equipment failure to go undetected for some time until data is processed and so it is recommended that some form of manual monitoring is also available for on site system operational verification. For data logger based systems care must be taken not to corrupt data in storage and to ensure a sufficient data back-up before information is erased from the data logger memory.

**INSTRUCTION 6.2:**

**Choice of sensor**

**8.6** The choice of sensor is largely controlled by the monitoring instrument and the parameters of interest (for example thermocouples for temperature, transducers for pressure, and potentiometers for displacements). The signals from the sensors can be transmitted to a central multiplexor linked to a data logger. In most cases it is more convenient to have the sensor instrument specific, so that any malfunction will affect only one set of readings. If retrieval of the sensor is desirable then sensor location is important (i.e. at the surface or central to the data logger).

**8.7** The sensor chosen should operate throughout the monitoring range and be sensitive enough to that overloading of the sensor does not occur or that the length of cables between instrument and sensor does not affect instrument calibration.

**INSTRUCTION 6.3:**

**Transducer selection**

**8.8** Transducers provide a useful sensor for monitoring piezometric and tensiometric pressures. When choosing the type of transducer to be employed it is necessary to consider:

- 1) the working range (e.g.  $0 \pm 2$  bar)
- 2) signal output (in relation to cable length and hence signal loss; data logging compatibility)
- 3) transducer type

**Table 8: Examples of reported data logger systems**

Author	System
1. Burt (1978), Anderson and Kneale (1987)	Automatic Scanivalve for a tensiometer system
2. Jones et al. (1984)	Cheap data logger shown operating a stage recorder
recorder and tipping bucket raingauge	
3. Bosworth (1985)	Tipping bucket recommendation
4. Anderson and Kneale (1987)	Piezometer bubbler system (Geotechnical instruments)
5. Anderson and Kneale (1987)	Acoustic depth monitoring system
6. Durham et al. (1986)	Digital pulse train data logger system for piezometers, water sampler and tipping bucket
7. Anderson et al. (1990)	Combined automatic tensiometer piezometer system

**8.9** Differences between transducers relate to the pressure conditions on the reverse side of the membrane. Three common types are:

- 1) **Absolute transducers** where the diaphragm pressure is measured relative to a vacuum. **Total pressure is measured and therefore it is necessary to separately monitor atmospheric pressure to allow compensation of the recorded values.**
- 2) **Sealed gauge transducers** where the diaphragm pressure is measured relative to a fixed pressure (usually atmospheric when the instrument was constructed). Depending on the accuracy required it may or may not be necessary to make atmospheric compensation. These transducers are **temperature sensitive** and are therefore best suited to applications such as water pressure monitoring within standpipe piezometers where temperature fluctuations are small.
- 3) **Vented gauge transducers** where the membrane is vented to the atmosphere requiring no atmospheric compensation. For field use extreme care must be taken to prevent moisture or humidity entering the transducer via the vent tube. Moisture can be removed from the air by passing the vent tube through a sealed container of silicon gel. The silica gel should be regularly replaced to maintain a dry environment within the transducer.

**INSTRUCTION 6.4:**

**To calculate tensiometer and piezometer readings using a calibrated transducer.**

**8.10** When a transducer is used with a piezometer or tensiometer installation it is necessary to have the following information before calculation of actual tip pressures is possible.

**8.11** For a tensiometer installation using an **absolute transducer**:

- XDR = output of transducer (mV)
- ATM = output of the atmospheric transducer (mV)
- XDRC = output of transducer at time of calibration (mV)
- ATMC = output of atmospheric transducer at time of calibration (mV)
- XDR gain = gain of the transducer (mH<sub>2</sub>O/mV)
- ATM gain = gain of the atmospheric transducer (mH<sub>2</sub>O/mV)
- TL = vertical difference in height between transducer diaphragm and ceramic tip centre (m)

Given this information the tensiometer tip pressure is given by:

$$\text{Tip pressure (mH}_2\text{O)} = \text{TL} + (\text{XDR} - \text{XDRC}) \times \text{XDR gain} - (\text{ATM} - \text{ATMC}) \times \text{ATM gain}$$

**8.12** For a sealed gauge transducer installed within a piezometer stand-pipe the pressure at the transducer location is given by:

$$\text{Pressure (mH}_2\text{O)} = \text{DL} - (\text{XDR} - \text{XDRC}) \\ \times \text{XDR gain} - (\text{ATM} - \text{ATMC}) \times \text{ATM gain}$$

where:

$$\text{DL} = \text{depth of the transducer from the surface (m)}$$

## INSTRUCTION 6.5

### Selection of data logger with solid state memory design

**8.13** The use of data loggers with a solid state memory is becoming more frequent due to the desirability of such systems. In some systems a typical 100 k byte memory (RAM) can store up to 50,000 readings. In most cases however, the logger is designed to enable data access and processing at set intervals during the monitoring period. In meeting this demand one of three different memory access approaches are frequently used:

- 1) Retrieval of the field logger and down loading of the information in the office or laboratory. For continuous readings it is therefore necessary to have two data loggers.
- 2) The use of a separate interrogator with its own built in memory to down load the data logger in the field and then transfer to the office/laboratory for further down loading using a standard RS 232 link.
- 3) The use of data loggers with removable memories. Spare memory cartridges are required and must be powered up all the time. These systems often need a specialist memory reader for office down loading.

**8.14** The use of an on-site field interrogator allows for immediate data and instrument checking. However it does require field operators and office down loading facilities. A cartridge system has the advantage of transferability in that the data can be easily transported (for example by post) for processing. This is especially useful when the instrumentation is at a remote location.

## INSTRUCTION 6.6:

### Other data logger system considerations, power consumption, reliability and security

**8.15** Many systems are designed to run on an independent power supply. If battery power is used it is essential that a minimum power consumption system is adopted when monitoring for long periods. Typically the system should have a 'wake up' sequence so that the sensors are only powered during the monitoring cycle. The frequency of site visits between battery changes and the interval time of reading will be constrained by the instruments power consumption. **Approximate maximum times between battery changes must be calculated before installation.**

**8.16** The operating reliability of solid state electronics is generally very good as long as conditions remain within tolerance levels. Particular problems occur if there is exposure to moisture as a result of the high humidity and condensation experienced in the tropics. To eliminate such problems it is advisable not to expose any electrical components in the field and ensure that adequate casings are used. It is recommended that silicon gel bags are included within the instrument casings to remove moisture vapour. Problems may also result from exposure to extreme temperatures. This is especially likely when above ground transducers are used. It is important that for such systems instruments are properly insulated.

**8.17** With the use of expensive electrical data logger systems there should be considerable concern about security. The equipment is best located out of general sight and preferably within lockable steel cabinets that are concreted into the ground. Cables between instruments and data loggers should be concealed by burial.

## SUMMARY DECISION STRUCTURE FOR INSTRUCTION 6

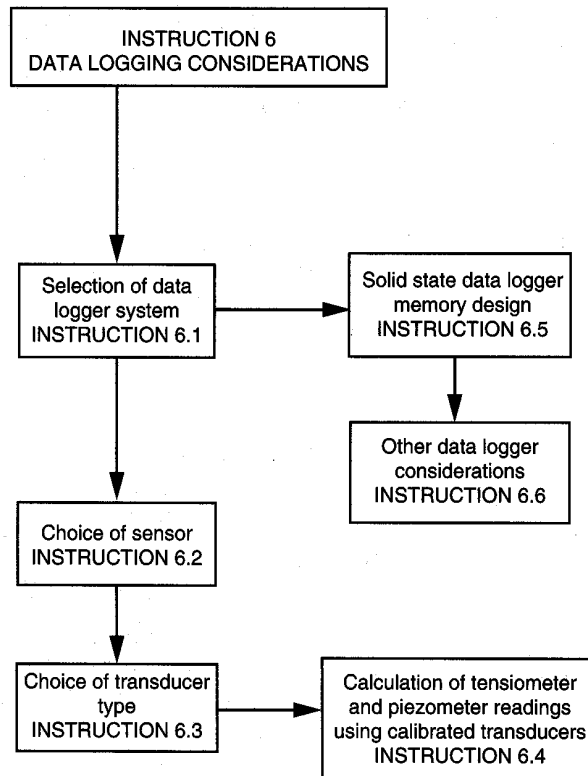

# APPENDIX A: DESIGN CHART

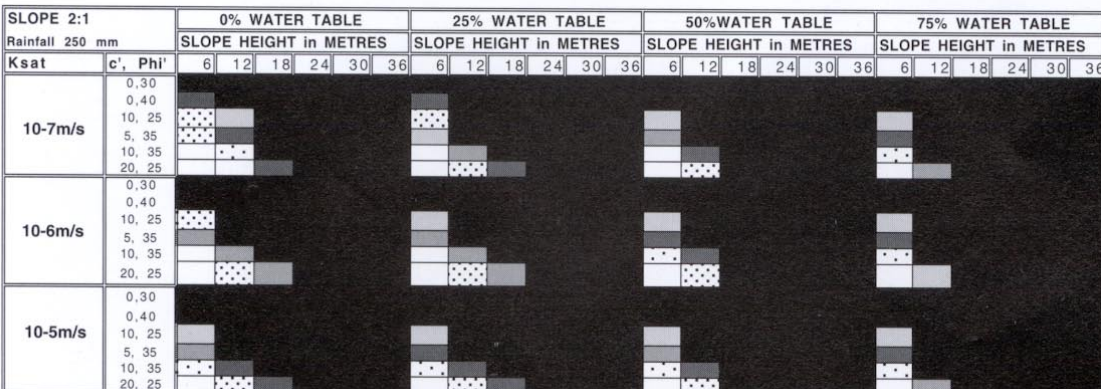
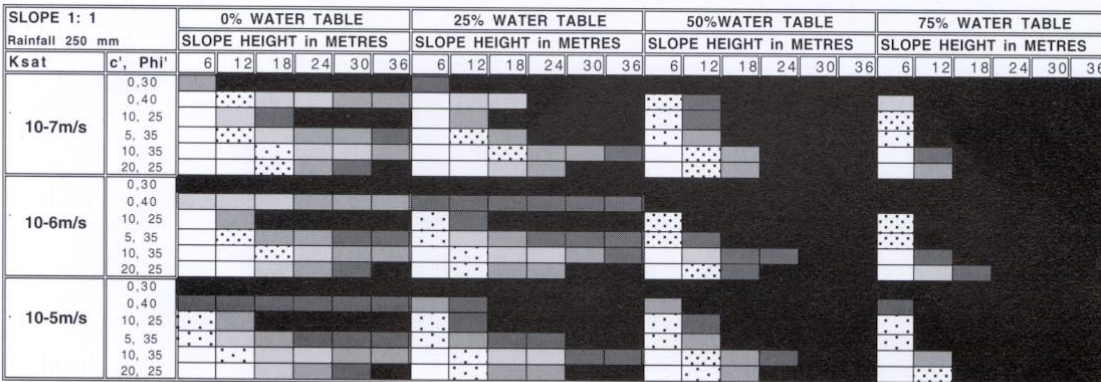
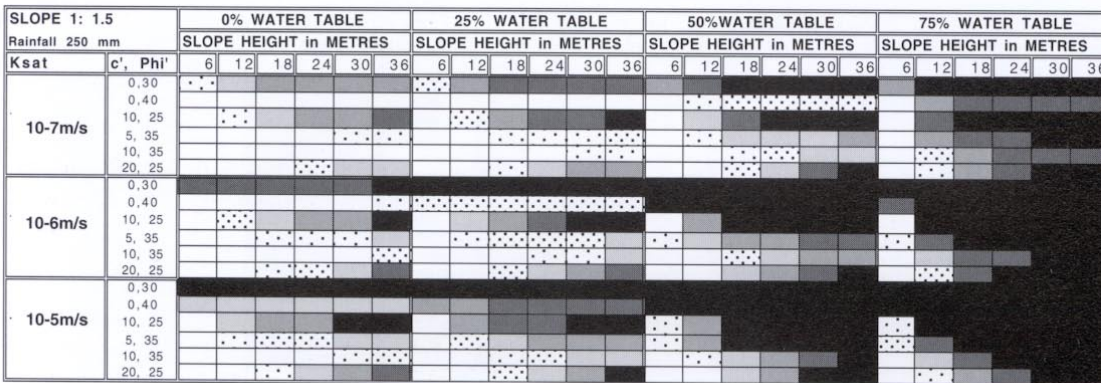
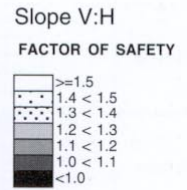
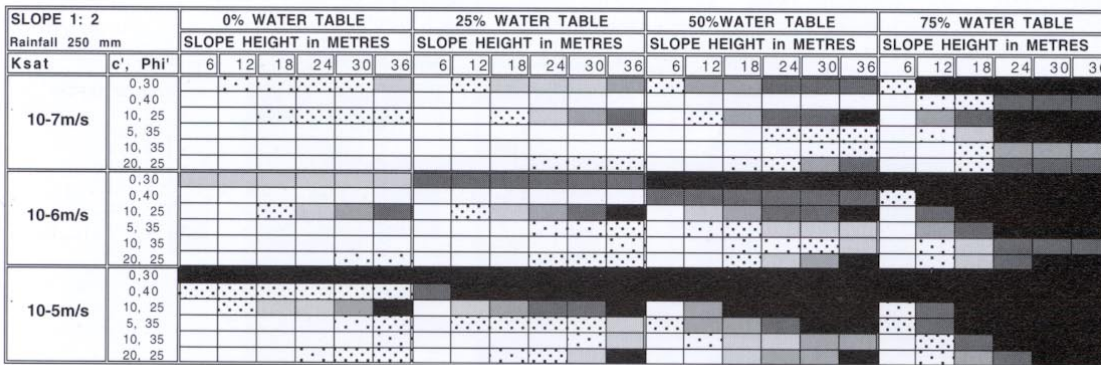

Variation of factor of safety for a 250mm 24 hour rainfall event

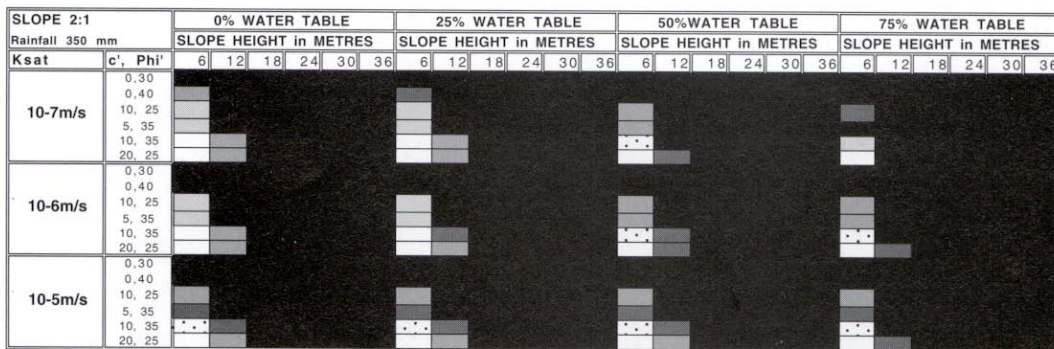
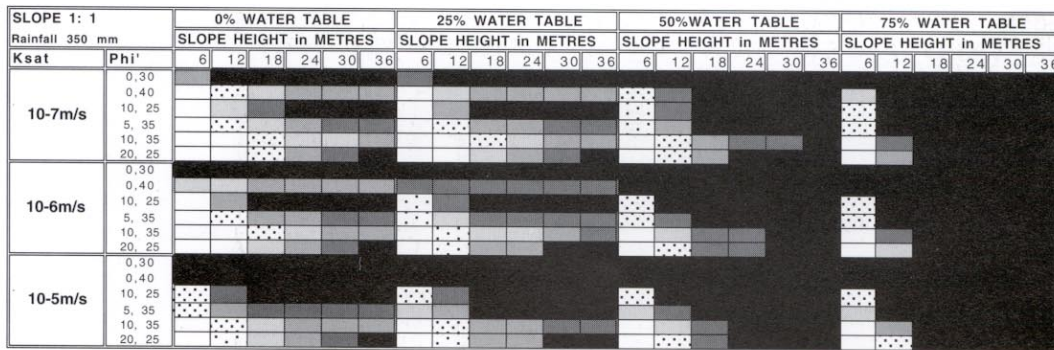
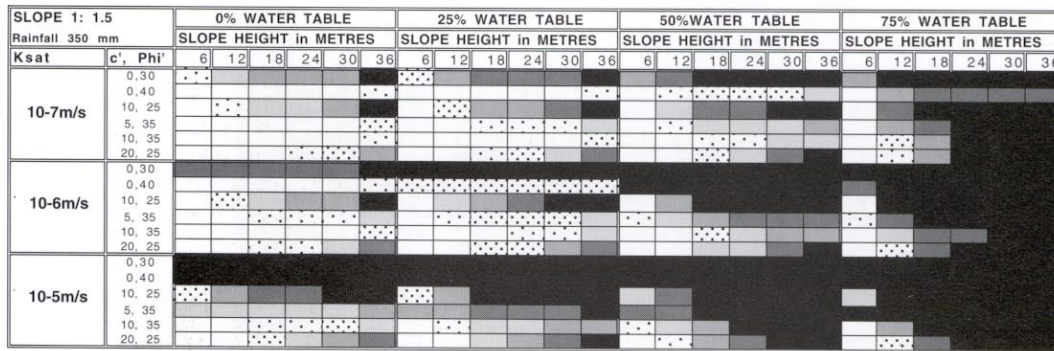
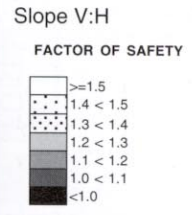
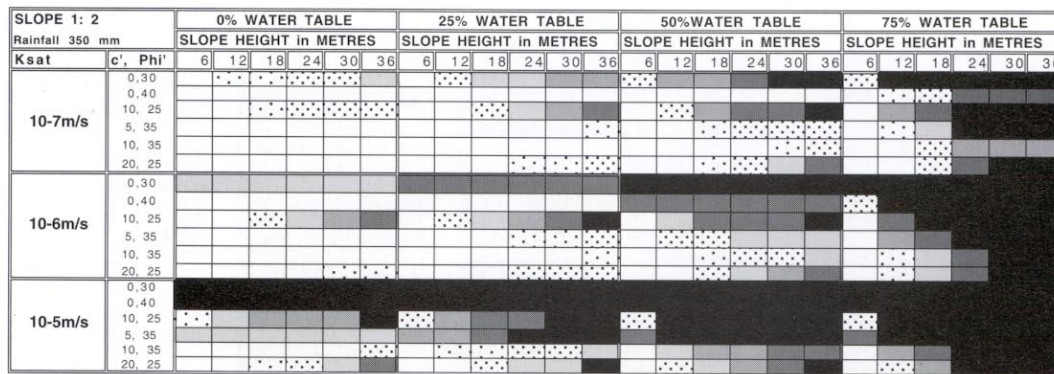

Variation of factor of safety for a 350mm 24 hour rainfall event

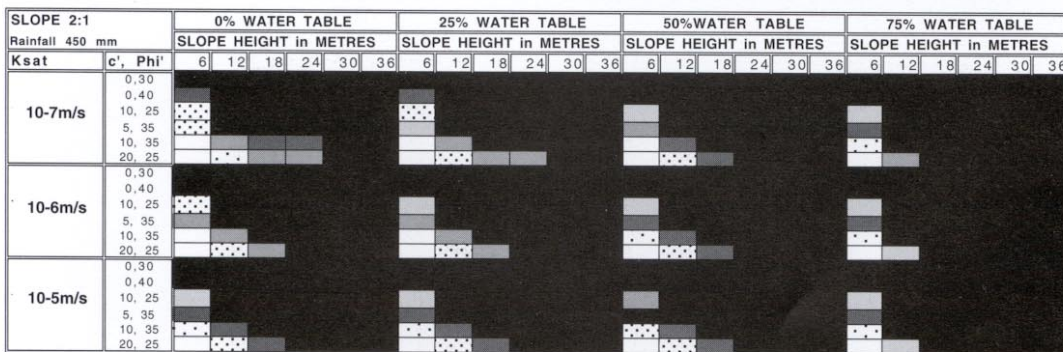
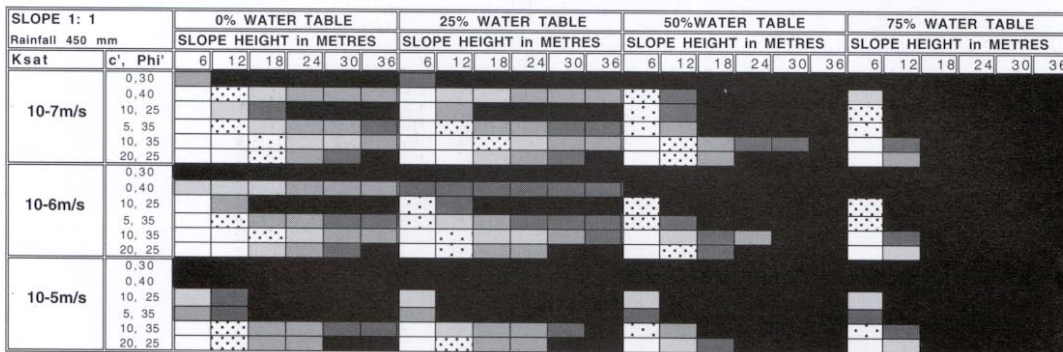
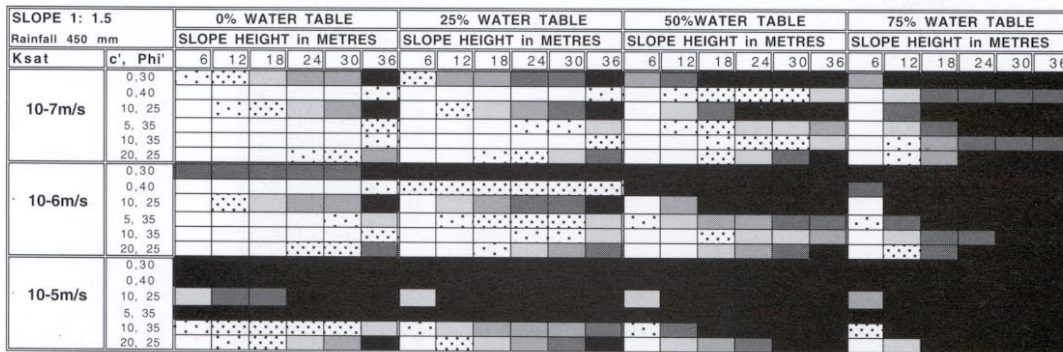
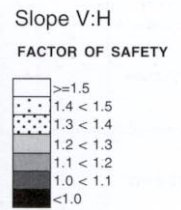
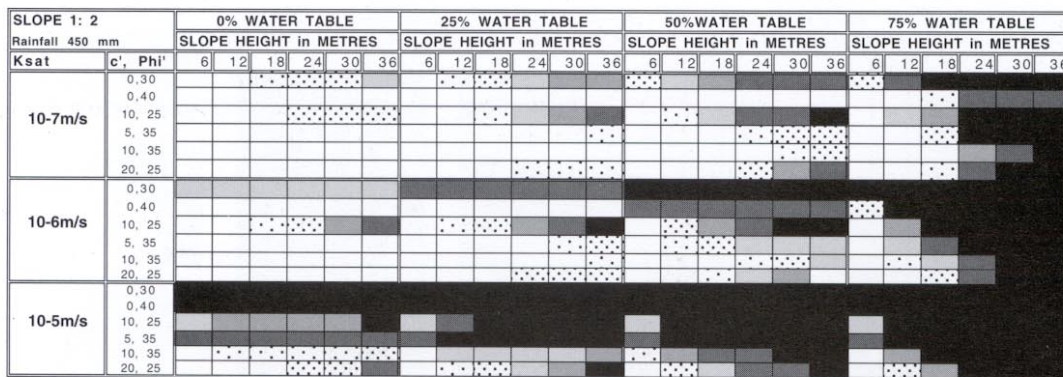

Variation of factor of safety for a 450mm 24 hour rainfall event

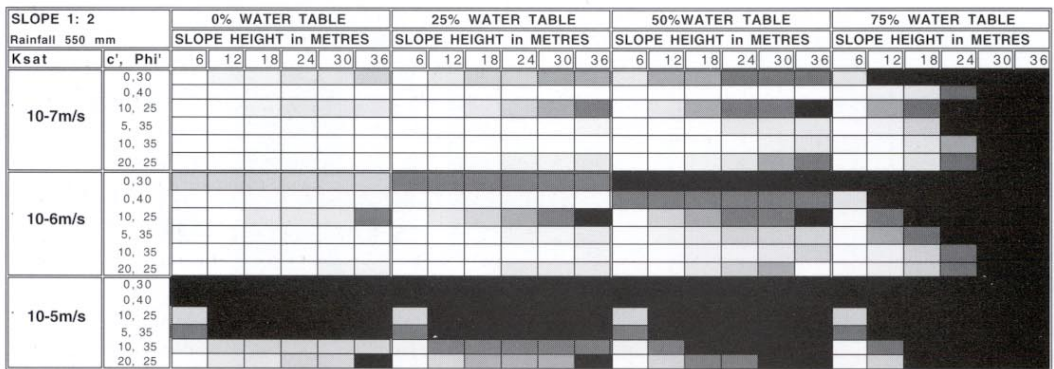

Slope V:H

FACTOR OF SAFETY

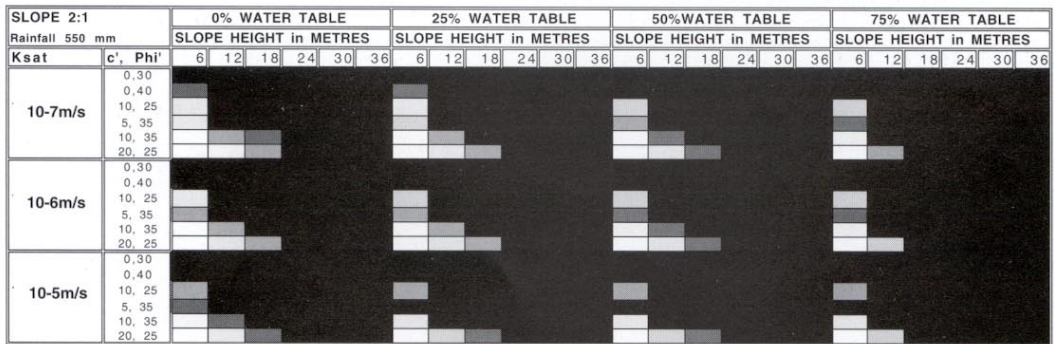
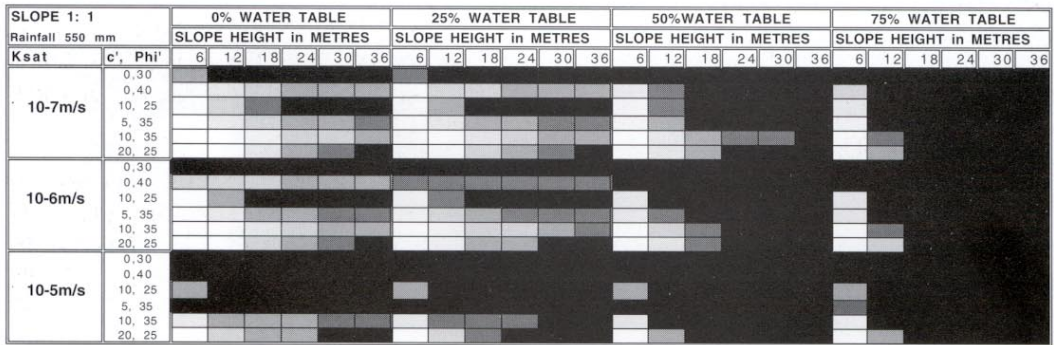
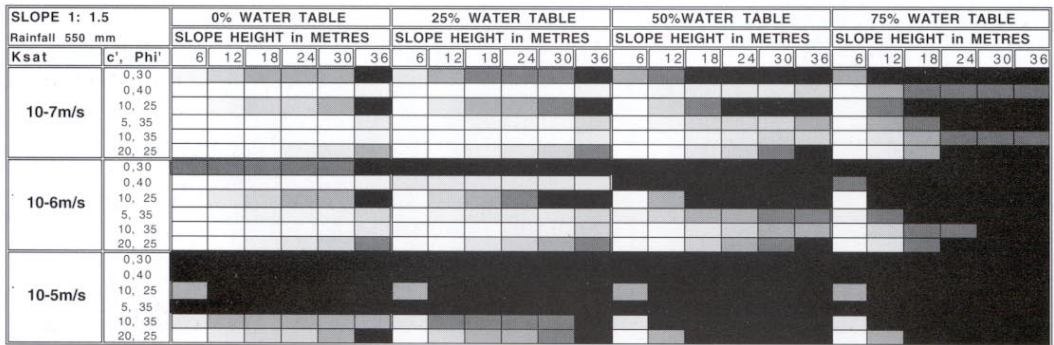
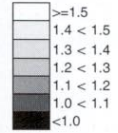

Variation of factor of safety for a 550mm 24 hour rainfall event

## LIST OF REFERENCES

- ANDERSON, M G and P E KNEALE, 1980. Pore water changes in a road embankment. *Highway Engineer*, 25, 93-5.
- ANDERSON, M G and D P McNICHOLL, 1983. On the effect of topography in controlling soil water conditions, with specific regard to cut slope piezometric levels. *Hong Kong Engineer*, 11, 35-4t.
- ANDERSON, M G and P E KNEALE, 1987. Instrumentation of pore pressure and soil water suction. In: ANDERSON, M G and K S RICHARDS (Eds). *Slope Stability: Geotechnical Engineering and Geomorphology*. Chichester: John Wiley and Sons.
- ANDERSON, M G and M J KEMP, 1987. Suction controlled triaxial testing: laboratory procedures in relation to resistance envelope methods. *Earth Surface Processes and Landforms*, 12, 649-654.
- ANDERSON, M G, M J KEMP, D M LLOYD and A OTHMAN, 1990. A combined automatic tensiometer piezometer system. *Earth Surface Processes and Landforms*, 15, 63-71.
- BOSWORTH, D, 1985. An investigation into the controls of overland flow generation. *Ph.D Thesis*, University of Bristol (unpublished).
- BRAND, E W and J PREMCHITT, 1980. Shape factors of cylindrical piezometers. *Geotechnique*, 30, 369-384.
- BRAND, E W, 1982. Analysis and design in residual soils. *Proceedings Conference Engineering Construction in Tropical Residual Soils*, Hawaii American Society, Civil Engineers, 89-143.
- BRAND, E W, G W BORRIE, and J M SHEN, 1983. Field measurements in Hong Kong residual soils. *Proceedings International Symposium Field Measurements in Geotechnical Engineering*, Zurich.
- BRAND, E W, J PREMCHITT and H B PHILLIPSON, 1984. Relationship between rainfall and landslides in Hong Kong. *4th International Symposium Landslides*, Toronto, 1, 377-84.
- BRAND, E W, M J DALE AND J M NASH, 1986. Soil pipes and slope stability in Hong Kong. *Quarterly Journal of Engineering Geology*, 19 (3) 301-303.
- BSI, 1981. Code of practise for site investigations. *BS 5930: 1981*. London: British Standards Institution.
- BSI, 1990. Methods of test for soils for civil engineering purposes. *BS 1377: 1990*. London: British Standards Institution.
- BURT, T P, 1978. An automatic fluid scanning switch tensiometer system. *British Geomorphological Research Group*, Technical Bulletin 21.
- CRABB, G I and J H ATKINSON, 1991. Determination of soil strength parameters for the analysis of highway slope failures. In: CHANDLER, R J (Ed). *Slope Stability Engineering, Developments and Applications*. London: Thomas Telford, 13-18.
- DURHAM, I M, E M O'LOUGHLIN and I D MOORE, 1986. Electronic acquisition of hydrological data from an intensively instrumented hillslope. *Hydrological Processes*, 1, 78-87.
- ENDICOTT, L J, 1982. Analysis of piezometric data and rainfall records to determine groundwater conditions. *Hong Kong Engineer*, 10, 53-56.
- FREDLUND, D G, N R MORGENSTERN and R A WIDGER, 1978. The shear strength of unsaturated soils. *Canadian Geotechnical Journal*, 15, 313-321.
- GEOTECHNICAL CONTROL OFFICE 1984. *Geotechnical Manual for Slopes (2nd edition)*, GCO, Hong Kong.
- HENCHER, S R and R P MARTIN, 1982. The description and classification of weathered rocks in Hong Kong for engineering purposes. *Proceedings 7th South East Asian Geotechnical Conference*, Hong Kong, 1, 125-142.
- HENCHER, S R, J B MASSEY and E W BRAND, 1984. Application of back analysis to Hong Kong. *Proceedings 8th South East Asian Geotechnical Conference*, Bangkok, 631-638.
- HO, D Y F and D G FREDLUND, 1982. Increase in strength due to suction for two Hong Kong soils. *Proceedings Conference Engineering Construction Tropical Residual Soils*, American Society of Civil Engineers, Hono-lulu, Hawaii, 263-295.
- HUDSON, R R and S R HENCHER, 1984. The delayed failure of a large cut slope in Hong Kong. *Proceedings International Conference Case Histories in Engineering*, St Louis, Missouri.
- HVORSLEV, M J, 1951. Time Lag and soil permeability in groundwater observations. *US Army Corps of Engineers, Waterways Experiment Station*, Bulletin 38.
- JANBU, N, 1954. Application of composite slope surfaces for stability analysis. *European Conference Stability Earth Slopes*, Stockholm, 3, 43-49.
- JANBU, N, 1973. Slope stability calculations. In: *Embankment Dam Engineering, Casagrande Volume*, John Wiley and Sons, Chichester, 47-86.

JONES, J A A, M LAWTON, W F WAREING and F G CRANE, 1984. An economical data logging system for field experiments. *British Geomorphological Research Group, Technical Bulletin*, 31.

KEMP, M J, D F NASH, and M G ANDERSON, 1989. Filter design for a Casagrande type piezometer system. *Earth Surface Processes and Landforms*, 14, 375-382.

KOO, Y C, 1982. The mass strength of jointed residual soils. *Canadian Geotechnical Journal*, 19. 225-231.

LEE, R K C, 1983. Measurement of soil suction using MCS600 sensor. *MSc Thesis*, University of Saskatchewan (unpublished).

LEACH, B and R HERBERT, 1982. The genesis of a numerical model for the study of the hydrology of a steep hillslope in Hong Kong. *Quarterly Journal of Engineering Geology*, 15, 243-259.

LUMB, P, 1975. Slope failures in Hong Kong. *Quarterly Journal of Engineering Geology*, 8, 31-65.

LUMSDAINE. R W and K Y TANG, 1982. A comparison of slope stability calculations. *Proceedings 7th South East Asian Geotechnical Conference*, Hong Kong, 1, 31-38.

McFARLANE, 1981. Suction - moisture relationships in residual and remoulded Hong Kong soils. *Public Works Department, Materials Division*, Hong Kong, Report 24.

MILLINGTON, R J and J P QUIRK, 1959. Permeability of porous media. *Nature*, 183, 387-388.

NASH, J M and M J DALE, 1983. Geology and hydrology of natural tunnel erosion in superficial deposits in Hong Kong. *Proceedings Conference Geology of Superficial Deposits*, Hong Kong.

PERRY, J, 1994. A method for defining non-linear shear strength envelopes, and their incorporation in a slope stability method of analysis. *Quarterly Journal of Engineering Geology*, 27 (3).

POPE, R G, R C WEEKS and P N CHIPP, 1982. Automatic recording of standpipe piezometers. *Proceedings of the 7th South East Asian Geotechnical Conference*, Hong Kong, 77-89.

SWEENEY, D J, 1982. Some in situ soil suction measurements in Hong Kong's residual soil. In: McFEAT-SMITH, I and P LUMB (Eds). *Proceedings South East Asian Geotechnical Conference*. Hong Kong: Institute of Engineers, 91-105.

ISSN 0951 - 8797

OS-E

**Hydrological design manual for slope  
stability in the tropics**

**ORN 14**