

# **OVERSEAS ROAD NOTE 13**

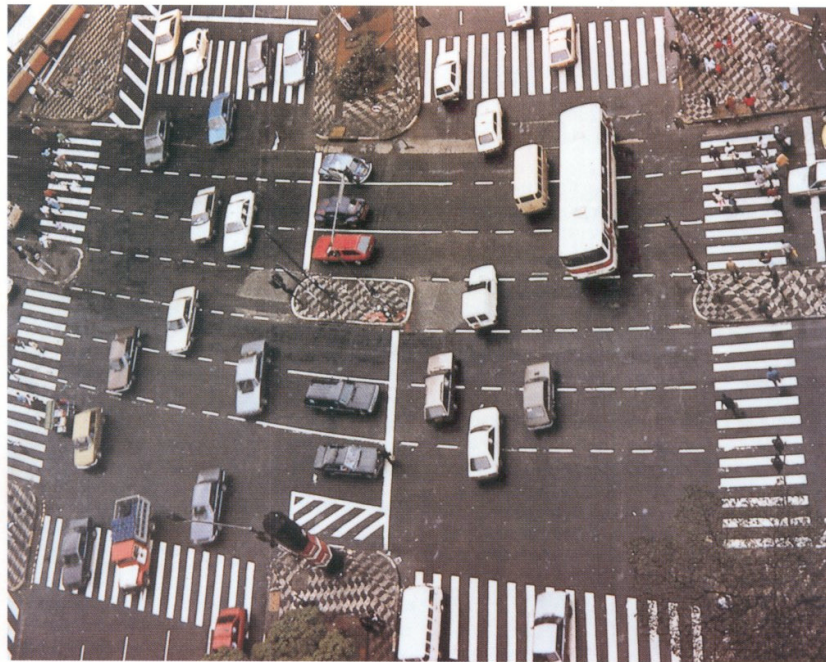

## ***The Use of Traffic Signals in Developing Cities***



Overseas Centre  
Transport Research Laboratory, Crowthorne, Berkshire, United Kingdom



Transport Research Laboratory  
Old Wokingham Road  
Crowthorne, Berkshire, RG45 6AU

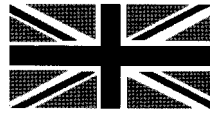

Overseas Development Administration  
94 Victoria Street  
London, SW1E 5JL

## OVERSEAS ROAD NOTE 13

# THE USE OF TRAFFIC SIGNALS IN DEVELOPING CITIES

Main Subject area:	Urbanisation/Transport, energy efficiency
Theme:	Urban Transport
Project title:	The Use of Traffic Signals In Developing Cities
Project reference:	ODA R6016

Copyright Transport Research Laboratory 1996. All rights reserved.

This document is an output from a project funded by the UK Overseas Development Administration (ODA) for the benefit of developing countries. The views expressed are not necessarily those of the ODA.

### Transport Research Foundation Group of Companies

Transport Research Foundation (a company limited by guarantee) trading as Transport Research Laboratory. Registered to England, Number 3011746. TRL Limited Registered in England, Number 31.12272 Registered Offices Old Wokingham Road, Crowthorne, Berkshire, RG45 6AU.

## ACKNOWLEDGEMENTS

This Note was prepared by A. Cannell of Transcraft Consultants, Curitiba, Brazil and G Gardner of the Overseas Centre, Transport Research Laboratory (TRL). Useful advice and assistance was given by D. Singh and J. Cracknell.

First Published 1996  
ISSN 0951-8987

## OVERSEAS ROAD NOTES

Overseas Road Notes are prepared principally for road and transport authorities in countries receiving technical assistance from the British Government. A limited number of copies is available to other organisations and to individuals with an interest in roads overseas, and may be obtained from:

Transport Research Laboratory  
Crowthorne, Berkshire, RG45 6AU  
United Kingdom

Limited extracts from the text may be reproduced provided the source is acknowledged. For more extensive reproduction, please write to:

Programme Director, Overseas  
Centre, Transport Research  
Laboratory.

# CONTENTS

	Page		Page
		Time Settings	18
1. INTRODUCTION	1	Total Lost Time per Cycle (L)	18
2. CRITERIA AND WARRANTS		Flow Factors	18
FOR SIGNAL INSTALLATION	2	Cycle Times	19
3. BASIC TRAFFIC COUNT SURVEYS	4	Green Times	19
4. JUNCTION DESIGN AND LAYOUT	6	Degree of Saturation	20
Typical Layouts	6	Junction Capacity Analysis	20
Siting of Signal Equipments	6	Traffic Signal Calculation Sheet	20
Approaches and Lanes	6	Stage/Phase Sequence Diagram	20
Signal Sequences	7	Check List for Signal Design	20
Signal Design Techniques	9	6. COORDINATION AND LINKING	
Right Turning Vehicles	10	OF TRAFFIC SIGNALS	23
Early Cut Off	10	Simple Progressive System	
Late Start	10	(Green Wave)	23
Pedestrian Facilities	10	Mechanisms for Linking Signals	25
No Pedestrian Signal	11	Cable-Linking	25
Full Pedestrian Stage	11	Cable-less Linking	25
Parallel Pedestrians	11	Fixed Time Coordinated Signals	25
Staggered Pedestrian Facility	11	Area Traffic Control (ATC)	25
Pedestrian Signal Displays	11	Fixed Time ATC Systems	26
Pedestrian Push Buttons.	12	Semi-Responsive Systems	26
Audible Warnings	12	Fully Responsive Control	26
Guard Rails	12	Equipment Testing	2
Pedestrian Signal Sequences and		7. THE TRANSYT PROGRAM	7
Timings	12	8. SYSTEM AND ECONOMIC ANALYSIS	
Vehicle-actuated (V.A.) Traffic Signals	12	OF TRAFFIC CONTROL	30
Stage demands	13	9. SPECIFICATIONS	32
Stage extension	13	Traffic Signal Controllers	32
Semi-vehicle-actuated signals	13	General Road Traffic Signals	32
Traffic Signals on High Speed Roads	13	Inductive Loop Detectors	32
Speed-related Green Extensions	13	Associated Electrical Works	33
Visibility Requirements	13	Traffic Signal Controller Civil Works	33
Bus Priority	13	10. GLOSSARY	34
5. CALCULATION OF TRAFFIC SIGNAL		11. REFERENCES	36
TIMINGS - WEBSTER'S METHOD	16		
Cycle	16		
Intergreen Period	16		
Minimum Green Period	16		
Estimation of Saturation Flow	16		
Width of Approach	16		
Gradients	17		
Traffic Composition	17		
Turning Traffic	17		
Parking, Waiting and Bus Stops	18		

# THE USE OF TRAFFIC SIGNALS IN DEVELOPING CITIES

## 1. INTRODUCTION

**1.1** A traffic signal installation is a power-operated device which informs motorists or pedestrians when they have the right of way at a particular intersection.

**1.2** The first traffic signal was installed in London in 1868 and used semaphore 'arms' together with red and green gas lamps. Unfortunately, it exploded, putting an end to this sort of control for 50 years.

**1.3** However, in 1918 the first three coloured light signals were installed in New York and in 1925 they started to be used in Great Britain.

**1.4** At the beginning of the 1930's an attempt at making the signals more 'intelligent', or vehicle responsive, was tried in America, using microphones at the side of the road, requiring drivers to sound their horns. This was obviously not too popular and the first traffic detectors - electrical and pneumatic - were invented.

**1.5** Traffic signals are now used throughout the world, using the three light signals of Green, red and amber. Also, by convention, these are normally arranged vertically with the red signal at the top and the green light at the bottom. This also helps people who are colour blind - both drivers and pedestrians - to identify the differences between the lights.

**1.6** Traffic signals are used at intersections to reduce conflicts to a minimum by time sharing of right of way. This actually reduces the capacity of the intersection, but greatly enhances safety.

**1.7** Conflicts at intersections are illustrated in Figure 1 which shows the potential conflict points at the junction of two roads, both with two way traffic flows, at which all crossing and merging movements are permitted.

**1.8** With the provision of traffic signal control the number of potential conflicts can be reduced from 64 to zero.

**1.9** The object of this report is to give traffic engineers or technicians in the cities of the emerging world a brief introduction to traffic signals, together with some practical guidelines on how to use them to obtain good and safe results.

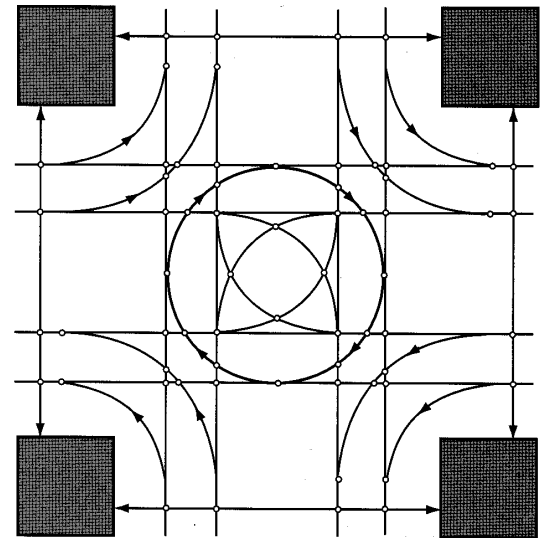

**Figure 1 Conflict points at an intersection**

**1.10** There is no doubt that signals are one of the most powerful tools for urban traffic control available to city authorities and their correct installation can improve both traffic flow and the safety of all road users. In comparison to other traffic improvements, signals are also relatively low capital intensive and in recent years the advancement in informatics and telecommunications has led to a new generation of low cost controllers and systems that have made modern signalling an even more attractive and powerful tool.

**1.11** Essentially, traffic signals form part of the "software" of a city as opposed to the roads and bridges that are part of it's "hardware". As such they have the advantage of being cheap and often the disadvantage of being so cheap that no local lobby is interested in them, especially when city mayors fail to see the political advantages in changing an old signal for a new one.

**1.12** It is thus part of the traffic engineer's task to prove to city authorities that a modern and well designed traffic signal system will bring real and visible benefits to the city.

## 2. CRITERIA AND WARRANTS FOR SIGNAL INSTALLATION

2.1 When two or more traffic flows are competing for the same road space at a junction, some form of control - or set of rules - is needed to minimize delays and the risk of serious accidents. In some countries, a simple rule of preference states that the traffic coming from the left (or right where there is right-hand drive) has priority to enter the junction. As few people tend to know - or obey - this rule, unsignalled junctions can come under "popular control" and users have to consider that the larger vehicle, or the one that sounded the horn first, or a public transport bus, etc., may have priority.

2.2 This is obviously inefficient and dangerous, so with higher flows some form of **stop or priority** sign is used to inform to the user on one or more approaches that the other road has right of way. At even higher flows this form of control breaks down when the delay on the minor road becomes too high, forming queues and forcing drivers to run the risk of accepting gaps in the major road traffic that are too small for a safe crossing. At this point, time must be allocated for the right-of-way to traffic on the various approaches.

2.3 However, the introduction of traffic signals (or lights) into a city often runs the risk of these equipments being considered a panacea for all traffic problems. The engineer or technician in charge of the traffic comes under political and popular pressure to install too many signals, thus leading to the even greater risks of red-running - as the users 'learn' to disrespect the red lights that they consider to be unnecessary.

2.4 To avoid this problem it is essential that the engineer or traffic department has a clear set of **warrants** to justify the use of signals.

2.5 If possible, these warrants should be approved by the local government bodies (elected and executive) so that requests for signals on sites that do not need them can be refused according to pre-discussed rules - and not just on the personalized decision of the head of the traffic department.

2.6 Traffic signals may be justified if, usually two, of the following criteria are present:

- where there is a minimum major-street/minor-street conflicting vehicle volume;
- where there may be need to interrupt continuous flow on the major road to allow traffic to exit from the minor road without excessive delay;
- where a minimum pedestrian volume conflicts with a minimum vehicle volume;

- where a schoolchildren crossing is present;
- where there is a need to maintain progressive movement of vehicles along an otherwise signalled route; and
- where there is a record of accidents of the type which could be reduced by the use of traffic signals.

2.7 A rough and ready set of warrants might be:

**traffic flows** - when there is a minimum of 1000 pcu's per hour entering the junction during the peak hours.

**visibility** - when drivers on the minor road have poor visibility for judging gaps.

**accidents** - when three or more accidents (collisions or pedestrians) are registered per year.

2.8 Figure 2, for example, shows the relationship between major-road/minor-road flows and the type of control recommended at a junction in the UK. For a major road flow of 20,000 pcu's per day and a minor road flow of 6,000, a roundabout would be a good solution for eliminating the conflicting traffic movements - if space were available. If, however, the junction is in a built-up area, then traffic signals probably represent the best solution.

2.9 It should be stressed, however, that traffic signals if located or timed wrongly can INCREASE delays and accidents and their maintenance and electrical supply represents an ongoing cost of around US\$1000 to 2000 per year.

2.10 To minimize the need for signals, the road hierarchy should try to conform to the network shown in figure 3, which offers the most efficient and safe layout.

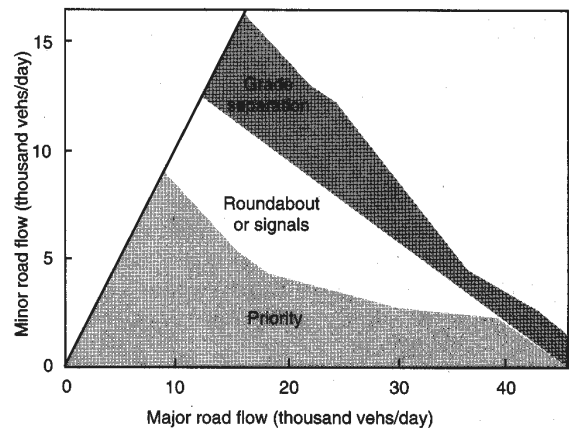

Figure 2 UK practice for intersection control selection based on combinations of traffic flow

2.11 A method of reducing conflicts on local distributors and access roads is to physically separate traffic flows, allowing access but avoiding the pressure to install new lights.

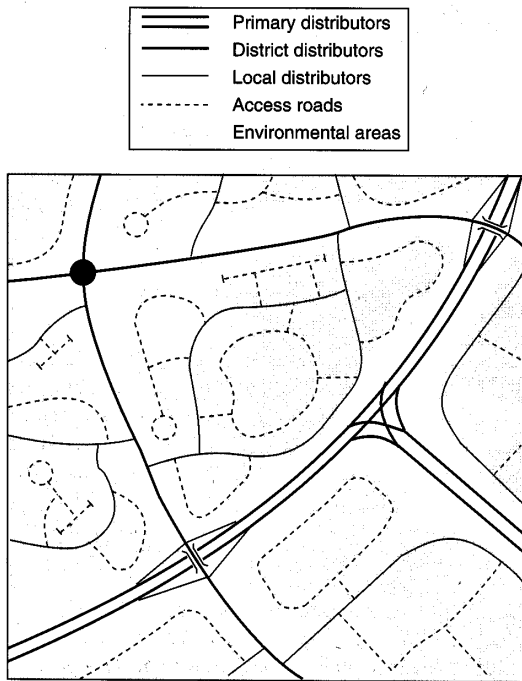

Figure 3 Ideal urban road network

2.12 Figures 4 and 5 show how, in some cases, conflicting flows may be avoided - provided that no economical or environmental restrictions exist.

2.13 If, however, traffic lights are to be installed, the engineer and police forces should be in agreement on how the flows are controlled. In many developing cities, the police will often take manual control, assuming that they can reduce traffic queue lengths. Research has shown that this is not true (Walker et al, 1988). Police are reluctant to stop a traffic stream even when it is no longer saturated, as shown in figure 6. It is preferable to allocate police to control illegal parking, removal of breakdowns and enforce driver behaviour.

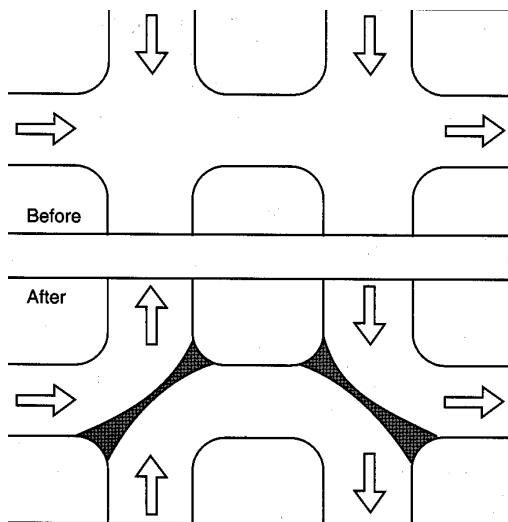

Figure 4 Elimination of conflicts at a junction pair

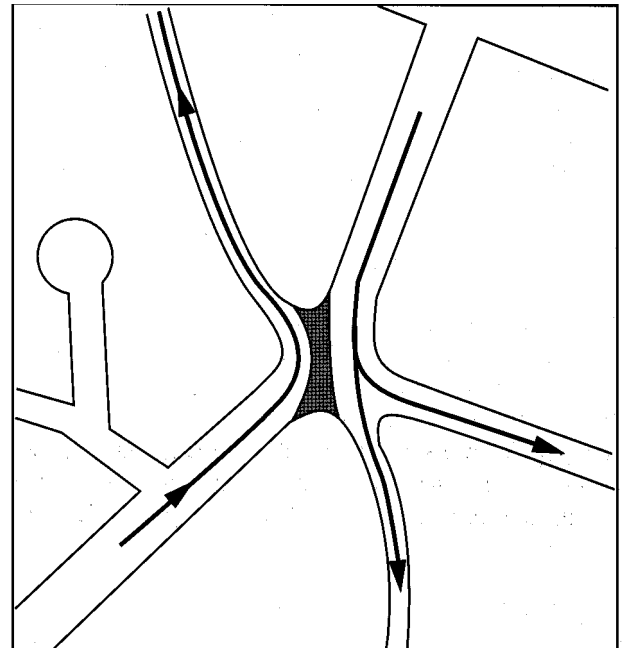

Figure 5 Eliminating the need for traffic signals - "7 esquinas", Arequipa, Peru

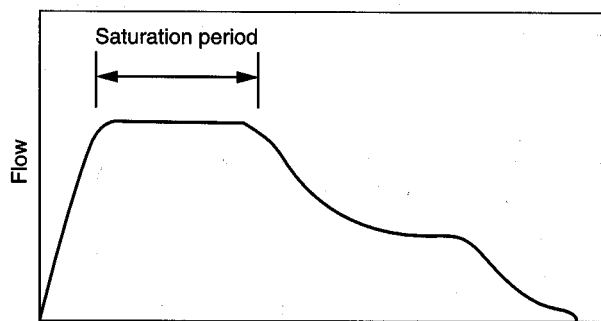

Figure 6 Typical flow/saturation relationship for police control - inefficient use of the end of the green period

### 3. BASIC TRAFFIC COUNT SURVEYS

3.1 For each site where traffic signals are being contemplated it is fundamental to obtain adequate data on the traffic flows at the junction. Normally, surveys would be carried out during the peak hour periods. However, it may be important to have a broad view of the flows in the city throughout a normal working day, especially when Area Traffic Control or linked signalling are being considered.

3.2 Traffic counts are likely to be divided into two types:

- all day counts (normally during 16 hours of a work day) usually mid block on key roads, with the objective of defining the duration of the peak periods and general vehicle composition; and,
- specific junction counts carried out with the objective of providing the data for evaluation and design of the junctions.

3.3 The classification of vehicles might be cars, taxis, light vans, trucks (heavy and medium) and public service vehicles. In some cities it will be necessary to include motorcycles, cycles or other common vehicle types. The counts should be made in periods of about 15 minutes, during at least two working days. If the counts are not similar (as demonstrated in figure 8), then the counts should be repeated on another working day.

A simple 16 hour survey form could look like figure 7.

3.4 Specific junction counts are aimed at providing the data for detailed evaluation and design. The peak periods can be identified from the all day (16h) counts and the junction counts should be undertaken in the peaks - including the "shoulders" just before and after the peaks. Unless a city is subject to excessive congestion, this usually means a count period of about two hours for each peak. If an ATC scheme is under consideration, counts should also be carried out at weekends.

3.5 Each surveyor can usually manage to count two independent flows. For a simple junction involving two one-way streets, two surveyors (normally temporary staff) will be needed, as shown in figure 9.

3.6 Each site should also be carefully checked to make sure that pedestrian volumes during the peak hours that might require special phases are also considered.

3.7 Counts in congested areas often suffer from the spillback of upstream queues which means that surveyors will not count the real demand of the traffic that wants to go through the junction, but only the traffic that actually manages to pass. This can lead to the classic case, in which

Department/Project Title				Name of Surveyor		Ref.	
Sketch of Site				Date			
				Observations:			
				(Anything that might affect the quality of the information)			
Time	Cars	Buses	Trucks	Time	Cars	Buses	Trucks
0500-0515				0700-0715			
0515-0530				0715-0730			
0530-0545				0730-0745			
0545-0600				0745-0800			
0600-0615				0800-0815			
0615-0630				0815-0830			
0630-0645				0830-0845			
0645-0700				0845-0900			

Figure 7 Simplified traffic survey form

a survey is made during a widespread "gridlock"; reported by the surveyors in terms of near zero flow on all approaches.

3.8 TRL ORN 11, "Traffic Surveys in Developing Cities" should be consulted for further reference.

3.9 **The warrants used and/or approved by the city to justify the installation of signals are likely to include accidents. It must be stressed that an updated accident data base is essential for completing the traffic surveys.**

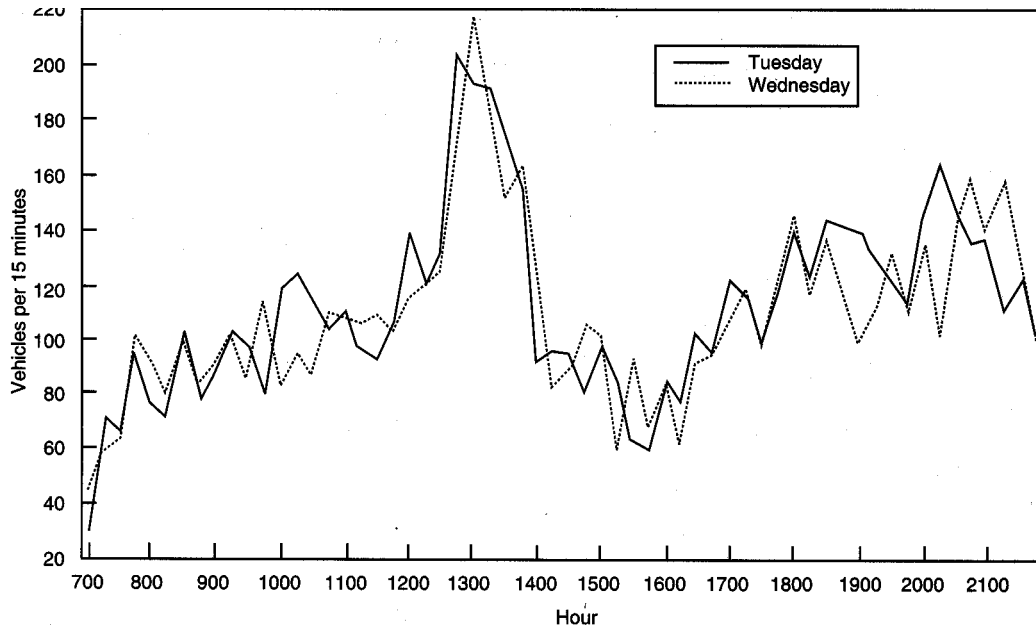

Figure 8 16 hour traffic count on Peru Street, Mendoza, Argentina, During two working days

Department/Project Title				Name of Surveyor				Ref.			
Sketch of Site				Date							
				Observations:							
								(Anything that might affect the quality of the information)			
1				2							
Time	Cars	Buses	Trucks	Time	Cars	Buses	Trucks	Time	Cars	Buses	Trucks
0700-0715				0700-0715							

Department/Project Title				Name of Surveyor				Ref.			
Sketch of Site				Date							
				Observations:							
								(Anything that might affect the quality of the information)			
1				2							
Time	Cars	Buses	Trucks	Time	Cars	Buses	Trucks	Time	Cars	Buses	Trucks
0700-0715				0700-0715							

Figure 9 Survey forms for a simple junction of two one-way streets

## 4. JUNCTION DESIGN AND LAYOUT

4.1 The aim of any junction layout is to provide for the safe movement of traffic, both vehicular and pedestrian, without undue delay or congestion. Various alternative layouts may be considered and the ultimate choice will be governed by such factors as the nature and volume of traffic using the junction, the availability of land and the cost.

4.2 The overall capacity of a road network is limited by the capacity of individual junctions. Failure to provide the correct type of layout at one particular junction may result in accidents, congestion and delay to an extent which may impair the efficiency of the road system over a wide area.

### TYPICAL LAYOUTS

4.3 The following descriptions of junction layout and design procedures are based mainly on UK practice. Other standards are of course possible. For example, in the UK signals are located on the kerb, at the roadside with the "primary" signal close to the stop line. In many countries overhead signals on the "far side" of the junction are the norm. Both methods have their merits, however, a country will generally have its own standards and such standards have to be adopted in designs. The important requirement is that signals should be consistently designed, located and operated throughout the city and clear unambiguous indications given to all road users.

### SITING OF SIGNAL EQUIPMENTS

4.4 The minimum requirement is one traffic signal installed 1 m from the stopline, on the nearside of the carriage-way. If possible a second primary signal should be installed if there is a central island or divider, or more than three approach lanes. Minimum visibility distances from the primary signals are given in Table 1

TABLE 1: VISIBILITY DISTANCES

85 percentile approach speed	visibility distance (m)
50 km/h	70
60 km/h	95
70 km/h	125
85 km/h	165
100 km/h	225

4.5 A secondary signal is normally installed diagonally opposite the first primary signal, as shown in figure 12.

4.6 When the signal method of control contains a special right turn phase, extreme care should be used in the siting of secondary signals for the direction of flow which loses

right of way first. The secondary signal in this case should not be placed beyond the nearside of the junction.

### Approaches and lanes

4.7 It is essential that approaching drivers are made fully aware of the nature of the junction by adequate signing. Carriageway markings and/or channelized islands should be used to guide users on the correct path, and visibility should not be impaired.

4.8 Approaches should be marked out in lanes. Lane widths at signalled junctions should normally be between 3 and 3.6m, although 2.7m is acceptable in some instances where speeds are low and there are few large vehicles (trucks or buses).

4.9 On roads where land is available the saturation flow and capacity of an approach can be increased by widening the road to the vicinity of the junction to provide more ahead lanes. An example of this is shown in figure 10. Another option, where there are large turning movements is to divide the road space available to favour the turning lanes, as shown in figure 11.

4.10 Perhaps the most important factor affecting the capacity of a junction approach is the need to avoid obstruction to traffic flow, either temporary (a taxi or bus stopping for passengers) or permanent (a parked car). Plate 1. clearly shows the problem caused by a (very) long term parked car which has eliminated a lane of traffic. In a situation such as the example in plate 2, even the most sophisticated traffic signals will not improve the traffic flow.



Plate 1. Parked car obstructing the approach - a severe capacity loss

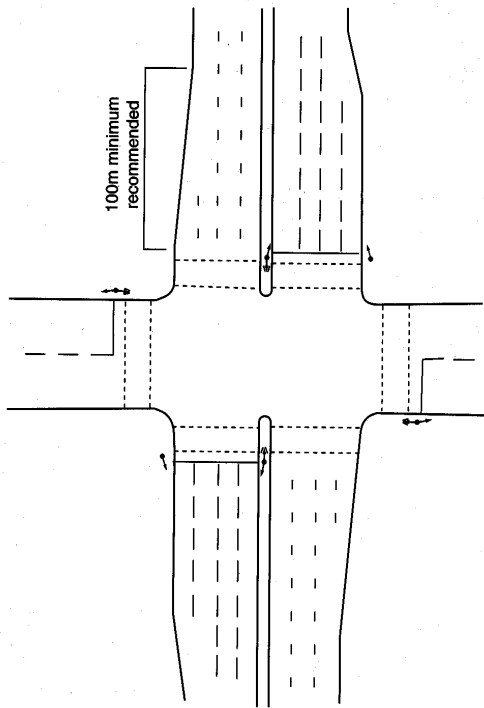

Figure 10 Flared junction approach

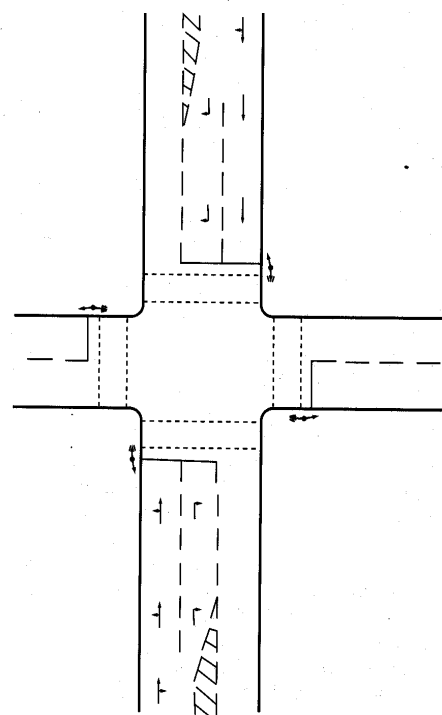

Figure 11 Extra road space given to approaches

TABLE 2: APPROACH LANE WIDTHS

Approach width (m)	Lane width (m)			
	Lane 1	Lane 2	Lane 3	Lane 4
3-5	3.50			
5.50	2.75	2.75		
6.00	3.00	3.00		
8.00	4.00	4.00		
8.50	3.00	2.75	2.75	
10.00	3.40	3.30	3.30	
11.50	3.10	2.80	2.80	2.80

Lane 1 is nearest the kerb

### SIGNAL SEQUENCES

**4.11** Each signal face normally has three vertical lights with a nominal diameter of 200mm. The height of the centre of the green lens from the surface of the carriageway (where light signals are placed at the side of the carriageway) should be not less than 2.1 metres nor more than 3.5 metres. If signals are placed over the carriageway, this distance should not be less than 5.0 metres nor more than 9 metres.

**4.12** Traffic control is by means of red, amber and green signals, supplemented by additional green arrow light signals, tram signals, etc.

**4.13** The signal sequence at junction traffic signals in British practice countries is red, red + amber and green, amber and red. Most Panamerican standard countries, however, use the sequence red, green, amber and red and some countries adopt other variations, eg. flashing green in place of amber.

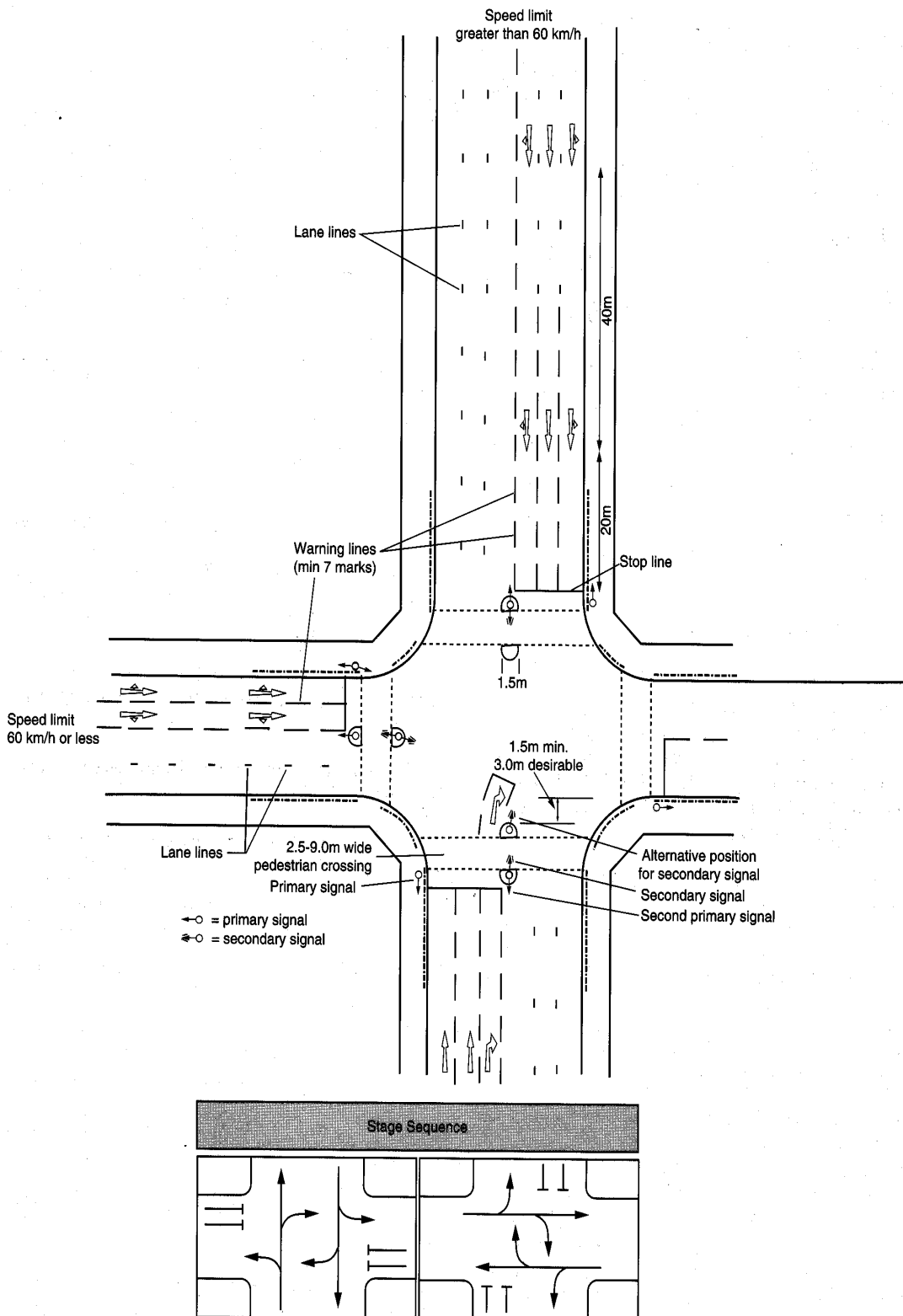

Figure 12 Typical layout of a signalled controlled junction



**Plate 2. Street markets: a safety risk as well as a huge capacity restraint**

**4.14 the red light signal** indicates the prohibition that vehicular traffic shall not proceed beyond the stop line provided in conjunction with the light signals, or if the stop line is not visible (or there is no stop line), beyond the light signals.

**4.15 the amber light signal** when shown alone, indicates the prohibition that vehicular traffic shall not proceed beyond the stop line, or if the stop line is not visible (or there is no stop line), beyond the signals, except in the case of any vehicle which when the light signal first appears is so close to the stop line or light signals that it cannot be safely stopped before passing the stop line or light signals. The time for the amber signal is normally fixed for the city or region at 3 or 4 seconds.

**4.16 the red and amber light signals** together indicate an imminent change from red to green. However the red light still prohibits forward movement.

**4.17 the green light signal** means that traffic may proceed, if safe to do so.

**4.18 the green arrow signal** indicates that traffic may proceed only in the direction indicated by the arrow.

**4.19 a flashing amber signal** in some countries means that drivers must proceed with caution. Normally displayed on all approaches with a frequency of 1 hertz (1 flash per second), this signal is sometimes used from midnight to 4 or 5 o'clock in towns with notorious night time red-running.

**4.20** Pedestrian signals are red and green, either with a green walking man and a red standing man, or with "WALK/ DON'T WALK" signs.

**4.21** There are two alternative concepts used in describing the control of traffic by means of light signals. One, known as stage control, is concerned with the sequential

steps in which the junction control is varied. The other, phase control, refers to the periods of time allocated to each traffic stream.

**4.22** In UK practice a **phase** is used to describe a set of traffic movements which can take place simultaneously or the sequence of signal indications received by such a set of movements. A **stage** is that part of the cycle during which a particular set of phases receives a green indication.

**4.23** In USA based practice, a **phase** is that part of a cycle allocated to any combination of traffic movements receiving the right-of-way simultaneously during one or more intervals. An **interval** is a period of time during which all signal indications remain constant.

**4.24** The **cycle** is the complete series of stages during which all traffic movements are served in turn. The cycle time is the sum of each of the stage times.

## SIGNAL DESIGN TECHNIQUES

**4.25** Conflicts are reduced at signal controlled junctions by holding certain traffic streams stationary while others are allowed to pass. To hold all streams and release each in turn would remove all conflicts but would not be satisfactory since delays to all traffic would be high and effective capacity of the junction would be low.

**4.26** The art of designing an installation is to reduce delay and increase capacity while still maintaining a high degree of safety.

**4.27** Reduction in total delay and improvement in capacity can be achieved by:

- utilizing the lowest practicable number of stages in any signal cycle.
- ensuring that each approach is capable of carrying the maximum predicted traffic flow for that approach.
- ensuring that the time allotted to each stage is appropriate to the actual traffic flow.
- if appropriate, coordinating the control of adjacent junctions to maintain the flow of traffic 'platoons'.
- allowing simultaneous non-hooking right turns.
- separating left turn movements with an exit lane controlled only by a "give-way" priority sign.
- where the degree of conflict is acceptable and movements can be executed safely **with the exercise of due care**, a conflicting move may be accepted (e.g. a right turn on full green).
- restriction of movements, e.g. banned right turns, where conflicting manoeuvres are forbidden.
- separation of traffic streams which conflict, assigning them to different stages.

- considering different stage sequences for different times of the day.
- providing extra lanes for turning traffic or flares on junction approaches.
- combining the green periods for vehicles and pedestrians when this can be done safely.
- providing two separate green periods in a cycle (repeated greens) for important movements.

4.28 As an example of these principles, figure 12. shows a four arm junction with two stages with all movements permitted. This is a very common junction and two stage operation forms the basis of signalling techniques. Traffic on opposite arms flows simultaneously, while traffic on the other two arms is stopped. Each arm may have one or more lanes on approach but the right turning traffic may impede vehicles wishing to proceed over the junction if the road width is restricted. Where there is a relatively minor right turn flow the capacity of the junction is reduced by the road space occupied by such traffic waiting to turn right and by the time which has to be provided to this movement in the cycle. If the right turn manoeuvre is removed then reduced delay and improved capacity can be expected. An alternative route may often be indicated to traffic before the junction is reached. Usually motorists can turn left before the junction, make two right turns to appear at the junction on the left hand arm (known as a 'g' turn). Alternatively motorists can pass through the junction, turn left and make two further left turns to appear at the junction on the left arm (known as a 'q' turn). Such "q" and "g" turns should be carefully evaluated as there will be increased costs to set against savings in junction delay. In the case of "q" turns, the use of the junction twice by former right turn traffic may adversely affect junction capacity and thus delays and operating costs.

### RIGHT TURNING VEHICLES

4.29 The usual practice is for opposing right-turners to turn on the nearside of each other. With this arrangement locking of turning movement cannot occur but driver visibility may be restricted.

4.30 On high speed roads or where right turning movements are heavy (above 300 pcu/s/h), separately signalled and segregated lanes are strongly recommended.

4.31 Another very common situation is the four arm junction with three stages. The types of control are known as either early cut-off or late start.

### EARLY CUT OFF

4.32 To facilitate a heavy right turn movement from one approach, the green time of the opposing approach can be cut off some seconds before the approach with the right turn.

4.33 The approach which is permitted to flow over two stages should have a three light primary signal. The secondary signal, placed beyond the junction, should have four lights, including a right turn arrow of 300mm diameter (in addition to the full green signal) illuminated on the second stage when the opposing traffic has been signalled to stop, as shown in figure 13 and 14.

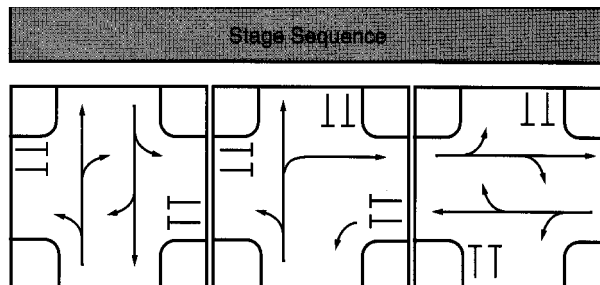

Figure 13 Early cut off stage sequence

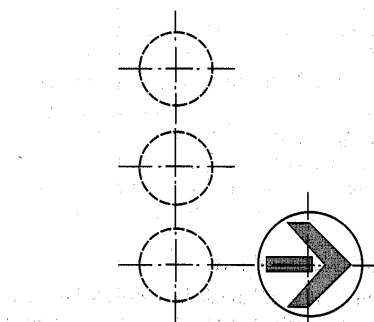

Figure 14 Green filter arrow for right turn LATE START

4.34 An alternative way of dealing with right turning traffic is to delay the start of the opposing traffic by a few seconds. This method causes difficulty at the start of the following stage if the right turn flow is heavy and the opposing traffic cannot establish precedence. For this reason a late start stage is usually not recommended.

4.35 When both right turn movements are heavy, another option available is to hold both right turns with a red signal while the ahead and left turn traffic flows unhindered. All traffic is then stopped before the right turn traffic on both approaches is released together on the same stage. It is usual to separate the right turn traffic onto exclusive lanes with separate signals on each approach. This method should be employed on high speed roads.

### PEDESTRIAN FACILITIES

4.36 When a traffic signal installation is being designed or modified, the nature and extent of pedestrian flow has to

be taken into account as well as that of vehicular traffic. The object of providing pedestrian facilities is to assist pedestrians to cross in safety, with the minimum delay to both pedestrian and vehicular traffic.

**4.37** There are a number of alternative methods of achieving this aim and the engineer has to consider which of these methods can be best applied to individual sites, knowing the pedestrian flow pattern, degree of saturation and site layout.

**4.38** Each junction should be considered on its own merits, taking into account factors such as infirm or handicapped pedestrians, junction capacity and any available accident statistics.

**4.39** If full pedestrian stages are new to the local traffic culture, great care should be taken to introduce them only when accident data and high pedestrian flows justify their need.

### NO PEDESTRIAN SIGNAL

**4.40** The presence of traffic signals at an intersection provides assistance to pedestrians in crossing the arms of a junction, especially where refuges are available, and in many cases no further facility is necessary. An extended all red period between two traffic stages to assist pedestrians is not recommended. This practice leads to increased delays to traffic and to driver disobedience since the extended period will always be present even when there are no pedestrians.

### FULL PEDESTRIAN STAGE

**4.41** With this facility, all traffic is stopped while pedestrian movement is signalled across all arms of the junction. This method will cause delay to traffic. However, the stage can be programmed only to operate during certain hours or by demand from push buttons. Where the crossing is across a dual carriageway, additional push buttons on the central reserve should also be considered.

**4.42** Although pedestrians may be allowed to cross any of the approaches to an intersection there will usually be one approach upon which the pedestrian problem is most acute. The pedestrian stage should immediately follow the end of the vehicle stage on this approach. The signal sequence should be arranged to ensure that on termination of the pedestrian period, the right of way will revert to a nominated stage in the absence of other demands.

This is shown in figure 15.

### PARALLEL PEDESTRIAN STAGES

**4.43** Where it is possible to prohibit permanently some turning movements a combination of pedestrian and vehicle stages can be installed. By virtue of banned turns, pedestrian facilities can be provided across appropriate arms. In order to reduce the possibility of vehicles turning illegally, kerb radii should be kept as low as possible.

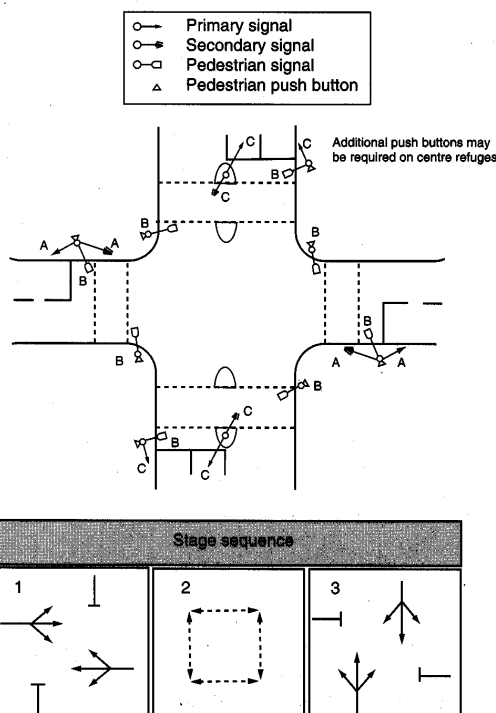

Figure 15 Full pedestrian stage

### STAGGERED PEDESTRIAN FACILITY

**4.44** Where carriageway widths permit, a large island in place of the normal refuge may be provided. Pedestrians can negotiate one half of the carriageway when traffic on that approach is held on red at the junction signals. Normal pedestrian signals are shown during this period. The other half of the road is controlled by separate signals which are located at the opposite end of the island. Normally the stagger should be at least one crossing width in order to alert pedestrians that the crossing is in two sections. A right-hand stagger may reduce junction intergreen times by placing approach stop lines closer to a junction. A left-handed stagger, as shown in figure 16, is normally preferred as pedestrians stepping on to the central refuge will turn towards the approaching traffic stream.

### PEDESTRIAN SIGNAL DISPLAYS

**4.45** Normally each signal face has two lights arranged vertically (the upper red standing man and the lower green walking man) of 300mm nominal diameter. An alternative size of 200mm nominal diameter may be used when specified.

**4.46** The red stationary man, when illuminated by a steady light, indicates to a pedestrian that he should not cross or start to cross the carriageway at the crossing.

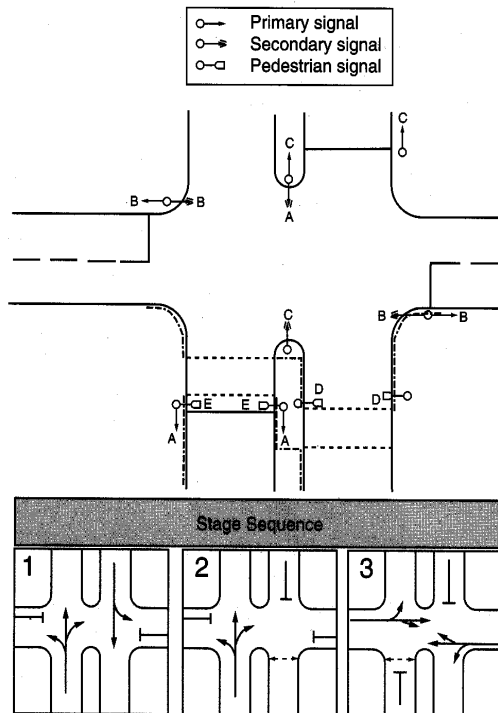

Figure 16 Left-handed stagger stage sequence

4.47 The green walking man signal, when illuminated by a steady light, indicates to a pedestrian that he may cross the camgeway at the crossing.

4.48 The green signal, when illuminated by an intermittent light (flashing green man) indicates that a pedestrian who is already on the crossing should proceed to complete the crossing with reasonable speed; and/or a pedestrian who is not already on the crossing should not start to cross.

### PEDESTRIAN PUSH BUTTONS

4.49 Pedestrian push buttons units mounted on signal posts may be used for calling up pedestrian stages. Additional push buttons are also necessary on wide refuges where pedestrians may be trapped at the end of the pedestrian stage. It is advisable to have push buttons located at each side of the pedestrian crossing, so that pedestrians approaching from either direction can pass a push button before reaching the crossing.

### AUDIBLE WARNINGS

4.50 Audible warnings, in the form of pulsed tones, are intended for the benefit of visually handicapped pedestrians. The set up consists of a post-mounted audible device which emits different patterns of audible signal, representing different pedestrian signal indications e.g. a slow hammering tone during the red standing man period, a quicker

tone for the green walking man period and an intermittent tone for the flashing green period.

4.51 Each proposal for use of audible signals at junctions should be considered on individual merits and carefully checked against real demand, safety aspects and potential risks, technical feasibility of the equipment or supplier, local layout and environment (these signals are not popular with nearby residential blocks of flats).

4.52 An additional benefit to the visually handicapped can be given by fixing metal plates with the street names in Braille onto traffic signal posts in the vicinity of schools or other buildings frequently used by them.

### GUARD RAILS

4.53 It is desirable in some cases to restrict the crossing of pedestrians to certain approaches at an intersection and guard rails can be used to prevent pedestrians crossing at dangerous places (for example where filtering traffic may be moving at times unexpected by pedestrians). Guard rails should always be provided on large islands where staggered pedestrian movements are allowed. Normally minimum length of guard rails provided at each side of a crossing should be 15m.

### PEDESTRIAN SIGNAL SEQUENCE AND TIMINGS

4.54 Pedestrian time should be sufficient to enable pedestrians to cross the full width of the road with relative ease at normal walking speed. An assumed walking speed of 1.2 m/s for the measured crossing distance is satisfactory in determining the minimum times. A staggered crossing can be considered as two separate crossings.

4.55 Normally, minimum green periods of less than 5 seconds are considered too short and are not recommended.

4.56 Provided that the above minimum requirements are met, the green period of a parallel pedestrian stage may be determined by the predominant traffic flow running in parallel.

4.57 **The vehicle clearing times before the start of all pedestrian stages should be checked to ensure that the last vehicle clears the crossing by the time the pedestrian green signal is lit.**

A summary of pedestrian facilities is given in table 3.

### VEHICLE-ACTUATED (V.A.) TRAFFIC SIGNALS

4.58 With vehicle -actuated (VA) signals the duration of the green periods and the cycle time will vary in relation to the traffic flow into and through the controlled area. A vehicle-actuated signal responds to demands recorded for

the various directions of flow. Once a green has been given to a particular direction of flow, the length of green for that direction will be extended until all the traffic has passed through the junction, or the maximum green time for that direction has been reached.

**4.59** Vehicle actuated signals will be most appropriate for isolated junctions where coordination with other signals is not important and for locations with fluctuating light or medium traffic flows.

### STAGE DEMANDS

**4.60** On the approach to a red signal, a green signal will be demanded on the arrival of a vehicle on that approach. This demand is stored in the controller which will serve stages in cyclic order omitting any stages for which no demand has been received. Where it is essential that one stage must always follow another, the appearance of the first stage will automatically insert a demand for the second stage.

**4.61** When a stage loses right of way on a maximum green period change, then a demand is inserted for a reversion to that stage after other demands have been met.

### STAGE EXTENSION

**4.62** When a green signal is displayed, the period for which it is displayed may be extended by vehicles detected moving towards the signal. The purpose of this extension, or the sum of several extensions, is to permit vehicles to pass the stop line before the maximum green period is reached.

### SEMI-VEHICLE-ACTUATED SIGNALS

**4.63** With some semi-vehicle-actuated signals, detectors are installed on the side roads only (i.e. not all approaches) and the right-of-way normally rests with the main road, being transferred immediately or at the end of a preset period to the side road when a vehicle passes over the side road detector. The green period on the side road can be extended in the normal way by successive demands up to a preset maximum. After right-of-way has been returned to the main road, it cannot be taken away from the main road until the preset period has expired.

**4.64** Another modified form of V.A. signals is to operate one or more demand-dependent stages within a fixed cycle time. The demand dependent stages which may consist of vehicle phases (such as right turn traffic, minor flows) or pedestrian phases may be slapped or extended in accordance with the prevailing situation detected. The advantage of this type of control is that a fixed cycle time can be maintained for linking with surrounding controllers.

### TRAFFIC SIGNALS ON HIGH SPEED ROADS

**4.65** When traffic signals are installed on roads where the 85 percentile approach speed at a junction is between 60 km/h and 105 km/h on any arm, drivers have a difficult decision to make when green changes to amber: they are often faced with a choice between attempting to brake to a halt at the stop line, or continuing at the same speed through the junction and clearing it safely.

**4.66** They may fail to achieve either, thus putting themselves and others at great risk.

**4.67** Because of the increased braking distances required at high speeds, drivers need adequate warning that they are approaching a signalled junction. High approach speeds also result in drivers misjudging the lengths of gaps in opposing traffic when making a right turn at the junction -again leading to increased risk.

**4.68** On high speed roads, the use of right turn clearance phases should be avoided. Right turning movement, across high speed flows should be channelized and controlled with a separate vehicle phase, or preferably banned.

### SPEED-RELATED GREEN EXTENSIONS

**4.69** To assist drivers and minimize risk it is necessary to provide green extensions, the extensions being related to the 85 percentile approach speed. Normal approved vehicle detection equipment is used within 40m of the stop line on each approach and in addition approved speed discrimination or speed assessment equipment can be used.

**4.70** Advance warning signs are necessary on each approach, according to local or regional standards.

**4.71** When the 85 percentile approach speed on any arm exceeds 105 km/h it is recommended that traffic signals should not be installed.

### BUS PRIORITY

**4.72** The great majority of passengers in the cities of the developing world travel by bus. Although these road users normally have less political influence than the more affluent car owners, the traffic engineer should consider how to improve bus flows at signalized junctions.

**4.73** The simplest form of priority is to guarantee that saturation on the approaches most used by buses is kept as low as possible, even if this means additional waiting times for the other stages.

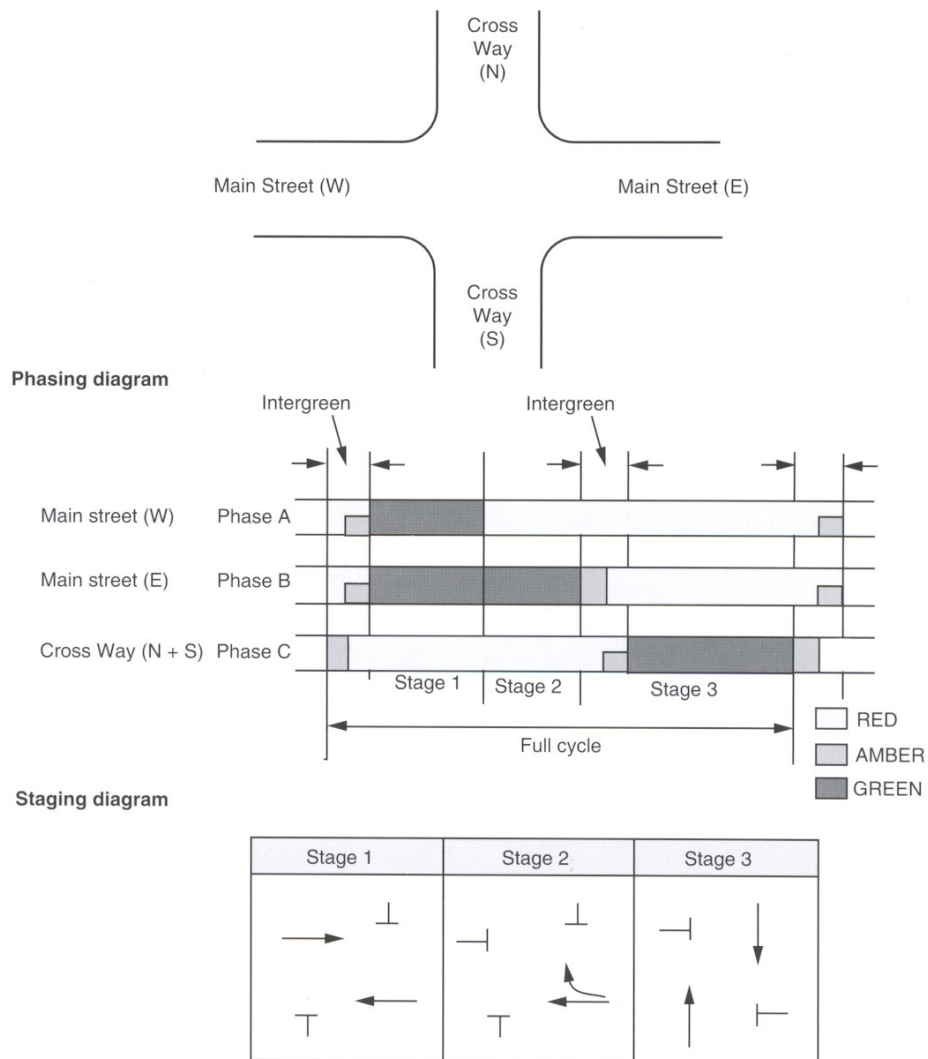

Phasing is denoted by letters, staging by numbers

**Figure 17 Phase and stage sequence for early cut off operation**

**4.74** In ATC systems, the TRANSYT program (see section 7) permits bus flows to be treated separately thus providing optimum settings for buses.

**4.75** Priority to buses, not necessarily within ATC systems has been achieved at traffic signals by a number of methods. These include:

- the selective detection of buses using on-bus transponders and detectors in the approaches to signals;
- the use of segregated lanes, exclusively for buses on approaches to junctions, within which detectors are installed to actuate the signals; and

- the use of pre-signals on the approaches to junctions. These enable traffic queues to be relocated upstream of the junction and control traffic and bus flows to an advance area so that all vehicles are able to clear the junction. (TRL ORN 12, 1993).

**TABLE 3: SUMMARY OF PEDESTRIAN FACILITIES**

Type of facility	Characteristics
No pedestrian signal	<ul style="list-style-type: none"><li>- Traffic signals, even without signals for pedestrians, can help pedestrians to cross by creating gaps in traffic streams.</li><li>- Especially applicable where there are refuges and on one-way streets.</li></ul>
Full pedestrian stage	<ul style="list-style-type: none"><li>- All traffic is stopped.</li><li>- Demanded from push buttons.</li><li>- More delay to vehicles than combined vehicle/pedestrian stages.</li></ul>
Parallel pedestrian stage	<ul style="list-style-type: none"><li>- Combined vehicle/pedestrian stage often accompanied by banned vehicle movements.</li><li>- Useful across one-way streets.</li></ul>
Staggered pedestrian facility	<ul style="list-style-type: none"><li>- Pedestrians cross one half of the carriageway at a time.</li><li>- Large storage area in the centre of the carriageway required.</li><li>- Stagger preferably to face on-coming traffic.</li></ul>
Displaced pedestrian facility	<ul style="list-style-type: none"><li>- For junctions close to capacity.</li><li>- The crossing point is situated away from the junction but within 50m.</li><li>- Normal staging arrangements as above apply.</li></ul>

## 5. CALCULATION OF TRAFFIC SIGNAL TIMINGS - WEBSTER'S METHOD

### CYCLE

5.1 A complete series of stages during which all traffic movements are served in turn is known as a cycle. The cycle time is the sum of each of the stage times.

### INTERGREEN PERIOD

5.2 The period between the end of the green display on one phase and the start of the green display on the next phase gaining right-of-way is known as the intergreen period. It comprises an amber display, red + amber display and may also contain a period when the red signals are shown to all approaches simultaneously. In some countries this intergreen period is composed solely of an amber signal and an all red period. With a five second intergreen the amber and red + amber periods occur consecutively. Any period over five seconds will include a period where red signals are shown to all approaches simultaneously. (an all red period). Safety requirements may dictate a longer period to be given in the following circumstances

- to allow vehicles to clear the intersection when the distance across the junction is excessive.
- to improve safety on high speed roads.
- on roads where there are insufficient numbers of right-turning traffic to justify provision of a separate stage.

5.3 It should be noted that an intergreen period which is too short will be potentially dangerous but a period which is too long is equally unsatisfactory since it may lead to delay, frustration and lack of observation by drivers. A guide to determining the length of the intergreen period is illustrated in Table 4.

5.4 A vehicle which passes over the stop line at the start of the amber display must be clear of the potential collision point in relation to a vehicle starting at the onset of the green of the following stage, when travelling at the normal speed for the intersection. The distances AF and BF should be determined and those distances which give the highest difference used. The recommended intergreen period can then be determined.

5.5 When East-West arms are losing right-of-way if AF-BF is greater than CH-DH, then  $x' = AF - BF$  (or vice versa).

5.6 When North-South arms are losing right-of-way if DE-AE is greater than BG-CG, then  $x' = DE - AE$  (or vice versa).

5.7 When the following stage is a pedestrian stage the

distance 'x' should be determined from the position of the pedestrian crossing. Where pedestrians are losing right-of-way the start of the following stage should be delayed until the crossing area is clear.

### MINIMUM GREEN PERIODS

5.8 Minimum Green Periods cannot be overridden by any demands, whether emanating from vehicles, manual control devices or received remotely from central computers or linked controllers. Such a period is built into signal controllers. The shortest minimum green period normally used for vehicle stages is six to eight seconds.

5.9 Site conditions may require a longer period where large numbers of heavy vehicles have difficulty in starting, or the approach is on a steep gradient.

5.10 Where pedestrians and traffic share the same stage, minimum green times may be governed by the time required by pedestrians to clear the crossing.

### ESTIMATION OF SATURATION FLOW

#### WIDTH OF APPROACH

5.11 The Road Research Technical Paper No. 56 suggested that the Saturation Flow (S) be expressed in terms of passenger car units (pcu's) per hour and with no turning traffic or parked vehicles;

$$S = 525w,$$

where w is the width of the approach road in metres and  $5.15 < w < 18.3$ m.

5.12 For widths less than 5.15 m the following values may be used:

w(m)	2.70	3.00	4.00	4.50	5.15
S(pcu/h)	1790	1850	1950	2250	2700

5.13 Research and experience has shown that S may be more accurately reflected by the number of lanes rather than the overall width of the approach - which tends to underestimate flows in situations where narrow lanes of, say, 2.70m are used.

5.14 The correct value of S can be checked against the formula:

$$S = S_i, (\text{approx. } 1790n - 100)$$

where n = max. no. of lanes (min 2.70m) and  $S_i$  is the value of S for each lane.

5.15 In practical terms this value is about 1790 pcu/h, except for the nearside lane which is 100 units less. The higher value of  $525w$  or  $1790 - 100$  should be used.

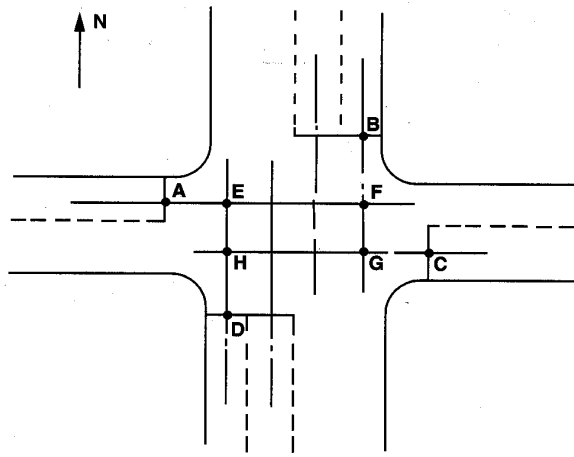

**TABLE 4: CLEARANCE TIMES FOR INTERGREEN CALCULATION**

Ahead Traffic							
Distance 'x' (m)	9	10-18	19-27	28-36	37-46	47-54	55-64
Intergreen (seconds)	5	6	7	8	9	10	11
Turning Traffic							
Distance 'x' (m)	9	10-13	14-20	21-27	28-34	35-40	41-45
Intergreen (seconds)	5	6	7	8	9	10	11

**5.16** Provided that the junction is operating at under 90% of full capacity, the calculated green times or TRANSYT settings will still be valid even if local factors slightly alter the real values of S. However, for key junctions that are operating at capacity there is no alternative but to measure the saturation flow according to TRL Overseas Road Note 11.

#### GRADIENTS

**5.17** For each 1 % of uphill gradient the value of S should be reduced by 3% up to a maximum of 30% reduction. For downhill gradients another 3 % should be added to the value of S (up to a max. of 15%) for every 1 % of gradient.

#### TRAFFIC COMPOSITION-PASSENGER CAR UNITS

**5.18** The effect of different vehicle types on the saturation flow is eliminated by transforming all vehicles into standard car units, using a conversion factor, such as the values suggested in Table 5.

**5.19** The figures shown in Table 5 give an idea of the range of values for different vehicle types in a number of countries. The suggested values represent typical conditions in developing cities, where heavy goods vehicles are normally larger than in Europe or Japan. The value for an

urban bus also assumes a vehicle of 10-12m. For motor cycles, the lower value suggested would reflect a high proportion of smaller types of vehicles, (under 125cc).

**5.20** It is worth remembering that although there has been a lot of discussion on the changes of the value of S due to smaller, faster cars, etc., these factors tend to act equally on all the approaches of a junction.

#### TURNING TRAFFIC

**5.21** When this traffic has an exclusive lane with no opposing flow, S may be given by the formulae:

$$S = \frac{1800}{1+1.515/r} \quad (\text{for one lane})$$

$$S = \frac{3000}{1+1.515/r} \quad (\text{for two lane})$$

where r = av. radius of turn

**5.22** In mixed traffic each left turning vehicle is equivalent to 1.25 straight ahead vehicles, and each right turning vehicle is equivalent to 1.75 straight ahead vehicles.

**TABLE 5: SOME TYPICAL PCU VALUES AT URBAN INTERSECTIONS**

vehicle type	England 1966	France 1974	Japan 1974	Indonesia 1984	India -	Cairo 1985	Chile 1984	Suggested Values
Car	1.0	1.0	1.0	1.0	1.0	1.0	1.0	1.0
Mini-bus <20pass.	1.0	-	-	1.25	-	1.0	1.26	1.25
Motor Cycle	0.33	0.3	0.33	0.2	0.25	0.5	0.64	0.3
Heavy Goods	1.75	2.0	1.75	2.25	2.8	1.6	2.23	2.5
Bus>20pass.	2.25	2.0	1.75	2.62	3.6	2.5	1.52	2.5
Auto Rickshaw	-	-	-	0.52	0.6	-	-	0.5
Pedal Rickshaw	-	-	-	0.93	1.4	-	-	1.0
Pedal Cycle	-	0.3	0.2	-	0.4	-	-	0.3
Horse &Cart	-	-	-	-	2.6	4.0	-	3.0
Bullock Cart	-	-	-	-	11.2	4.0	-	-

**PARKING, WAITING AND BUS STOPS**

**5.23** A parked car on an approach causes an effective loss in width, which can be expressed as:

$$\text{loss} = 1.68 - \frac{0.9(z - 7.62)m}{g}$$

where z (>7.62) is the distance from the stop line of the parked car and g the green time in seconds.

**5.24** In practice, the handling of parked or waiting vehicles in developing cities is extremely complex and involves a lot of assumptions on the part of the engineer. Traffic signals are generally put on the busiest junctions - and these are exactly the favorite street corners for commerce and irregular bus stops.

**5.25** Road signs and road markings may prohibit parking, but enforcement is normally difficult or ineffective. In most cases the engineer will be left with the choice of reducing the effective carriageway width by 1m (for the odd parked car, a bus stop or loading), by 2m (a row of parked cars with some double parking and occasional bus stop) or even 3m (next to a school where double parking is almost the rule) - or in situations such as the street market shown in Plate 2.

**5.26** One of the other main causes of reduced saturation flow is the proximity of a signal controlled junction down-stream. This may result in the need for vehicles to slow down because of poor linking or vehicles backing up from another congested signalized junction downstream. The adverse effect of adjacent signals on one another can be particularly serious during peak hours. In these circumstances site observations should be made to evaluate the actual effective green usable by various vehicle phases and to determine the necessary adjustments on signal timings i.e. green splits and offsets.

**TIME SETTINGS**

**TOTAL LOST TIME PER CYCLE (L)**

**5.27** With a 2 second red/amber start and 3 second amber finish, the Inter-green Period for two conflicting stages is 5 seconds plus any all red time.

**5.28** The lost time for a single phase during the green and amber period is normally about 4 seconds, in other words, the effective green time is thus the green time + 1. Then, per cycle:

$$\text{Total lost time} = 4 * \text{number of stages} + \text{all red}$$

**5.29** Full pedestrian stages should be treated as all red times and included for the calculations.

**FLOW FACTORS**

**5.30** The flow factor 'y' for each phase is given by the formula:

$$y = \frac{\text{design flow for an approach (q)}}{\text{saturation flow for an approach (S)}}$$

**5.31** Where more than one approach is operating during a phase, the maximum 'y' should be used. Where an early cut-off or late start is to be used in connection with a right turn the 'y' values for the right turn and for the approach with shortened time should be added together to represent one phase, unless the straight on traffic on the same approach as the right turn has a higher value, in which case this latter figure should be taken.

**5.32** The sum of these higher 'y' values for all the phases is the 'Y' value, which is in fact a measure of the congestion, and which will be used for calculating the optimum signal setting.

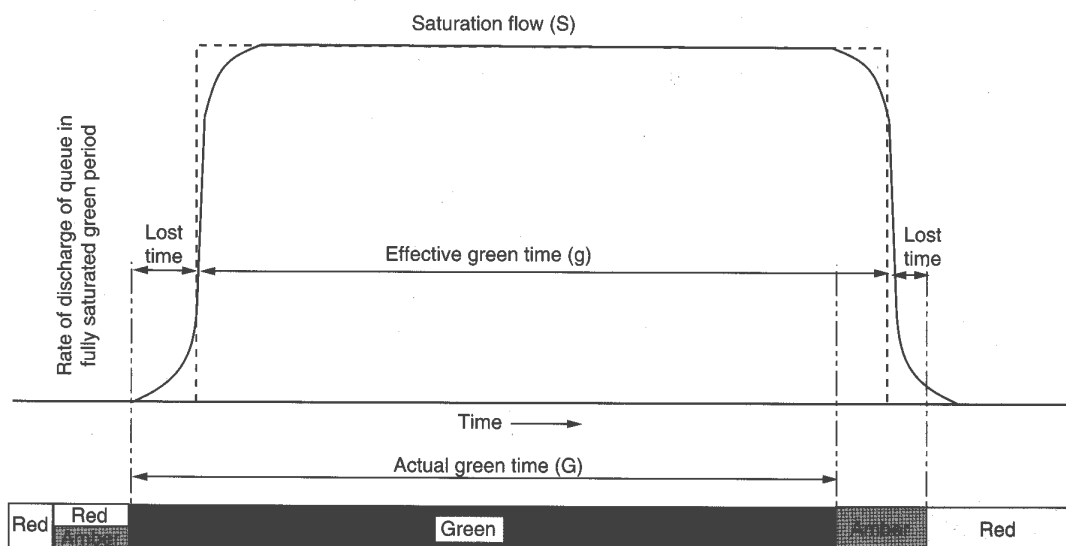

Figure 18 Variation with time of discharge rate of a queue in a fully saturated green period

### CYCLE TIMES

5.33 For an isolated signal installation, where the mean traffic level is constant and where vehicle arrivals are at random, the U.K. Transport Research Laboratory (TRL) has shown that the optimum cycle time for minimum delay ( $C_o$ ) is given by:

$$C_o = \frac{1.5L + 5}{1 - Y} \text{ secs.}$$

5.34 The cycle time which is just sufficient to pass the traffic ( $C_m$ ) is given by:

$$C_m = \frac{L}{1 - Y} \text{ secs.}$$

5.35 This is the minimum possible cycle time which may be associated with excessively long delays. In designing linked signals a cycle time should be chosen which provides a margin over this minimum cycle time for the key intersection.

5.36 In practice it will be generally appropriate to choose a practical cycle time ( $C_p$ ) which will allow the installation to be loaded to 90 per cent of its capacity:

$$C_p = \frac{0.9L}{0.9 - Y} \text{ secs.}$$

5.37 Where pedestrian crossing volumes are high it will be desirable to use as short a cycle time as practicable to minimize delays imposed on pedestrians. In these cases, recommended practice normally limits cycle times to below 90 seconds. Cycle times lower than 50 seconds, on the other hand, tend to waste too much of the cycle time in lost time.

5.38 Even when pedestrian movement are low, a practical upper limit to cycle times is around 120 seconds.

### GREEN TIMES

5.39 Signal setting for the effective green periods ( $g$ ) should be in proportion to the  $y$  values on each approach, with an allowance for lost time:

$$\frac{g_1}{g_2} = \frac{y_1}{y_2} \text{ etc.}$$

$$g = \frac{y(c - L)}{Y}$$

Where:

$g$  = effective green period

$y$  = flow factor

$G$  = actual green period

$c$  = cycle time

$L$  = total lost time

$Y$  = sum of  $y$  factors

$c - L$  = total effective green time

Therefore:

$$g_1 = \frac{y_1(c - L)}{Y}$$

$$g_2 = \frac{y_2(c - L)}{Y}$$

5.40 To simplify the calculations, for most cycle times of around or above 60 seconds, the same value can be used for



both G and g. In other words, if the total lost time for the junction is 8 seconds and the desired cycle time is 60 seconds, both G and g can be taken as 52 seconds.

**5.41** If parallel pedestrian facilities are included in the junction method of control, the minimum green times for the minor movements could well be dictated by parallel pedestrian crossing green times. This could distort the green split calculation and in situations where pedestrian signals are being introduced the engineer is faced with the dilemma of either reducing the minimum pedestrian time or oversaturating the junction capacity, in turn leading to disrespect of the pedestrian signal. In many developing cities this problem still remains.

### DEGREE OF SATURATION

**5.42** Degree of saturation (X) for individual approaches may also be expressed as;

$$X = \frac{qc}{gs}$$

where:

q = design flow  
 c = cycle time  
 S = saturation flow  
 g = green time for approach

**5.43** The degree of saturation should be the same for all the predominant arms of an intersection when the signal timings are at optimum settings and is given by the equation:

$$X_o = \frac{2Y}{1 + Y}$$

### JUNCTION CAPACITY ANALYSIS

**5.44** The ultimate capacity of an intersection may be defined as the maximum flow which can pass through the intersection with the same relative flows on the various approaches and with the existing proportions of turning traffic. Capacity will normally increase as the cycle time increases, since the ratio of lost to useful time decreases. In practice, for maximum reserve capacity assessment, a maximum cycle time of 120 seconds should be adopted. However it should be noted that for new installations, the maximum operating cycle time should be limited to about 90 seconds.

### TRAFFIC SIGNAL CALCULATION SHEET

**5.45** A 'Traffic Signal Calculation Sheet' is shown as an aid for performing traffic signal calculations.

**5.46** Most of the useful formula have been incorporated so that the engineer may perform the operations directly, without referring back to this guide. This particular model was composed using a spreadsheet and can be adapted according to local conditions and the program most suitable.

### STAGE/PHASE SEQUENCE DIAGRAM

**5.47** The method of signal control should be fully illustrated by the Stage/Phase Sequence diagram, complete with the following details:

- diagrammatic junction layout
- signals operation sequence
- design flows in pcu/h
- pcu. factor (if necessary), for converting unclassified counts from veh/h to pcu/h
- intergreen periods required
- actual green times (G = g - 1 )

**5.48 All traffic signal calculations should be regarded as a good first estimate. There is no substitute for on-site checks and the 'fine tuning' that should take place once the changes or installations have been implemented.**

**5.49** This section has outlined the "Webster" method of traffic signal design, which, although manual, has great merit in that it is simple to apply and enables a clear understanding of the principles used. However, there have been great advances in PC based programs for signal design, such as TRANSYT, OSCADY, LINSIG, and others which enable calculations to be canned out rapidly and accurately.

### CHECK LIST FOR SIGNAL DESIGN

#### Step 1 - Identify Traffic Flow Volumes

Traffic flow volumes are identified, including turning movements.

#### Step 2 - Identify Junction Layout, Lane Geometry and Site Characteristics

The junction layout, including lane geometry and site characteristics are identified.

It may be necessary, if revealed in Step 4 or Step 7, to modify the layout to cater for turning movements, pedestrians or to enhance capacity and/or safety.

#### Step 3 - Identify Signal Phasing and Method of Control

The method of control to be used for analysis is identified.



#### **Step 4 - Check Turning Movements and Pedestrians**

Adequate provision for turning movements and pedestrians should be checked. It may be identified at this stage that the assumed method of control would need adjustment before continuing.

Adequate allowance in calculations for parallel pedestrian minimum green crossing times should be made.

#### **Step 5 - Estimate Saturation Flows**

The saturation flows for various approaches/movements are identified. In critical cases the saturation flows for important movements may have to be measured on site.

#### **Step 6 - Compute Y, L,**

The lost times, flow factors and sum of the critical flow factors are computed.

#### **Step 7 - Compute Reserve Capacity**

The maximum reserve capacity of the intersection is then calculated as a measure of operating performance. If this is not satisfactory, then it may be necessary to go back to Step 2, modify data and layouts and recalculate. A minimum provision of 25% reserve capacity should be provided wherever possible for new junctions. A lower standard may be adopted for existing junctions where further improvement is restricted by space limitations.

#### **Step 8 - Compute Co, Cm, and Cp.**

The optimum, minimum and practical cycle times for operating the junction are then computed for further analysis, if necessary.

#### **Step 9 - Select C**

It is then necessary to select a cycle time for operating the intersection. Sometimes, for reasons of linking, the selected cycle time may be different from the values calculated in the previous step.

#### **Step 10 - Compute Green Times, Degree of Saturation**

The green times of the various phases are then computed. Degree of saturation may be computed as well if detailed analysis of signal operation is required. If good linking to other junctions requires a cycle time that results in very low degree of saturation and a very high reserve capacity, consideration should be given to double cycling this junction within the linking group, i.e. running it at half the linking cycle time.

#### **Step 11 - Determine Offset and Other Controller Settings**

Offset and other controller settings such as minimum green, maximum green, etc. are then finalized. Offsets for linking signals may be prepared with the aid of time-distance diagrams. or programs such as TRANSYT. (see section 6).

#### **Step 12 - Prepare Documentation**

For record purposes, drawings showing the junction layout, method of control, stage/phage diagram, traffic flow, etc. need to be prepared and maintained. Standard symbols should be used wherever applicable.

**Step 0 - The Proven Need for traffic signals at the junction according to approved warrants, should always come first and be part of the documentation.**

## 6. COORDINATION AND LINKING OF TRAFFIC SIGNALS

6.1 Many cities in the developing world have grown to huge dimensions in a very short period and lack the large scale road infrastructure needed for modern traffic, as well as the capital to build it. This leads to the inefficient use of the existing road network, often in the form of extensive one-way systems, in turn leading to the need for a large number of traffic signals - mostly fairly close to one another.

6.2 The effect of vehicles stopping at a signalised junction is to form the vehicles into a queue behind the stop line. When this queue is released as the green is given, it will discharge initially at its maximum rate (i.e. saturation flow) and move forward as a 'platoon'. If, as this platoon approaches another signal controlled intersection, its arrival is made to coincide with the start of the green period, the vehicles will experience no delay at this new junction. If the platoon has to stop, a queue may form leading to spillback, which in turn may block the upstream junction.

6.3 The objectives of coordination of signals are to:

- prevent the queue of vehicles at one intersection from extending back and interfering with an upstream junction.
- increase the capacity of the linked route.
- enhance driver comfort by offering less stops and smoother flows in a controlled manner.
- offer minimum overall delay for road users, reducing overall travel time.
- reduce fuel consumption - and hence pollution - within the area.
- impose on drivers a safer behaviour, as they normally bunch together at the speed designed for green coordination (or waves). Speeding is thus minimized, accident risk and severity are reduced as is the associated risk for pedestrians, as they can judge oncoming speeds with greater accuracy.

### SIMPLE PROGRESSIVE SYSTEM (GREEN WAVE)

6.4 The most commonly-used linking system works with a cycle time common to all intersections and the signals are so timed that the 'go' periods are staggered in relation to each other according to the road speed to give a 'progression' of green periods along the road in both directions. Thus road speed should be considered "reasonable" by drivers; if speeding is common before linking, then a measured speed will be too high for safe operation. In this

case, a desired speed should be used to ensure that the platoon conforms to the legal limit.

6.5 The timings of the signals in a simple progressive system can be prepared with the aid of a time-distance diagram, examples of which are shown in figures 19 and 20.

6.6 On these diagrams, distances between junctions along the route are plotted along the abscissa (y axis) and the travel times are plotted along the ordinate (x axis). The slope of diagonal lines represent the chosen speed of progression and green stages of successive junctions are offset in time. Normally the problem is one of determining, by trial and error, the optimum through-band speed and width for a fixed cycle time. For one-way roads, the green bands follow each other in sequence. The driver, having passed one intersection, will then receive right of way at the others.

6.7 When the flow of traffic is two-directional and where the intersections are not equally spaced, the situation is more complex and it may be necessary to come to a compromise on progression between the two directions. It may also be necessary to take into account other requirements such as demands from cross-street traffic.

6.8 The time-distance diagram method can be used to bias in favour of a particular direction of flow e.g. to favour a heavy inbound flow in the morning peak at the expense of increased delay to the fewer vehicles travelling in the opposite direction. The situation may be reversed for the evening peak.

6.9 Cycle time for a coordinated signal system is normally dictated by the timings of a key junction, i.e. the junction which is most heavily loaded. Spare green time should be allocated as required to clear traffic turning into the main route from side roads in order not to delay the through platoons.

6.10 To minimize congestion, opportunities for leaving the system should also be greater than for entering.

6.11 In heavy city centre traffic a design 'speed' of about 10m/s ( about 40km/h) usually gives good results. For suburban traffic, where traffic is lighter and signals are about 300m apart, a design velocity of 15m/s (about 60km/ h) can be used as a first estimate, provided this does not conflict with local speed restrictions.

6.12 On two-way roads, good coordination can usually be obtained by using a common cycle time equivalent to twice the average travel time between junctions.

6.13 For example, using a design speed of 10m/s on a two-way road between nodes A.B.C, with links lengths AB+ 260m and BC = 300m. The travel times are then 26 and 30 seconds with an average of 28s. A good estimate of cycle time would then be  $2 \times 28 = 56$  seconds, or in practice a cycle time of 55 to 65 would be adequate (with the lower option possibly leading to higher speeds).

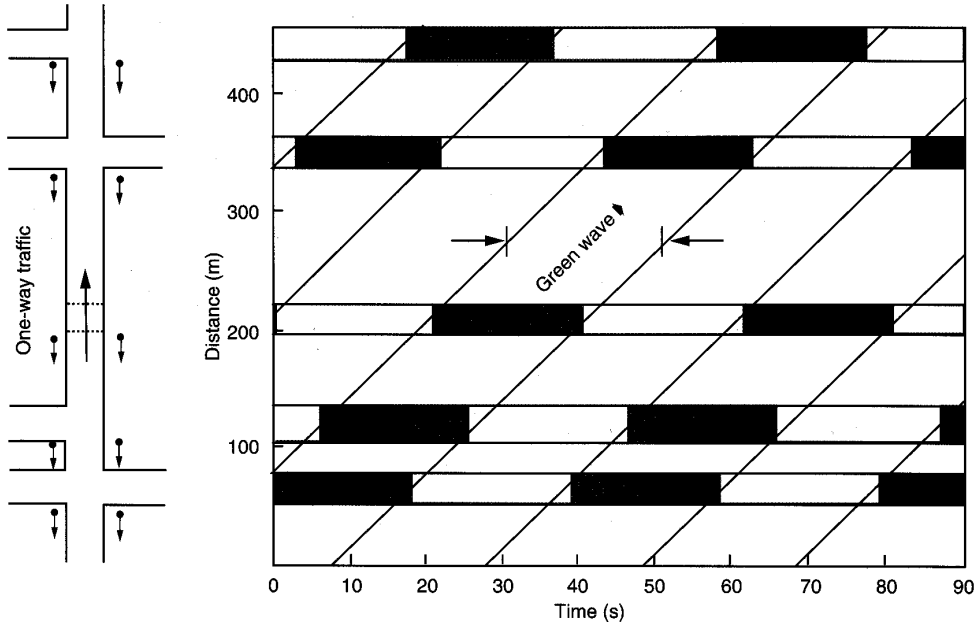

Figure 19 Co-ordinated signals for one-way traffic

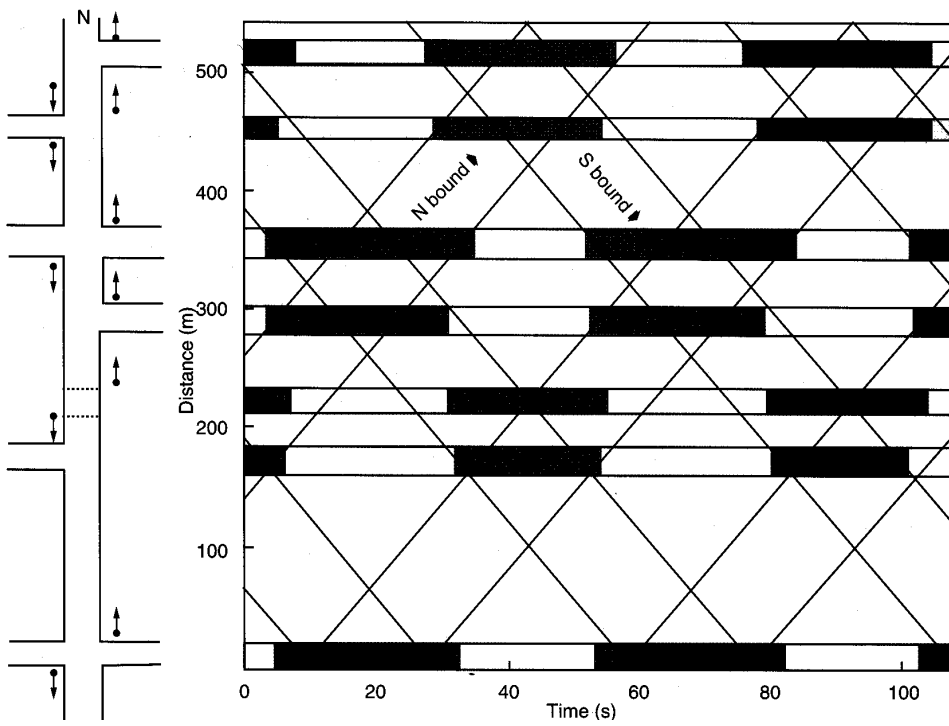

Figure 20 Co-ordinated signals for two-way traffic

- Red (amber omitted, only north-south phase shown)
- Green

## MECHANISMS FOR LINKING SIGNALS

### CABLE-LINKING

**6.14** Local traffic signal controllers at intersections working in a linked group may be cable-linked to a master controller. The master controller generally ensures that the local controllers, or 'slave controllers' as they are termed, operate in synchronization by sending control pulses or instructions down the link cable to every slave controller.

### CABLE-LESS LINKING

**6.15** Linking of signals may also be achieved by cable-less means such as radio, mains synchronization, etc. Originally conceived to offer the benefits of wide area coordination while avoiding the expensive costs of underground ducting, these systems are now less competitive than the simpler ATC systems, as they do not allow for supervision of faults or such basic Responsive System facilities such as queue control.

### FIXED-TIME COORDINATED SIGNALS

**6.16** These systems are based on assumptions that traffic flows are repetitive over a weekly (24h, 7day) cycle and that the appropriate predetermined signal settings can be prepared to cope with predictable traffic flows. The traffic plans, or signals settings can be selected according to the day of week and time of day. These systems require controllers with synchronized internal clocks and, typically, a minimum of 6 plans to choose from.

**6.17** These would normally include plans for the:

- Morning Peak.
- 
- Off Peak (work day).
- 
- Evening Peak.
- 
- Off Peak (night, holiday or Sunday).
- 
- Nighttime Yellow Flashing, etc.

### AREA TRAFFIC CONTROL (ATC)

**6.18** Area Traffic Control, (ATC) is the centralized control of traffic signals on an area-wide basis using micro-processor and computer technology.

**6.19** Usually the traffic controllers on street are linked to one or more central computers in the control centre, via data transmission cables. The cable network can either be provided as a dedicated network or private circuits leased from the telephone company (or a mixture of both, according to cost). Urban Traffic Control, (UTC) involves central coordination of signals as an ATC, but will include other facilities such as car park space control and variable message signing.

**6.20** The main facilities provided by ATC Systems are

- **Optimized signal coordination.** With the aid of centralized computer control, signal settings can be optimized on an area basis to provide minimum overall delay and reduced journey times.
- **Control flexibility.** Changing traffic conditions can be catered for by vehicle actuation or predetermined multi-plan operation. The time settings of traffic signals can also be altered very quickly by manual intervention at the control centre, such as modifying the existing signal timing plan or replacing it with a new plan.
- **Fault monitoring.** One of the most important facilities offered by ATC systems is the continuous monitoring of the operation of the traffic signal equipment linked to the computer. Any fault condition detected is reported to the Control Room immediately and fault repairs can be carried out quickly.
- **Priority for emergency and public transport vehicles.** For fire engines which always start from a certain fire station, special plans may be prepared for predetermined 'preferred routes' and stored in the central computer. Priority arrangements can be given to public transport routes, busways, etc.
- **Accident reduction.** ATC systems improve road safety, especially in the traffic conditions of some developing cities. Table 6 shows some results of traffic accidents before and after the construction of an ATC system.

**TABLE 6: ACCIDENTS IN ATC SYSTEMS**

ATC System	Accident Reduction (%)
Toronto	13
Atlanta	24
Witchita Falls	8.5
Sydney	20
Glasgow	14
Paramatta	8
West London	18
Rochester	20
Curitiba	24

**6.21** On certain corridors these improvements may be even greater. For a well designed system on downtown streets together with suburban corridors, an accident reduction of about 20% (all types) may be expected.

## FIXED TIME ATC SYSTEMS

6.22 These ATC systems operate on a strategy of fixed time traffic signal plans for each controller. Signal timings and plans for junctions alter in accordance with a preset timetable held in the central computer or in a microprocessor inside the controller itself. These systems work very well for traffic patterns which are predictable and which change quite slowly. Traffic signal timings are developed from historical traffic flow data collected for the junctions and the timings require updating periodically, depending on the traffic fluctuations at each site.

6.23 For large urban areas with possibly several hundred traffic signal controlled intersections, a large system, complete with a special computer, monitor rooms and possibly closed circuit television is an entirely appropriate arrangement. Usually this type of maxi system will demand (and can justify) its own dedicated team of hardware and systems engineers, traffic engineers and technicians and system operators.

6.24 For medium-sized cities in the developing world, however, the benefits accruing from the installation of a maxi system cannot be justified in terms of the initial costs and staff resources demanded to run it. Experience has revealed that fixed time systems are cheap and simple to install and maintain and recent developments in electronic technology have made the Mini ATC, or Compact ATC systems almost as efficient as the traditional 'centralized' systems. The features of these systems are fairly standard, and can be summarized as:

- Computer and data transmission system in a stand-alone unit which does not require a specially controlled environment.
- "off the shelf" system operating software.
- automatic printout of faults; can be left to run virtually unattended.
- usually these systems are purchased as a complete package to a standard specification. This minimizes the staff input at the outset of the scheme.

6.25 Standardization usually means that the costs involved to the purchasing of such a system are modest. As the system requires no special architectural/environmental arrangements, and will virtually 'run itself,' the staff input on the part of the purchaser/local administration is also small. Much of the flexibility and monitoring facilities of the maxi systems are, however, maintained and signal timings can be kept up to date by a small team, possibly on a part-time basis in addition to normal traffic engineering duties.

**6.26 One of the major difficulties and costs of ATC systems is in installing an adequate data transmission network. This item should be given special attention,**

**examining all possible alternatives, during the evaluation of any ATC or UTC system.**

## SEMI-RESPONSIVE SYSTEMS

6.27 To overcome some of the rigidities inherent in the fully fixed time strategy, whilst avoiding some of the sophistication and complexities of fully responsive strategies, some degree of traffic responsive control can be introduced into the fixed time philosophy.

6.28 This can take two main forms

- Using strategic detectors to detect fluctuations in traffic flow, the system automatically changes from one fixed time traffic plan to another. Basically, this is equivalent to the introduction of a flexible timetable into the system.
- Installing vehicle presence detectors and pedestrian push buttons at junctions and introducing a VA 'window' into the traffic signal timing plans. The difficulty with fully traffic actuated signals is that the concept of signal linking within a fixed cycle time breaks down under fully traffic-actuated control. The VA-window concept allows a certain amount of 'local discretion' in the traffic signal plan. This permits the controllers at certain times in the signal cycle to decide whether to introduce a certain stage or whether to remain on the stage running, or to control the extension of queues by allowing for green extensions, etc.

6.29 The former is very effective in overcoming difficulties in defining accurately plan change points. Also, as only a relatively small number of detectors may be required, a heavy ongoing maintenance commitment on detectors is unnecessary. And in developing cities detectors are often a problem.

6.30 The second type of system can be very effective in coping with minor fluctuations in traffic flow, queues and with the problems of light vehicle and pedestrian flows in the off peak period. Though semi-responsive systems do require more complex signal controllers on street.

## FULLY RESPONSIVE CONTROL

6.31 The logical extension of computerised traffic control philosophy is the fully automated system, where the computer automatically calculates and adjusts signal timings to suit actual traffic conditions on street.

6.32 The SCAT (**Sydney Coordinated Adaptive Traffic**) System is based on a limited distributive intelligence system with a main computer performing certain monitoring functions and several satellite computers controlling a group of controllers on street.

6.33 All intersections within a subsystem operate on a common cycle length and are equipped with inductive loop vehicle detectors on all approaches. These are located in

each lane immediately in advance of the stopline and perform the dual functions of providing traffic flow data for strategic control and local or 'tactical' vehicle actuation.

**6.34 The SCOOT (Split Cycle Offset Optimization Technique)** System consists a number of SCOOT cells or computers, each cell being able to control up to 60 junctions, handling input data from up to 256 vehicle counting detectors on street. Unlike the SCAT system, the SCOOT detectors are placed as far upstream from the approach to the junction as possible and are then calibrated to strike a balance between flow and occupancy.

**6.35** In normal operation SCOOT estimates whether any advantage is to be gained by altering the timings. If an advantage is predicted then one or more of the timings are changed by small amounts. By this means frequent, but small, changes allow the signal timings to match fluctuations in traffic demand. There are no large and abrupt changes in signal timings, although overtime, major changes in splits, cycle time and offset can occur.

**6.36 It must be remembered that in order to operate any fully responsive system at least 80% of detectors need to be fully operational. This requires constant maintenance and adequate continuous funding –exactly the areas which are often a problem for transport projects in the developing world.**

**DUET – DIAL-UP EQUIPMENT TESTING**

**6.37** It is arguable whether the greater benefit obtained from an ATC system is derived from signal coordination or from the ability to monitor continuously the performance of signal equipment. For signals in remote locations or where the cost of a dedicated ATC telecommunication network is not justified, DUET may provide a compromise solution. With the aid of this technology the equipment can be interrogated over public telephone lines as and when necessary.

**6.38** Each local controller is connected to the public telephone system. Communication is achieved by dialing a telephone number from the Central Office, which connects the local controller via modem to equipment in the Central Office for testing/fault reporting purposes.

**6.39** This arrangement avoids the need for a dedicated private circuit but provides only a limited fault monitoring facility as equipment faults will only be detected when the interrogation takes place, which may be some time after the fault has occurred.

**6.40** An alternative is for the local controller to have the ability to 'ring-up' the Central Office when a fault is detected. At the same time, it should be possible to change and load plans from the Central Control Room via a DUET setup.

**6.41** The curve shown in figure 21 represents the cost-benefit relationship for the various options of control out-lined in this section. It should be noted that the principal gains are obtained with less complex measures and that high-tech solutions - although extremely useful options in big cities - are normally only recommendable as a final stage in the ongoing process of traffic signal improvements.

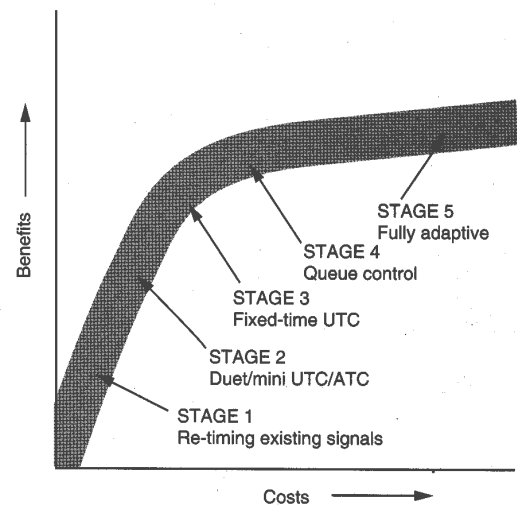

**Figure 21 Cost/benefit relationship for different types of signal co-ordination**

## 7. THE TRANSYT PROGRAM

7.1 The TRANSYT program was developed by the U.K. Transport and Road Research Laboratory in a series of experimental applications in Glasgow, Scotland, where an ATC System had been installed.

7.2 The network being modelled in TRANSYT is represented by 'nodes' inter-connected with 'links'. Each signalised junction is represented by a node; each distinct one-way traffic stream leading to a node is represented by a link. TRANSYT takes the flows on each link and models traffic behaviour from this.

7.3 Figure 22 represents a small network of three junctions together with the traffic flows for one of the peak hours.

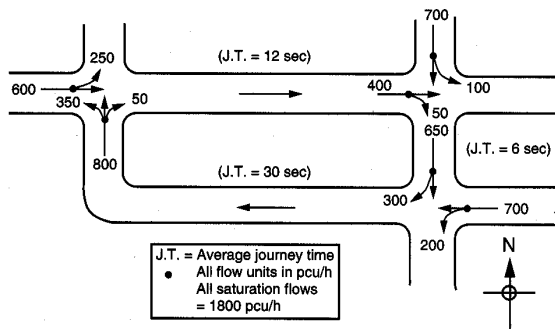

Figure 22 Simple road network and traffic flows

7.4 This is then transformed into a "TRANSYT Diagram" such as figure 23; note that turning movements are given separate link numbers.

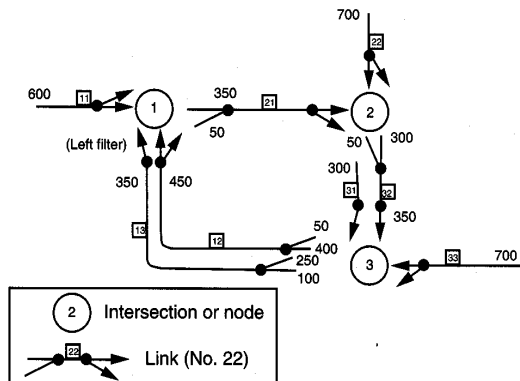

Figure 23 Transyt diagram of the network

7.5 TRANSYT requires the user to input a variety of information about the network. The data required is basically of four types; network data, signal optimisation data, link data, and node data. Network data includes such things

as the common cycle time for the network and the cost of delays to vehicles. Signal optimisation data allows the user to specify what type of optimisation is to be carried out. Link data requires the user to specify information such as the flow and saturation flow on a link, as well as during which stages the link receives a green signal. The node data requires the user to specify the staging of the signals at each node, minimum greens and intergreens.

7.6 This data is resumed in the input table as follows:

90 SECOND CYCLE 30 STEPS							
FINAL SETTINGS OBTAINED WITH INCREMENTS :- 13 36 -1 13 36 1 -1 1							
- (SECONDS)							
NODE NO	NUMBER OF STAGES	STAGE 1	STAGE 2	STAGE 3	STAGE 4	STAGE 5	STAGE 6
1	2	33	89				
2	2	37	87				
3	2	7	48				
4	2	58	27				

7.7 TRANSYT will produce an optimised set of signal timings for each node within a network. The signal timings are calculated by a method which works by varying both the signal offsets and the duration of the individual stage green times. Together, these signal timings result in delay being reduced to a minimum within the network.

7.8 The program can also be used to advise on the best cycle time for a network. This area of TRANSYT will also advise the user about the benefits to be gained from double-cycling any of the nodes.

7.9 For the optimised signal timings calculated by TRANSYT, a table of results, relating to performance and delay on each link, is given. From this table the user can deduce how saturated each link is, the potential size of any queues, the cruise time for vehicles, the amount of delay each vehicle can expect to suffer, as well as a series of cost related indices in terms of fuel consumption and delays.

7.10 This program has been immensely successful and is recognized as one of the most important traffic signal tool available to engineers. Versions are now available for use in P.C.'s and these also allow increased emphasis to be attached to key links in the network and the whole process can, if desired, be biased either towards minimum delay or minimum stops to vehicles. The average speed within the network and total fuel consumption are also given and these provide the basic data for evaluating the operating benefits to be gained from a new plan or system. Special routines are also available to model bus movements separately and aid in the selection of optimum cycle times.

7.11 In practice, the TRANSYT Performance Index may be improved in "Grid" type networks by building into the initial offsets simple green waves on the main streets of the network. The output is then normally a much improved version of the desired coordination. If left to optimize from an all zero setup, the program may opt, when signals are close together, for a solution of the 'open all lights north-south, then east-west'. This leads to speeding as drivers note that all the lights along the road go green at the same time.

**TABLE 7: TRANSYT OUTPUT FOR A SIMPLE NETWORK**

LINK NUMBER	FLOW INTO LINK (PCU/H)	SAT FLOW (PCU/H)	DEGREE OF SAT (%)	MEAN TIMES PER PCU CRUISE DELAY		-----DELAY----- UNIFORM RANDOM+ COST OVERSAT OF DELAY			-----STOPS----- MEAN COST OF STOPS		-----QUEUE----- MEAN AVERAGE EXCESS		PERFORMANCE INDEX. WEIGHTED SUM OF ( V VALUES (S/H)	EXIT NODE	GREEN TINES START START END			
				(SEC)	(SEC)	(U+R+O.HEAN Q)	(PCU-H/H)	(S/H)	/PCU (%)	(S/H)	(PCU)	(PCU)			1ST (SECONDS)	2ND	ENE	
10	1200	2400	87	10	25	5.3	+	3.1	(68.1)	86	(9.9)	27	+	77.9	1	38	89	
11	550	35005	81	8	31	3.6	+	1.2	(38.7)	98	(5.2)	24		43.8	1	4	33	
12	400	11L	81	8	24	1.7	+	0.9	(21.3)	94	(3.6)	24		24.9	1	4	33	
20	1150	2600	87	10	29	6.2	+	3.1	(74.6)	91	(10.0)	28	+	84.5	2	42	87	
21	1101	38005	86	12	31	7.2	+	2.4	(77.3)	87	(9.1)	31		86.4	2	2	37	
22	199	21L	86	12	39	1.7	+	0.4	(17.4)	108	(2.1)	31		19.4	2	2	37	
30	500	1600	76	10	34	3.2	+	1.6	(37.9)	92	(4.4)	12		42.2	3	12	48	
31	1000	36005	67	13	11	2.2	+	0.8	(24.1)	38	(3.7)	13		27.8	3	53	7	
32	200	31L	67	13	5	0.1	+	0.2	(2.4)	22	(0.4)	13		2.8	3	53	7	
39	100	1600	15	10	20	0.5	+	0.1	(4.4)	61	(0.6)	2		5.0	3	12	48	
40	800	1600	82	10	23	3.0	+	2.2	(42.0)	80	(6.1)	18	+	48.1	4	63	27	
41	550	3200S	73	10	27	3.1	+	1.0	(33.1)	90	4.73	17		37.8	4	32	58	
42	150	41L	73	10	16	0.4	+	0.3	(5.3)	81	(1.2)	17		6.5	4	32	58	
49	100	1600	10	10	9	0.2	+	0.1	(2.1)	40	(0.4)	1		2.5	4	63	27	
TOTAL DISTANCE TRAVELLED		TOTAL TIME SPENT		MEAN JOURNEY SPEED		TOTAL UNIFORM DELAY		TOTAL RANDOM+ OVERSAT DELAY		TOTAL COST OF DELAY		TOTAL COST OF STOPS		TOTAL PERFORMANCE INDEX				
(PCU-KH/H)		(PCU-H/H)		(EM/H)		(PCU-H/H)(PCU-H/H)		(S/H)		(S/H)		(S/H)		(S/H)				
843.0		79.8		10.6		38.2		17.5	(448.6) + (		61.2)		( 0.0)	509.8				TOTALS
*****																		
FUEL CONSUMPTION PREDICTIONS				CRUISE LITRES PER HOUR		+		DELAY LITRES PER HOUR		+		STOPS LITRES PER HOUR		=		TOTALS LITRES PER HOUR		
				59.7				78.0				60.7				198.3		

NO. OF ENTRIES TO SUBPT = 10  
 NO. OF LINKS RECALCULATED= 115

## 8. SYSTEM AND ECONOMIC ANALYSIS OF TRAFFIC CONTROL

**8.1** In many cities throughout the developing world there is enormous scope for introducing modern traffic controllers capable of offering linked signal timings compatible with the different traffic volumes found during the day. The TRANSYT Program can now be run on a 486 PC and similar advances in micro processors have given local controllers the "intelligence" that used to occupy large main frame computers, thus simplifying the need for expensive telecommunication networks.

**8.2** ATC systems improve road safety, they no longer require expensive "command centres", with a large public service staff and they normally have exceptionally high Benefit/Cost ratios that make them potentially attractive to international lending agencies and banks.

**8.3** Warrants for an ATC System vary from city to city and there are no hard and fast rules that can be followed, however, some basic guidelines would cover:

- the city centre, where there is a high density of signals
- the streets used by public transport vehicles
- one-way suburban roads signals are up to 600m apart
- the main corridors and on the side streets up to 300m from the corridor
- the access roads to the city from major highways
- isolated junctions (using DUET or similar) that are overloaded during peak hours.

**8.4** An analysis of existing traffic signals, with or without coordination, plus those sites where counts or other data suggest the installation of signals, using the above criteria will tend to show the areas or sub-areas that would probably benefit most from a modern traffic signal scheme, such as those indicated in figure 34.

**8.5** Obviously, if the city has a population of several million with a large and fast growing fleet of cars and buses, then some form of responsive control, such as SCOOT should be considered. In the city centre, important isolated junctions can also benefit from the application of an intelligent vehicle responsive system, such as MOVA (TRL. 1993.). Most cities in the developing world, however, will obtain the highest benefits from updating their traffic control system for a simpler model using prefixed timings.

**8.6** In this case, TRANSYT is a good tool for evaluating a proposal.

**8.7** Having arrived at the study area (or areas) a TRANSYT simulation for each area should be carried out, using real traffic data for each junction. If this data is not available, then new counts have to be made.

**8.8** If the number of junctions in the initial proposal leads to a cost that is unacceptable to the city authorities, then the difficult task of reducing the proposal has to be undertaken, eliminating (or transferring to a later stage) those junctions or sub-areas that show least benefits - providing that neither the safety nor the basic concept of the system is impaired.

**8.9** TRANSYT simulations of these new areas, scaled to meet budget requirements, will then provide

- the existing operating costs and travel delays (using existing flows and timings) for each peak period

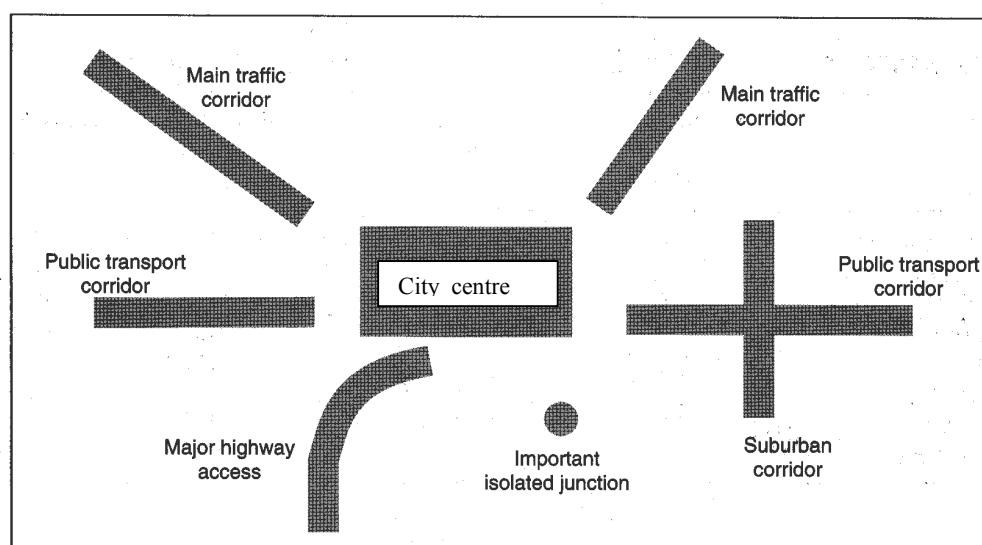

Figure 24 Definition of ATC system sub-areas

- optimized operating costs and delays (using the optimizing process), for each peak period
- existing operating costs and delays for the off peaks
- optimized operating costs and delays for the off peaks.

**8.10** This same process can be repeated for a three, five and ten year horizon, using the relevant traffic growth factors (based on recent traffic or vehicle growth data). The yearly time and operating benefits of the proposed system can then be estimated over the project's useful life.

**8.11** According to Table 6, a 20% reduction on the accident costs within the proposed area(s) could also be included.

**8.12** In developing cities it should be remembered that bus (public transport) normally plays a major role and so these travel benefits should be calculated, if possible, separately. The value of time savings is always a delicate point - especially as these are aggregated in small amounts for a very large number of people. However, it is standard practice to allocate a reasonable value to these for economic evaluation.

**8.13** On major public transport trunk routes, the extra fleet capacity gained during the peak hours may also be relevant and could be included as a real benefit if this means the postponement of additional fleet capacity during the project's lifespan.

**8.14** Table 8 below shows the costs of installing a new traffic signal layout to different parts of the world. A rough estimate of junction cost for a modern, simple ATC System would be around US\$20.000 - excluding the costs of data transmission and any detectors.

**8.15** DUET systems require the cooperation of the local telephone service - normally by contracting the lines, including their maintenance and installation costs. This requires a written proposal providing annual costs per junction.

**8.16** Software, engineering and system maintenance costs vary greatly from city to city according to the size and specifications of the proposed system. However, an additional 30-40% of the total would give a rough estimate.

**8.17** Considering the speed of advances in electronics and telecommunications a useful life of 10 years can be expected for ATC/UTC projects, allowing for a residual value of 20% of the total project cost after year 10.

**8.18** For two projects in Latin America, both nonresponsive using prefixed timings, the economic data for the systems can be summarized as:

**8.19** Project a), Cost = US\$ 5,794,000. Benefit/Cost Ratio = 2.41. Internal Rate of Return = 39.88

**8.20** Project b) Cost = US\$ 5,000,000. Annual time savings = US\$ 2,000,000. Annual fuel savings (excluding national and local taxes) = US\$ 3,709,548. Annual accident cost savings = US\$ 2,640,000

**8.21** In both cases it is clear that projects of this kind have an extremely high economic return. In fact, when a city proposes to upgrade its traffic signal system from isolated junctions with just one cycle time and plan to a simple ATC network it is no exaggeration to claim that the scheme will pay for itself in a question of months.

**TABLE 8: ESTIMATES OF TRAFFIC SIGNAL INSTALLATION COSTS PER JUNCTION**

city	pop. (106)	junctions with signals	cost/simple junction (US\$)	cost/complex junction (US\$)
São Paulo	12.0	4000	4.150	36.000
Santiago	4.5	980	14.300	28.600
Curitiba	1.6	350	12.000	18.000
Nairobi	1.5	27	18.000	26.500
Harare	1.0	152	8.000	16.000
Bombay	11.0	305	12.000	18.000
Istanbul	4.0	300	14.000	55.000
Islamabad	0.4	41	10.450	13.550

## 9. SPECIFICATIONS

**9.1** Most countries have developed their own national specifications for traffic signal materials, based either on local experience and production or on international standards used in the larger markets of North America, Japan, European Community, etc. Detailed specifications of equipment and services are beyond the scope of this report, however, some basic requirements can be resumed as follows

### TRAFFIC SIGNAL CONTROLLERS

**9.2** The increasing demand for better traffic control mechanisms and the advancements in technology have introduced the microprocessor-based traffic signal controller - now a fairly standard, cheap and reliable form of control.

**9.3** A major difference arising from the use of microprocessors is that the operating parameters such as timings are stored in memory rather than by switches or potentiometers. Changes in operation are accomplished by the use of hand-held terminals, although safety requirements are met by storing the basic site configuration data and control program on programmable read only memories (PROMS), alterable only by signal maintenance personnel. High reliability is also achieved by removing as many moving parts as possible and by using inbuilt self-monitoring and automatic fault reporting capabilities.

**9.4** Essential features of this type of controllers are:

- 'intelligence' and flexibility inherent to microprocessor systems offers the possibility of easy modification as requirements change.
- capability of operating in any of the following modes:

**9.5 Hurry Call.** This mode may be requested by the local detector or by switch input to allow priority to be given to a particular movement for the passage of emergency vehicles such as fire engines or rapid transit vehicles.

**9.6 Manual.** This mode will allow the controller to operate under emergency manual control.

**9.7 Local Coordinate Mode.** Multi-plan operation in this mode shall be possible in accordance with plans and timetables stored in the memory.

**9.8 Local Isolated Vehicle Actuated Mode.** The controller in this mode may operate with a mixture of fixed time, demand dependent or vehicle actuated phases.

**9.9 Amber flashing on all approaches.**

- capability of linking to a pedestrian controller for coordinated control.

- capability of incorporating pedestrian push buttons, pedestrian wait indicators and pedestrian audible signals.

**9.10** Most controllers offer a minimum setup of 4 stages and/or 8 phases, allowing for expansion to 8 stages and/or 16 phases, without the need to change the cabinet or internal architecture of the equipment.

### GENERAL ROAD TRAFFIC SIGNALS

**9.11 Vehicular** signals should contain three optical systems arranged vertically each having a nominal diameter of 200mm.

**9.12** Pedestrian signals should contain two optical systems arranged vertically and shall normally each have a nominal diameter of 300mm - an alternative size of 200mm nominal diameter may also be used where necessary.

**9.13** Where an optical system incorporating a green arrow is used, it should normally have a nominal diameter of 300mm - an alternative size of 200mm nominal diameter may also be used if necessary.

**9.14** Signal heads should have adequate mechanical strength and durability to withstand the conditions of installation and normal use operations. It should be dust proof and weatherproof against corrosion and action of direct sunlight without significant deterioration. The signal head assembly together with the attachment of a backing board should be capable of withstanding wind velocities up to 160 Km/hour in any direction and temperatures over a range of -25°C to 70°C.

**9.15** Normally, the signal heads will be made from polycarbonate or cast aluminium.

**9.16** High intensity lamps should be used for enhancing visibility.

### INDUCTIVE LOOP DETECTORS

**9.17** The basic system consists of a loop of wire (typically 2 or 3 turns) buried approximately 5mm below the road surface. The ends of the loop are returned to the vehicle detector, usually housed some distance away in the controller cabinet. A small electric current is passed through the loop and this causes an electric field to be built up.

**9.18** A change in the inductance of the loop occurs when a vehicle is positioned directly over it - or is passing over the loop. The change in inductance is sensed by the unit and a signal change indicates the presence of a vehicle.

**9.19** Provided that loop detectors are properly installed, tested and maintained, they will work reliably and offer efficient and accurate detection as well as providing congestion, counting and vehicle classification information.

## ASSOCIATED ELECTRICAL WORKS

**9.20** These works include

Laying of aspect cables, linking cables (or telecommunications cables in an ATC area).

necessary cable jointing work, signal wiring and connection work.

## TRAFFIC SIGNAL CONTROLLER CIVIL WORKS

**9.21** Again, the specifications of civil works vary from country to country, however, it is recommended that all cabling should be underground using ducts as shown in figure 25. Inspection boxes, normally 60cm on each side should be built every 50m (maximum). In developing cities the pavement is often dug up for new services, so to avoid the severance of cables, the ducts should be protected by a plastic strip in bright colours (normally yellow with black identification).

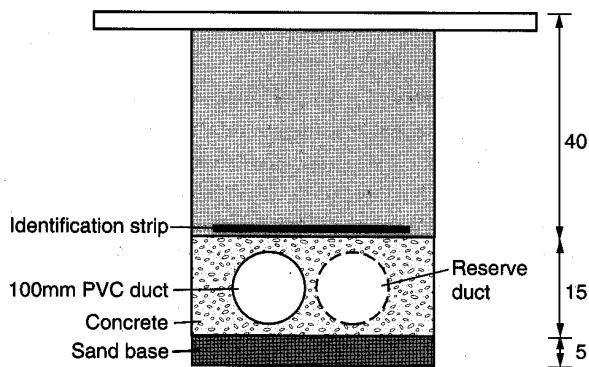

**Figure 25** Cross section of cable duct

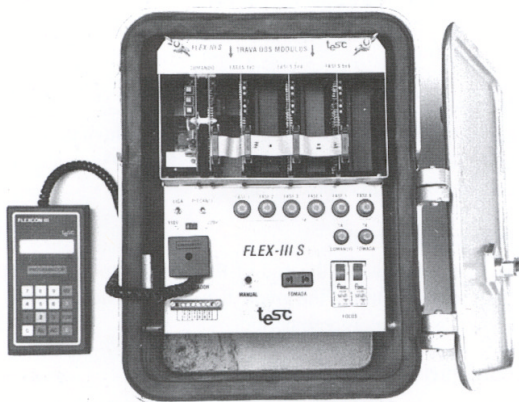

**Plate 3.** Microprocessor controller suitable for pole installation at simple junctions

## 10. GLOSSARY

A short glossary of terms used in this volume in alphabetical order is given below:

### All red period

Period when red signals are shown to all approaches simultaneously, usually of short duration to allow vehicles to clear the intersection.

### Audible signals

Signals in the form of pulsed tones provided for the benefit of visually handicapped pedestrians.

### Area Traffic Control (ATC)

Also called Urban Traffic Control (UTC), this is the centralized control of traffic signals on an area wide basis by means of computer.

### Backing board

The Background board is usually coloured black with a white border which is placed behind signal lanterns to make them more visible against a bright sky or other street or shop lights.

### Cycle time

A cycle is a complete series of stages during which all traffic movements are served in turn. The cycle time is the sum of the stage times.

### Degree of saturation

The degree of saturation at an approach is the ratio of the design flow to the actual capacity of a particular approach, weighted by the amount of green the approach receives in a cycle.

### Delay

Traffic Delay is the lost time by vehicles due to traffic 'friction', congestion or control devices.

### Demand

A request for right of way for traffic on a phase which has no right of way when the request is made. The demands normally being stored in the controller and served in a prearranged order.

### Demand - dependent stage/phase

A demand-dependent stage or phase is one which appears only on demand from a vehicle detector or pedestrian push-button. i.e. it is skippable.

### Detector

A device to detect the presence or passage of a vehicle in the roadway.

### Early cutoff overlap

Condition in which one or more traffic streams are permitted to move after the stoppage of one or more other traffic streams, which during the preceding stage had been permitted to move with them.

### Effective green period

The period in the green and amber periods throughout which flow could take place at saturation flow levels.

### Extension

A request for the continuation of the green signal to a predetermined maximum, made by a vehicle which, when the request is made, has the right of way.

### Fixed-time traffic signals

Traffic signalling equipment in which the stages and their duration in each cycle are preset to suit predictable traffic conditions.

### Flow factor

The flow factor or 'y' value of an approach is the ratio of the design flow to the saturation flow of the particular approach.

### Green filter arrow

An additional green arrow mounted by the side of the three light display to indicate early movement in the direction of the arrow and is terminated by a full green light signal. It is normally used for early discharge of left turners ahead of other movements at the same approach.

### Green split

The ratio of green time allocated to each of the conflicting phases in a signal sequence.

### Grid lock

The state in which downstream traffic completely blocks the junction, which then forms queues that blocks other junctions, and so on until the whole area is blocked with stopped traffic.

### Indicative green arrow

An additional green arrow mounted on the right of the three light display of the secondary signal only, to indicate the early cutoff of an opposing flow.

### Intergreen period

The period between the end of the green display on one stage and the start of the green display on the next stage is known as the intergreen period.

### Late start overlap

Condition in which one or more traffic streams are permitted to move before the start of one or more of the traffic streams which, during the subsequent stage are permitted to all run together.

**Lost time**

Lost time in the green and amber periods is the wastage time during which no flow takes place. Total lost time per cycle is the sum of these lost times for the critical phases plus other lost times due to red-amber periods, all red periods and pedestrian green and flashing green times.

**Maximum green running period**

The maximum time that a green signal can run after a demand has been made by traffic on another phase.

**Minimum cycle time**

The minimum cycle time which is just sufficient to pass the traffic.

**Minimum green running period**

The duration of the green signal following the extinction of a red/amber signal during which no change of signal lights can occur.

**Offset**

The time difference or interval in seconds between the start of the green indication at one intersection as related to the start of the green interval at another intersection from a synchronized system time base.

**Optimum cycle time**

The theoretical cycle time for attaining minimum vehicle delay.

**Passenger car units**

Passenger car units for a given type of vehicle are expressed in terms of the number of moving passenger cars it is equivalent to, based on headway and delay characteristics.

**PCU factor**

An average pcu value derived for the convenience of signal calculation to convert unclassified (by type) vehicle counts from vehicles per hour units to pcu per hour units.

**Phase**

The sequence of conditions applied to one or more streams of traffic which during the cycle, receive identical signal light conditions. Two or more phases may overlap in time. A series of phases is usually arranged in a predetermined order but some phases can be omitted if required.

**Practical cycle time**

The cycle time at which the traffic signal installation will be loaded to 90 per cent of its capacity.

**Reserve capacity**

A measure of the spare capacity of a signal controlled junction, expressed in terms of the percentage of the current total flow factor value (Y) which will be available for further increase of traffic flows.

**Red-running**

The act of disobeying, consciously or not, the red signal requiring vehicles on a determined approach to stop and remain stationary.

**Right of way**

The condition which applies when a green signal is displayed to traffic at the approach thereby permitting that traffic to proceed.

**Saturation flow**

The maximum flow which could be obtained if 100 percent green time was awarded to a particular approach.

**Semi-vehicle-actuated signals**

Modified vehicle-actuated signals whereby detectors are installed on the side roads only. Some semi-vehicle-actuated signals also operate one or more demand-dependent stages within a fixed cycle time.

**Stage**

A condition of the signal lights which permits a particular movement of traffic. Stages usually, but not always contain a green period. They are arranged to follow each other in a predetermined order but stages can be skipped, if not demanded, to reduce delay.

**Spillback**

Queue from a downstream junction which affects the traffic flow at the junction being examined.

**Traffic signals**

A system of different coloured lights, including arrow-shaped lights, for controlling conflicting streams of traffic and pedestrians.

**Traffic signal controller**

The electronic control equipment which activates the signal phases at an intersection.

**Vehicle-actuated (V.A.) signals**

Traffic signalling equipment in which the duration of the green time and cycle length varies in relation to the traffic flow on its approaches.

**Vehicle extension period**

A vehicle extension period is the additional duration of the green signal which is secured by the actuation of a detector.

**Transyt**

An abbreviation of 'Traffic Network Study Tool', a program developed by the Transport and Road Research Laboratory for optimizing signal timings.

## 11. REFERENCES

- Burrow, I.J. OSCADY: A Computer Program to Model Capacities, Queues and Delays at Isolated Junctions. *TRRL Research Report 105*. Transport and Research Laboratory. 1987.
- Cannell, A. E. R. and Kaestner, C. Some Aspects of Area Traffic Control in Semi-Developed Countries. *Traffic Engineering and Control*. 1983.
- Companhia de Engenharia de Transito -CET. Semaforos, Aspectos de Seguranca. Sao Paulo. 1990.
- Department of Transport. Junction Layout for Control by Traffic Signals. *Highway, Safety and Traffic Advice Note TA 18/81*. Department of Transport. 1992.
- Fouracre, P. R. and Gardner, G. Traffic Signals in Developing Cities, *Overseas Unit Working Paper*. Transport and Road Research Laboratory. 1990.
- Gardner, G, Fouracre, P.R. and Jacobs, G.D. Traffic Management. *Overseas Unit Information Note*. Transport and Road research Laboratory. 1990.
- Hunt, P.B, Robertson, D.I, Bretherton, R.D. and Winton, R.I. SCOOT: A Traffic Responsive Method of Coordinating Signals. *TRRL Report 1014*. Transport and Road Research Laboratory. 1981.
- Hurdle, V.F. Signalized Intersection Delay Models- A Primer for the Uninitiated. *Transportation Research Record 971*. Transportation Research Board. Washington, DC. 1984.
- Institution of Highways and Transportation/ Department of Transport. Roads and Traffic in Urban Areas. HMSO, London. 1987.
- Jourdain, S. Urban Intersection Control. The Book Guild Ltd. Lewes, Sussex. 1992.
- Robertson, D.I. and Hunt, P.B. A Method of Estimating the Benefits of Co-ordinating Signals by TRANSYT and SCOOT. *Traffic Engineering and Control* 1982.
- Robertson, D. I. Transyt: A Traffic Network Study Tool. *RRL Report 253*. Road Research Laboratory, Crowthorne. 1969.
- Robertson, D I, A Method of Estimating the Benefits of Coordinating Signals by TRANSYT and SCOOT. *Traffic Engineering and Control*. London. 1982.
- TRL. Urban Road Traffic Surveys. *Overseas Road Note 11*. Overseas Centre, Transport Research Laboratory. 1993.
- TRL. Design Guidelines for Busway Transit. *Overseas Road Note 12*. Overseas Centre, Transport Research Laboratory. 1993.
- Vincent, R.A. and Pierce, J.C. MOVA: Traffic Responsive, Self-Optimising Signal Control for Isolated Intersections. *TRRL Research Report 170*. Transport and Road Research Laboratory. 1988.
- Vincent, R.A, Mitche, A.I. and Robertson, D.I. User Guide to TRANSYT Version 8. *TRRL Report LR888*. Transport and Road Research Laboratory. 1980.
- Walker, J.S, Jacobs, G.D. Gardner, G. and Kunchit Phiu-Nual. The Development of Traffic Management Policies in Bangkok. *Paper presented to CODATU Conference*. Jakarta. 1988.
- Webster and Cobbe. Traffic Signals. *Road Research Technical Paper No. 56*. H.M.S.O. London, 1966.
- Willumsen, L.G. and Coeymans, J.E. Research into the Value of Area Traffic Control Techniques in a Developing Contry. *TRRL Contractor Report 99*. Transport and Road Research Laboratory. 1988.

ISSN 0951-8987

OS-E

**The use of traffic signals in developing cities**

**ORN13**