

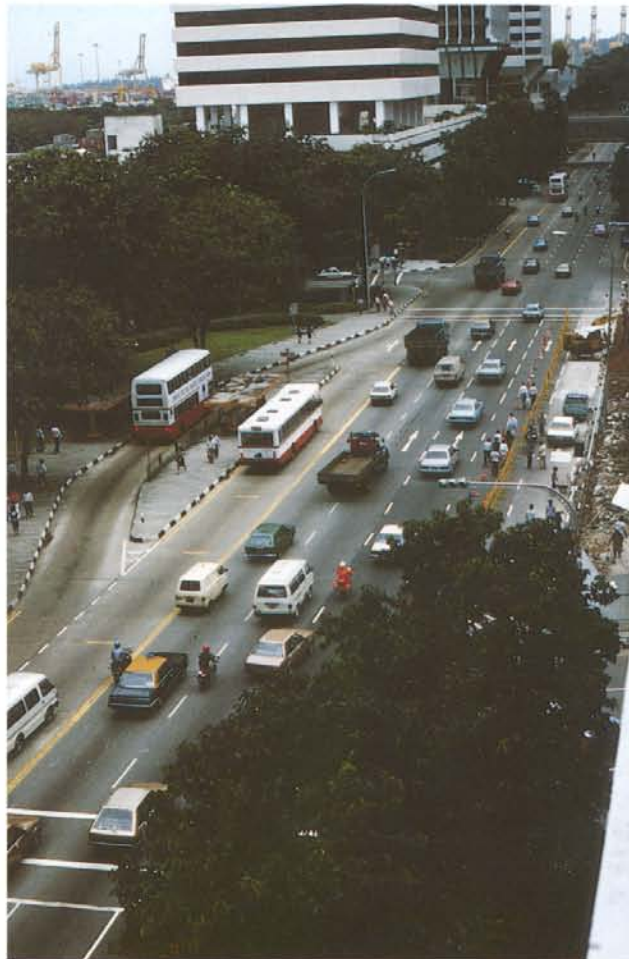

OVERSEAS ROAD NOTE 12



Design Guidelines for Busway Transit



Overseas Centre
Transport Research Laboratory, Crowthorne, Berkshire, United Kingdom



Old Wokingham Road
Crowthorne
Berkshire
RG11 6AU

Overseas Development Administration
94 Victoria Street
London
SW1E 5JL

OVERSEAS ROAD NOTE 12

DESIGN GUIDELINES FOR BUSWAY TRANSIT

Main Subject area: Urbanisation/Transport, energy efficiency

Theme: Urban Transport

Project title: Design guidelines for busway transit

Project reference: ODA 85596

This document is an output from an ODA-funded research project, carried out for the benefit of developing countries.

Crown copyright 1993. The views expressed in this report are not necessarily those of the Overseas Development Administration or the Department of Transport.

Overseas Centre, TRL, 1993
ISSN 0951-8987

ACKNOWLEDGEMENTS

This Note was prepared by Dr. P R Cornwell and J A Cracknell of Traffic and Transport Consultants Ltd., and G Gardner of the Overseas Resource Centre, Transport Research Laboratory (TRL). It has been edited for the ORN series by Dr. J C Rutter and P R Fouracre of the Overseas Resource Centre, TRL.

First published 1993

OVERSEAS ROAD NOTES

Overseas Road Notes are prepared principally for road and transport authorities in countries receiving technical assistance from the British Government. A limited number of copies is available to other organisations and to individuals with an interest in roads overseas, and may be obtained from:

Transport Research Laboratory
Crowthorne, Berkshire, RG11 6AU
United Kingdom

© Crown Copyright 1993

Limited extracts from the text may be reproduced provided the source is acknowledged. For more extensive reproduction, please write to

Programme Director,
Overseas Resource Centre, Transport
Research Laboratory.

CONTENTS

	Page		Page
1. Introduction	1	4. Bus stops	27
Purpose and scope of this note	1	Bus stop design	27
Bus priority measures	1	Capacity	27
Spot priorities	1	Design considerations	27
Bus lanes	2	Layouts	27
Busways	2	Bus stop spacing	34
Busway transit	2	Bus stop location	34
Special operational measures	2	5. Evaluation	34
Busway transit performance	5	Definition of options	34
The case for busway transit	5	Busway transit costs	34
2. Planning considerations	7	Capital costs	34
Planning context	7	Operating costs	35
Allocating roadspace	8	The impact of busway transit	35
Feasibility and warrants	8	The users	35
Capacity concepts	9	Transport operators	36
System planning parameters	10	Non-users	36
Regulatory framework	11	Urban development	36
Organisation and management	11	Other impacts	37
3. Track design	13	Economic evaluation	37
Track options	13	6. References and bibliography	37
Means of separation	13		
Typical cross-sections	22		
Horizontal and vertical alignment	22		
Intersections	23		
Layouts	23		
Signal control	23		
Collector/distributor systems	25		
Guidance systems	25		
Other aspects	26		

DESIGN GUIDELINES FOR BUSWAY TRANSIT

1. INTRODUCTION

PURPOSE AND SCOPE OF THIS NOTE

The purpose of these design guidelines is to assemble current ideas on busway transit and to offer transport planners and designers a source of practical information on their use and implementation. Thus this Note is primarily directed at practitioners rather than policy makers. The focus of the content is on busway transit rather than general bus priority measures. The note complements a TRL report on busway transit performance (Gardner et al, 1991) and contains examples of current practice, derived from published information and from observation of operational schemes around the world.

- 1.2 Busway transit is a true urban mass transit option, which bears comparison with the fixed rail systems of Light Rapid Transit (LRT) and metros. Busway transit, the physical segregation of bus and other traffic, offers the possibility of introducing a mass transit system at relatively low cost. It is important to distinguish busway transit from other bus priority measures which are more limited in their scope. In order to make this distinction some initial reference is made to other bus priority measures. The remainder of the Note then examines the components that make up busway transit: planning considerations, track requirements and bus stop

design. The Note concludes with an outline to the appraisal of busway transit.

BUS PRIORITY MEASURES

- 1.3 Buses are one of the most space-efficient and cost-effective means of transporting large numbers of people. Where traffic flows are well below the capacity of the road network, buses can share roadspace with other traffic and, in general, there is little need for special priorities for buses. However, where road traffic volumes are high in relation to road capacity, buses suffer from the congestion and delays caused by other road users, and priorities are needed to release buses from traffic congestion. There are three main ways in which this can be achieved, which are: spot priorities, bus lanes and busways.

Spot priorities

- 1.4 Most bus delays occur at bus stops and junctions, rather than along running sections. Junction-related delays can be dealt with by spot priorities, examples of which are turn-ban exemptions and bus gates. Turn-ban exemptions permit buses to turn out of a particular road, where this movement is banned to other traffic. Bus gates permit buses to turn into a particular road, where this movement is banned to other traffic (Plate 1). However, while



Plate 1 A bus gate providing buses with unhindered access to main road: Hong Kong

spot priorities are a useful traffic management measure, they cannot by themselves improve bus performance over whole routes

Bus lanes

- 1.5 Bus lanes are road lanes reserved for the use of buses only. Short bus lane sections at junction approaches can allow buses to "queue-jump" and bus-activated traffic signal pre-emption can reduce delays. Bus lanes can also be used to give buses priority over long sections, provided they are respected by all road users. There are two main types of bus lane: with-flow and contraflow (Plates 2 and 3 respectively). With-flow bus lanes are employed extensively, but in environments where road user discipline is poor, with-flow lanes tend to be violated by other vehicles and are relatively ineffective. In contrast, contraflow bus lanes tend to be self-enforcing, since buses travel in the opposite direction to other vehicles. However, there are some indications that pedestrian/bus accident rates may be higher along contraflow than along with-flow bus lanes.
- 1.6 A traffic scheme may include both with-flow and contraflow lanes, as well as spot priorities. Although one lane is usually provided in each direction for buses, two lanes may be provided where bus volumes are high, at busy bus stops (to allow buses to overtake one another) or on long uphill sections (e.g. as in Belo Horizonte, Brazil).

Busways

- 1.7 The traffic violations experienced by with-flow bus lanes can be overcome by physically segregating buses from other traffic by means of studs, kerbs or fences. In this report, the distinction is made between a bus lane and a busway as follows:
 - a Bus Lane is essentially a "**paint-and-sign**" scheme where buses are separated from other traffic by road markings or separators, which

dissuade but physically permit crossing by both buses and general traffic.

- a Busway involves **construction** where schemes may be partially physically segregated from other traffic, for example in the vicinity of bus stops (e.g. by means of island stops) or may be fully segregated from other traffic by kerbs or fences.

BUSWAY TRANSIT

Special operational measures

- 1.8 A basic busway, comprising one lane for buses in each direction is essentially a traffic engineering measure. However, performance of this basic busway can be enhanced substantially by adopting various "**special operational measures**" in order to form a "busway transit system" (Table 1).
- 1.9 Where passenger demands are high, the provision of facilities to permit buses to overtake one another at bus stops can increase throughput and commercial speed considerably. This is because bus congestion is reduced and buses are no longer "trapped" behind one another in a single lane (as occurs with trams or light rail vehicles). Plate 4 shows the Avenida 9 de Julho busway in Sao Paulo, which has bus overtaking facilities at all but two stops over an 8 km length and achieves high performance (Gardner et al, 1991).
- 1.10 Trunk-and-feeder operations also offer good performance. In this system, feeder buses collect passengers and bring them to a transfer terminal, where they transfer to line-haul buses; some systems allow transfer without payment of an additional fare.
- 1.11 Early work in Brazil led to the development of a high-capacity bus convoy scheme (COMONOR), in which buses were assembled at the beginning of a section in the order in which they would stop along the route (to form the on-street 'train'). Although not

Table 1: Special Operational Measures

Busway Transit = Busway Infrastructure + Special Operational Measures

Special Operational Measures Include:

- ❖ bus overtaking facilities at stops;
- ❖ trunk-and-feeder operations;
- ❖ bus ordering (placing buses in the correct order at the beginning of the section);
- ❖ high-capacity buses (e.g. articulated or double-deck)
- ❖ off-board ticketing;
- ❖ traffic signal techniques to give buses priority at intersections;
- ❖ bus dwell time management (to eliminate excessive delays at very busy bus stops); and guidance systems (e.g. O-Bahn).



Plate 2 With-flow bus lane: Bangkok

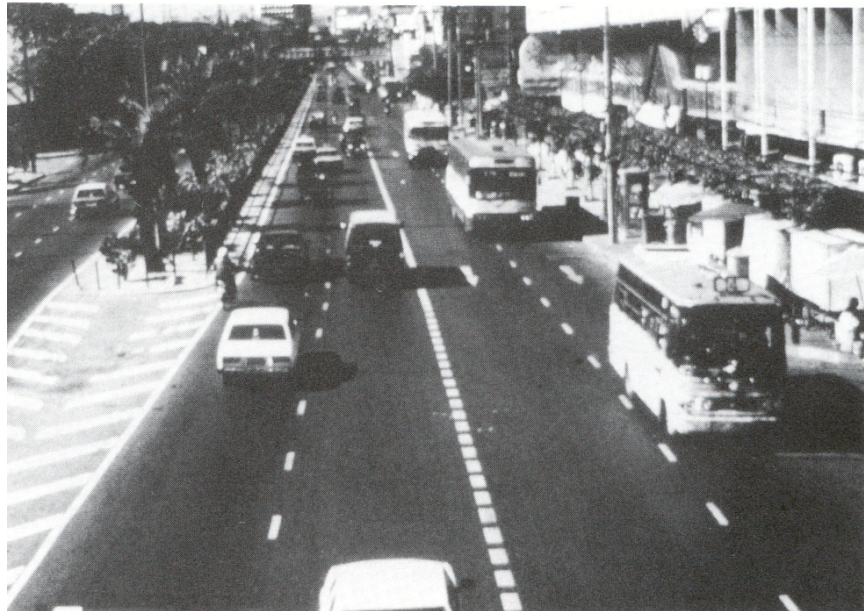

Plate 3 Contra-flow dual bus lane: Bangkok

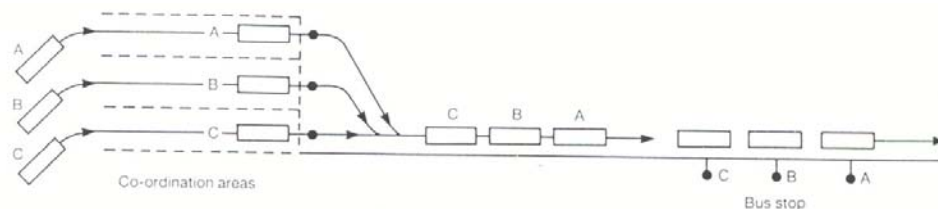

**Plate 4 Busway transit stop, with overtaking facility:
Sao Paulo**

joined together, the group of buses started and stopped broadly in unison. COMONOR was initially successful but was found to be too difficult to sustain on a day-to-day basis. It evolved in Porto Alegre, for example, into "bus ordering" in which buses are allocated to one of three groups (A-B-C). The buses arrive in random order at the beginning of a section and are marshalled into the preferred sequence, though not into strict convoys (Figure 1). This method operates effectively and can improve commercial speeds at high levels of passenger demand.

- 1.12 Line-haul capacity can be enhanced by the use of high-capacity buses, whether articulated, double-deck or with the use of bus + trailer. However, passenger transfer capacity at bus stops is often the constraint on system performance, and door configurations and ticketing arrangements are often more important than bus capacity alone.
- 1.13 Various traffic signal techniques are available to give priorities to buses. However, where bus flows are high, there is a "constant" call for green time by buses and selective-detection of buses may not be appropriate.

Figure 1: COMONOR - Bus Convoy Operations



(from Roads and Transport in Urban Areas, IHT/HMSO 1987)

- 1.14 Bus delays at bus stops can be minimised by collecting fares and issuing tickets prior to passenger boarding (i.e. off-board) - see Plate 5. At bus stops where passenger volumes are very high, excessive bus dwell times can occur when many passengers try to board incoming buses, and block the doorways such that the doors cannot be shut. Figure 2 illustrates how bus dwell times tend to increase sharply once the capacity of the bus is reached and crush-loading sets in. This problem can be minimised by assigning staff to control boarding.
- 1.15 Finally, the provision of a guidance system may, under some circumstances, enhance performance. This aspect is dealt with in Section 3.

Busway transit performance

- 1.16 Surveys were carried out by TRL in 1989-90 to measure passenger throughputs and bus commercial speeds for selected busway transit schemes in Brazil, Cote d'Ivoire and Turkey (Gardner et al, 1991). From these measurements, the practical capacity of busway transit was determined for various design characteristics. These estimates are summarized in Table 2. The conclusion from this survey of performance was that well designed and efficiently run busway transit systems can achieve consistent flows of 25,000 passengers per hour per direction, and at speeds of up to 25 kmph.

The case for busway transit

- 1.17 The main advantages of busway systems are (Cornwell and Cracknell, 1990):
- Flexibility. Since buses can join and leave a busway along its length, routes serving many parts of a city can use a busway over part or all of its length. Passengers from a wide catchment area can therefore benefit from improved services, without having to change vehicles (as required with a fixed-track system).
 - Affordability. A basic at-grade busway along an existing right-of-way is likely to cost of the order of US\$1 million/km (end-1989 values), depending upon the need for utility relocation and other local factors.
 - Self-enforcement. Because a busway physically segregates buses from general traffic, busways are virtually self-enforcing and do not require a permanent police presence to be effective.
 - Scope for incremental development. Sections of even a few hundred metres of busway can be useful (whereas rail transit needs a depot and a significant route length before it can attract passengers). Busway transit can be enhanced step-by-step (e.g. by adding grade separation at critical intersections; introducing off-bus ticketing) as and when finance permits.

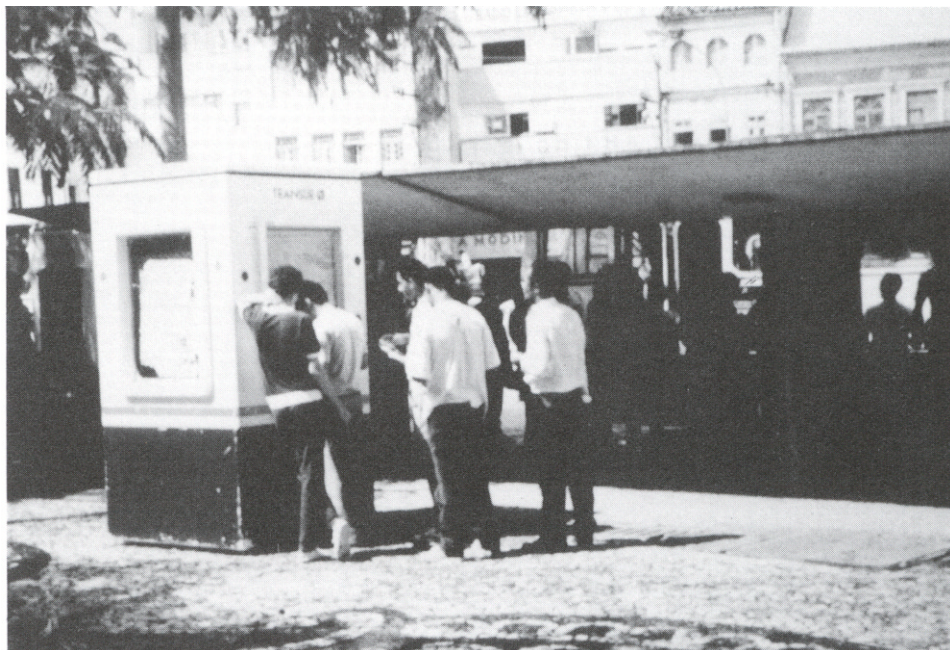
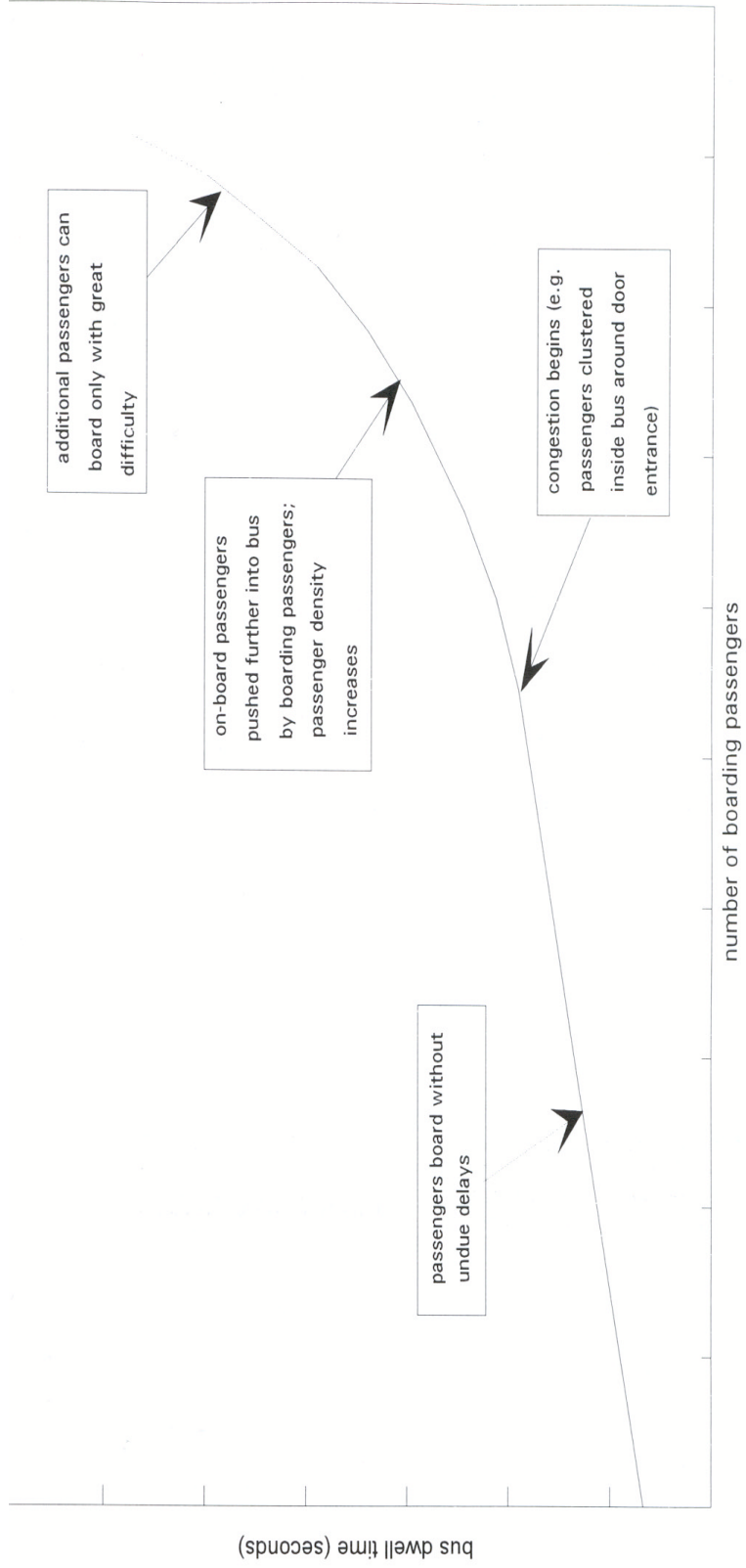

Plate 5 Off-board ticket sales; Salvador

Figure 2 Bus Dwell Times and number of Boarding Passengers



Note: The precise shape of the curve depends upon bus capacity, number of on-board passengers when the bus enters the stop, and the number of doors.

Table 2: Measured and Estimated Busway Performance (predominantly boarding direction)

Description	Example	Measured Peak hour Flow Range pass/hour	Estimated Practical Capacity* pass/hour
Basic Busway - No Options	Ankara Istanbul Abidjan**	} 7300 - 19500	5800 -18100
Trunk and Feeder Bus Ordering	Curitiba Farrapos	9900	13900 - 24100
Overtaking + Express Services	Assis Brasil** Belo Horizonte Sao Paulo	} 17500 - 18300 } 15800 - 20300	8200 -14700 14900 - 27900
Optimum Combination of High Capacity Options	None	NIA	30600

* Capacity estimated for different combinations of passenger demand and bus stop layout, using procedure, assumptions and capacity criteria given in Appendix E, RR329 (Gardner et al, 1991)

** Flows measured when systems were operating above capacity.

- Measured flows may not represent maxima because of limited demand

- Foreign exchange. Since busways can usually be constructed with local labour and materials and, in many countries, operated with locally produced vehicles, the foreign exchange requirement is minimised.
 - Existing experience. Busways enhance the use of buses, the predominant transport mode in most cities, and can draw upon the wealth of experience and knowledge of bus operations already available.
- 1.18 One of the main disadvantages of busway transit, however, is that their implementation requires the active cooperation of the highway authority, the licensing authorities, the police and bus operators; such cooperation can be difficult to achieve.

2. PLANNING CONSIDERATIONS

PLANNING CONTEXT

- 2.1 Given the performance figures noted in Section 1, busway transit is likely to be suitable in a variety of locations, typical examples being:
- in the main corridors of medium-sized cities, where public transport travel demands are up to about 20-25,000 passengers/hour/direction (p/h/d).
 - in the secondary corridors of large cities, to complement rail mass transit.
 - in outer city suburbs, to structure newly urbanizing areas.

- 2.2 More than forty busways exist worldwide, though only a handful of cities have developed them in a systematic and comprehensive manner as the framework of the city's mass transit network. The best example of the widescale use of, and dependence on busway transit is in Curitiba. There, in a city of just over one million population, busways form the backbone of five 'structural axes' radiating from the city centre and along which city growth is focused.
- 2.3 In planning a system, it is important to distinguish between a basic busway as a traffic management measure, to meet short-term traffic objectives, and a bus-based mass transit system, including special operational measures, to meet medium-long term objectives. Although the physical infrastructure in each case might be similar, the operational and organisational arrangements for busway transit are an important component of the system and require careful planning.

ALLOCATING ROADSPACE

- 2.3 Where a busway is to be inserted into an existing right-of-way, difficult issues arise over the allocation of roadspace between the conflicting demands of different road users. In many cities, there is insufficient roadspace to meet the unconstrained demands of all road users and it is necessary to have a demand management policy to guide the allocation of roadspace. Where the policy is one of "laissez faire", buses are likely to suffer severely from the congestion caused by other road users. However, where there is a positive policy to restrain the use of private cars and to promote the use of public transport, busways give physical expression to this policy objective.
- 2.4 Where passenger demands are high, there is no doubt that the number of passengers that can be transported along a bus lane or busway is substantially more than can be transported by private cars along the same lane. Nevertheless, if roadspace is allocated to buses, the roadspace must be seen to be used reasonably effectively. Where bus flows are relatively low, the bus track is vacant for the majority of the time and this can give rise to political pressures from the motoring lobby to reallocate the space to cars. One possibility is to permit the use of the busway by other specified vehicles (e.g. high occupancy vehicles).
- 2.5 Many bus lanes operate on a time-sharing basis (i.e. they are only restricted to bus use at certain times of day). However, this is a sophisticated operation which requires a high degree of road user discipline, unless bus flows are very high and buses effectively "occupy" the bus lane. Time-sharing is unlikely to be effective in many developing cities.

FEASIBILITY AND WARRANTS

- 2.6 Figure 3 illustrates the trade-off between traffic flow (degree of saturation) and bus flow; the chart indicates that this trade-off can be generalised into four basic scenarios. Case 1 is where passenger demand is modest and the road has spare capacity - bus priorities would not be needed in this case. In Case 2, although the road may be nearing saturation, bus priorities would be unlikely to be acceptable because of the relatively low volume of passengers and buses. Case 3 is where there are sufficient buses to make priorities worthwhile and acceptable, without significant disbenefits to other traffic (since the road has spare capacity) However, most important is Case 4: this is where bus priority is most needed but, because the road is already running at or near its capacity, the allocation of roadspace to buses would disbenefit other road users (unless additional capacity was provided). In this latter case strong political will is needed to implement bus priorities.
- 2.7 In cases where existing roadspace is limited, the allocation of existing scarce roadspace to buses may be justified because:
- a bus lane or busway can carry up to about 20,000 p/h/d, whereas a lane used by cars only is unlikely to carry more than 2-3,000 p/h/d at normal occupancy levels.
 - it may be easier to divert cars rather than buses to alternative routes
 - it may be more cost-beneficial to allocate existing roadspace to buses and to construct additional roadspace to be used by all vehicle types, rather than to construct the infrastructure required for a high-capacity rail mass transit system.
- Some of the most successful bus-related schemes have been where bus priorities were introduced in association with improvements to conditions for general traffic (e.g. Abidjan).
- 2.8 In some cities, decisions on roadspace allocation are taken on a purely political basis. In others, it is on the basis of the numbers of passengers which can be carried along a lane by buses or by private motor vehicles; elsewhere the decision might be made on economic grounds, taking into account time values and vehicle operating costs. Because of the wide variety of traffic and physical circumstances, a detailed assessment is generally needed for each scheme. Bus lanes can usually be justified where the minimum bus traffic is 20-40 per hour; most busway transit schemes will have flows in excess of 100 buses per hour.

Figure 3: Feasibility of Busway Along Existing Road

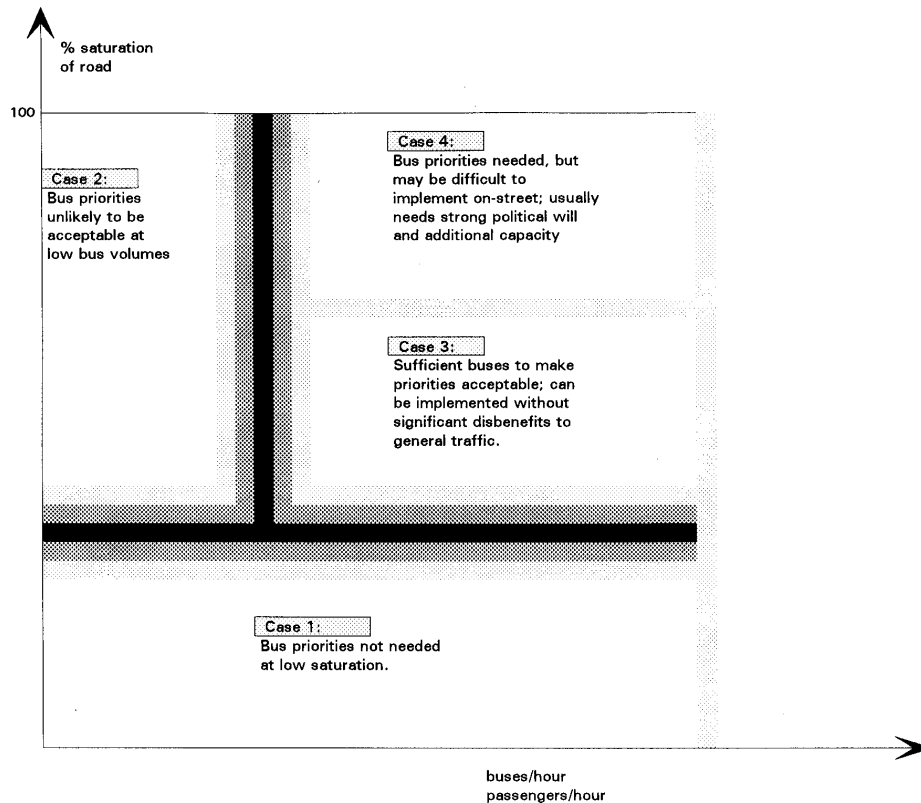

CAPACITY CONCEPTS

2.9 The technical literature contains many ambiguous references to the "capacity" of alternative transit systems (metro, light rail, bus etc.). Such statistics usually refer explicitly or implicitly to "line-haul capacity" However, it is also important to consider "passenger transfer capacity" (i.e. the maximum number of passengers who can board and/or alight at a stop/station during a given time period) since bus stop/station capacity is often the limiting factor in a transit system. Maximum line-haul throughput decreases as passenger transfer demands increase (i.e. line-haul capacity is a variable and it is not possible to quote a single "capacity" figure for a bus system without reference to passenger transfer demands and bus stop capacities) - see Figure 4.

2.10 It is even difficult to apply the traditional concept of line-haul capacity to bus systems. This is because the number of "available passenger places" on buses passing along a bus track does not correspond to the maximum passenger throughput

achievable. Without a trunk-and-feeder system, passengers will only board buses serving selected routes In practice it is impossible to fill every bus to capacity because of the imbalance between the number of empty spaces on a bus and the number of passengers boarding at each stop In some cases, a bus leaving a bus stop will have empty passenger places while in others, the bus may be full and leave some passengers waiting at the stop. This variation in loading from one bus to another imposes practical limits on average load factors (number of passengers/available passenger places) - the available evidence suggests that without special operational measures, it is difficult to achieve an average load factor in excess of 70-80% without severe overcrowding on many buses. Where load factors of the order of 100% have been observed (e.g. Sao Paulo), around 50-60% of buses were crush loaded (Figure 5).

2.11 Furthermore, since boarding and alighting times are substantially different, maximum line-haul passenger throughput is higher in the predominantly alighting direction than in the predominantly

Figure 4: Relationship Between Line-haul Throughput and Passenger Transfer Demand

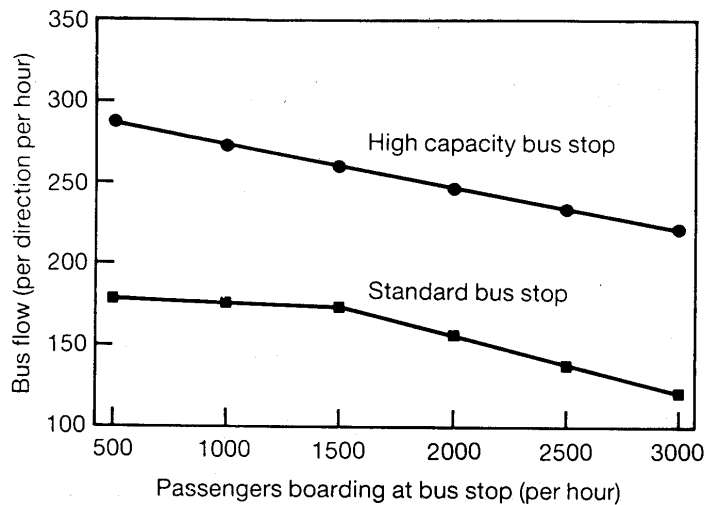

*Flows based upon estimation procedure as detailed in Gardner et al (1991)
Standard stop 3-bay on-line, High capacity stop 4-bay with overtaking*

boarding direction, for a given passenger transfer demand. For planning and design purposes, it will generally be critical to examine the predominantly boarding direction.

- 2.12 Unless bus entry to the busway is controlled, bus arrivals will be irregular and may lead to substantial peaking. TRL surveys of existing busways suggest that the peak 5-minute flow can be between 1.3 and 3.0 times the hourly rate.

SYSTEM PLANNING PARAMETERS

- 2.13 Figure 6 lists the main factors which influence the capacity of a bus lane or busway. The most important is probably the degree of segregation between buses and other traffic. The other critical components of a busway transit system which may constrain capacity include the running section (link), bus stops, junctions or the collector/distribution system.
- 2.14 In general, running sections are unlikely to be a bottleneck. Average bus headways of 4.5 seconds have been measured for bus platoons travelling along busways in Abidjan and Porto Alegre, corresponding to 800 buses/hour. If buses could be fed onto and off a busway at this rate, the line-haul "capacity" without bus stops would be of the order

of 80,000 or more p/h/d. But of course, stops are usually necessary and have a capacity substantially below this figure.

- 2.15 In many cases, the capacity constraint on a system will be a single bus stop. The interactions between passengers, bus and driver characteristics, and bus stop layout are complex. Again, "capacity" is variable and dependent upon passenger behaviour, arrival time patterns and many other factors. Stop/ station spacing also influences performance and Figure 7 illustrates the effect of bus stop spacing on bus commercial speed under typical operating conditions.
- 2.16 Junctions influence the flow of buses along at-grade busways and consequently affect both capacity and speed of bus operation. Traffic signal-controlled junctions (including pedestrian crossings) reduce the amount of green time available to the busway and impose delays to some buses. These delays reduce bus and passenger throughput, and average commercial speed. In some cases, a particularly busy junction may be the busway bottleneck - this is the case on Farrapos, Porto Alegre, where the junction adjacent to the central area "controls" the flow of buses off the busway and into the city centre during the morning peak. In most cases, however, junction capacity will be greater than that of the most critical bus stop.

1 It may be argued that the apparent advantage of rail transit over conventional bus systems is largely due to differences in the degree of segregation rather than to other inherent technological differences

Figure 5: Relationship Between Crush Loading and Average Load Factor

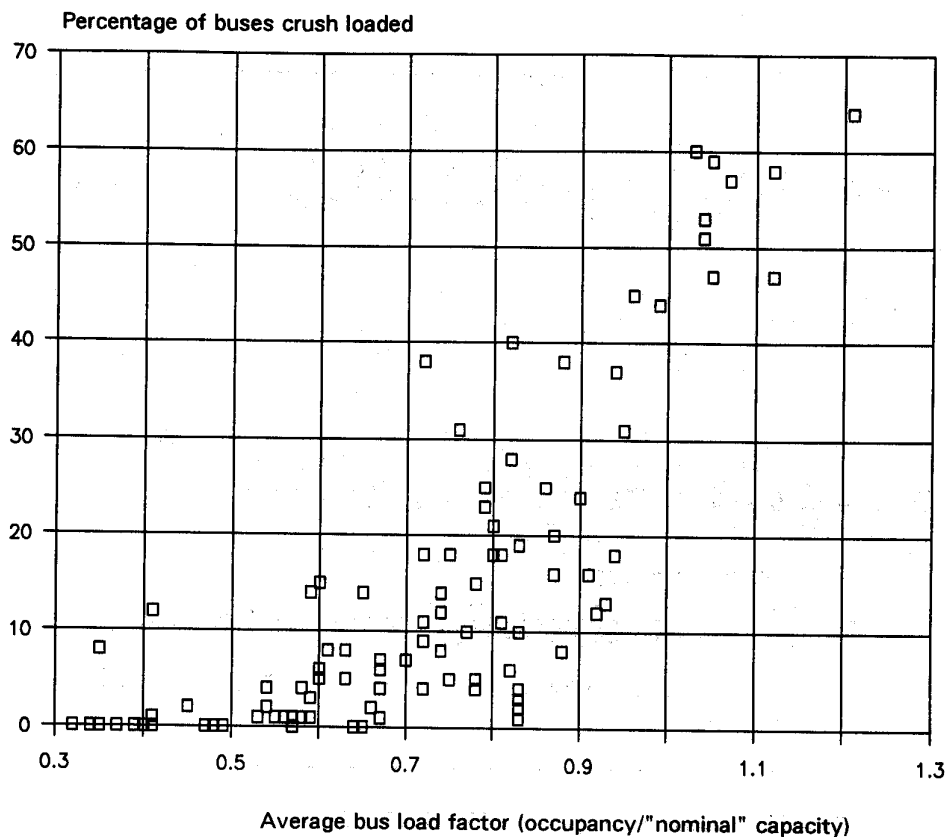

2.17 As noted in paragraph 2.10, the choice of route structure between trunk-and-feeder and an "open" system affects achievable load factors and other performance indicators. Trunk-and-feeder operations permit high line-haul passenger flows to be achieved, particularly with the use of high-capacity buses, but at the cost of enforced passenger interchange at expensive transfer stations. Open systems can serve a wider direct catchment area (without interchange), but the irregularity of bus arrivals and dwell times limits sustainable performance levels

REGULATORY FRAMEWORK

2.18 Busways function under a wide variety of regulatory arrangements. In Abidjan and Liege, for example, bus services are provided by a publicly-owned monopoly operator; in many Brazilian cities, including Sao Paulo, services are provided in a regulated environment by various private operators. In some cities, such as Curitiba, both public and private companies operate services as part of an integrated network, with a common fares policy, and with colour coding of vehicles according to

function. At present, no busways function in an entirely deregulated environment.

ORGANISATION AND MANAGEMENT

2.19 As indicated earlier, a basic busway can be used as a traffic management tool to segregate buses and other traffic. However, in order to develop a busway transit system which can offer high performance, special operational measures are required. Some measures necessitate suitable organisational and management arrangements in order to be effective, for example:

- management of the bus track - such as the provision of a tow truck to deal promptly with breakdowns.
- maintenance of the bus track, bus stop facilities and traffic control devices.
- fare collection and ticketing, possibly including off-board ticketing and management of season tickets or travelcards.

Figure 6: Capacity Determinants

RIGHT OF WAY CHARACTERISTICS
<ul style="list-style-type: none"> Road cross-section Degree of physical segregation from other traffic Junction design and control Horizontal and vertical alignment Road surface characteristics
BUS STOP CHARACTERISTICS
<ul style="list-style-type: none"> Overtaking facilities? Spacing Number of loading positions (bays) Platform storage area Passenger information Platform height
BUS CHARACTERISTICS
<ul style="list-style-type: none"> Vehicle size and capacity Existence and control of doors Number, location, width and use of doorways Number and height of steps Floor height Maximum speed Acceleration and deceleration rates
OPERATING CHARACTERISTICS
<ul style="list-style-type: none"> Route structure and scheduling Driver behaviour Fare structure and ticketing Trunk-and-feeder Bus Ordering (or convoys)
PASSENGER CHARACTERISTICS
<ul style="list-style-type: none"> Passenger demand, by stop Distribution, by time of day Behaviour
GENERAL TRAFFIC CHARACTERISTICS
<ul style="list-style-type: none"> Volume and nature Road user discipline Encroachments (e.g. hawkers)

Figure 7: Relationship Between Bus Stop Spacing and Commercial Speed

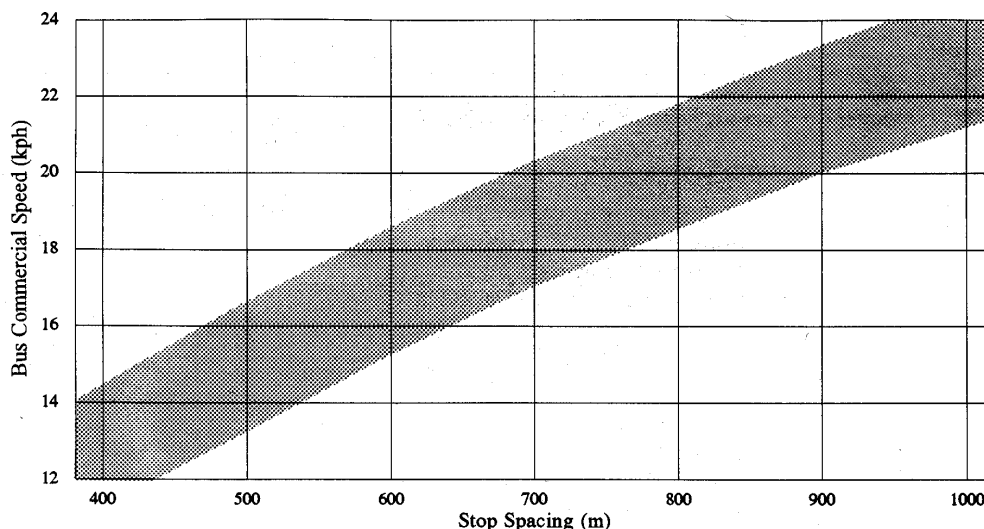

- driver training for the particular conditions associated with high-intensity operations.
- facilities and staff to undertake bus ordering, where appropriate
- provision of reliable and up-to-date passenger information.
- supervision to limit bus dwell times at busy stops in order to avoid excessive delays and service disruptions.

2.20 Whether these functions are to be performed by several agencies or by a single busway transit agency, specific arrangements must be made. Particular weaknesses which occur in practice are the fragmentation of responsibilities between the highway authority, bus operators and the police. This tends to lead to inadequate maintenance of busway infrastructure and to lack of "track management" where there are several competing operators

3. TRACK DESIGN

TRACK OPTIONS

3.1 Busway track may be located along an existing or a new right-of-way. For an existing right-of-way, the bus track may be located in the centre of the road (median) or along the sides (lateral), Figure 8 shows the principal configurations and Plates 6 and 7 show examples of lateral and median busways.

The relative advantages and disadvantages of median and lateral busways are summarised in Table 3.

A common objection to a median busway, and the associated of island bus stops, is that passengers have to cross more of the road than in the case of kerbside busway or bus lane. This is untrue - for a return journey to and from

any given point, a passenger has to cross the equivalent of one road width only; for a median busway, the passenger crosses half the width of the road on both the outbound and the return journey, whereas for a lateral busway, the passenger crosses the whole road width on one journey and not at all on the other (Figure 9).

3.3 As indicated earlier, the degree of grade separation between buses and other traffic can have a major influence on performance. The general arrangement for an elevated busway is given in Figure 10, and Plate 8 shows a section of elevated busway in Runcorn New Town. Plate 9 shows a tunnel in Belo Horizonte, Brazil, where buses have exclusive use of the lower level of the tunnel to pass under a hill between the city centre and suburbs.

Means of segregation

3.4 Some busways physically segregate buses and other traffic along their entire length using kerbs (e.g. Liege, Belgium -Plate 10) or fences (e.g. Sao Paulo, Brazil- Plate 11), while others have segregation only at island bus stops (e.g. Nagoya, Japan-Plate 12) or at island stops but with heavy studs between stops (e.g. Sao Paulo, Brazil- Plate 13).

Figure 8: Principal Busway Configurations

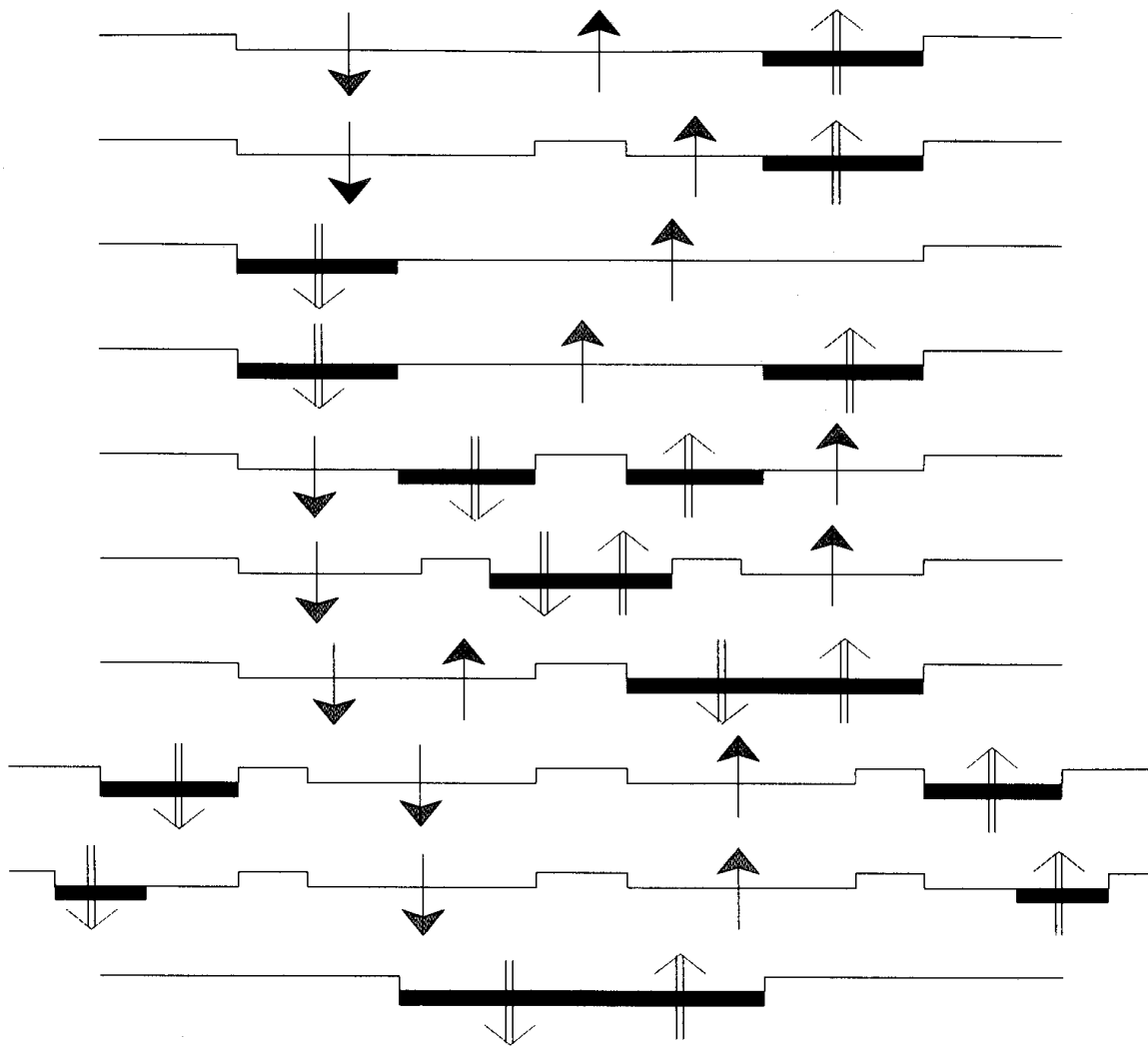

Key:

Busway



Direction of travel of general traffic



Direction of travel of buses



Plate 6 Lateral busway using one half of a dual carriageway: Istanbul

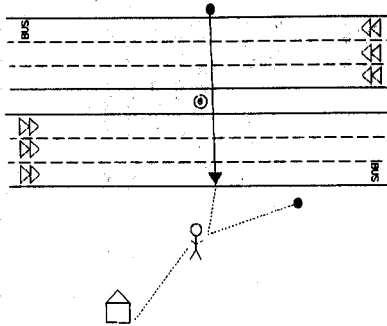

Plate 7 Median busway using the central reserve of a dual carriageway: Sao Paulo

Table 3: Advantages and Disadvantages of Alternative Busway Layouts

ADVANTAGES	DISADVANTAGES
<p>MEDIAN BUSWAY</p> <p>Allows frontage development to be serviced from kerbside either during off-peak or by night-time unloading/loading</p> <p>Experience shows that enforcement is not a major problem (even with separators which can be crossed by other traffic)</p> <p>If traffic volumes and network configuration permit, left-turn traffic can be accommodated by G or Q turns to resolve intersection design problems</p> <p>Traffic signal priority for buses facilitated as traffic turning across busway is limited.</p>	<p>Requires 10.5m minimum right-of-way for 2-lane busway, separators and island bus stops, plus adequate roadspace for general traffic (usually 2 lanes in each direction).</p> <p>Traffic management measures are necessary to ensure safe operation (eg median barriers for pedestrian control).</p> <p>If left turns are allowed across the busway, separate signal phases must be introduced.</p> <p>If stops are located mid-block, additional pedestrian/traffic signals will probably be required (causing extra vehicle delay).</p>
<p>WITH-FLOW, KERBSIDE BUSWAY</p> <p>Requires less space than for median busway since stops are located on existing footpath.</p> <p>Easier to provide bus overtaking facilities at stops than in case of median busway if bays can be provided in footpath.</p> <p>Although no firm data exist, pedestrian safety is probably greater than for median busway since passengers are not isolated in the centre of the road.</p> <p>Disruption to normal traffic routes is minimal.</p>	<p>Problems of servicing frontage development; this must be done from side streets or across the busway (difficult with high-volume schemes).</p> <p>Enforcement can be a problem unless separators cannot be crossed by general traffic (in which case problems might arise for broken-down buses).</p> <p>If the scheme extends to signal stop lines, separate signal phases must be provided (G and Q turns do not assist).</p>
<p>ADVANTAGES</p>	<p>DISADVANTAGES</p>
<p>CONTRAFLOW, KERBSIDE BUSWAY</p> <p>Minimises bus diversions in one-way road systems.</p> <p>Fewer enforcement problems than for with-flow busways, even with mountable separators.</p> <p>Easier to provide bus overtaking facilities at stops than in case of median busway if bays can be provided in footpath.</p>	<p>Problems of servicing frontage development; this must be done from side streets or across the busway (difficult with high-volume schemes).</p> <p>Initial accident problems involving pedestrians reported for several schemes.</p> <p>Introduction of contraflow busways into a one-way system may undermine the reasons for the one-way system itself, since conflicts would be reintroduced at intersections.</p>
<p>UNILATERAL, KERBSIDE BUSWAY</p> <p>Enforcement problems minimised.</p> <p>Easier to provide bus overtaking facilities at stops than in case of median busway if bays can be provided in footpath.</p>	<p>Feasibility depends upon frontage land-use; properties fronting the busway are isolated.</p> <p>Pedestrians must cross "3-way" traffic - with associated dangers.</p> <p>Special arrangements are required for bus entry and exit at intersections.</p>

Figure 9: Pedestrian Movements with Alternative Busway Types



Pedestrian crosses:

- 0 traffic lanes on outward journey
- 6 traffic lanes on return journey

TOTAL = 6 traffic lanes

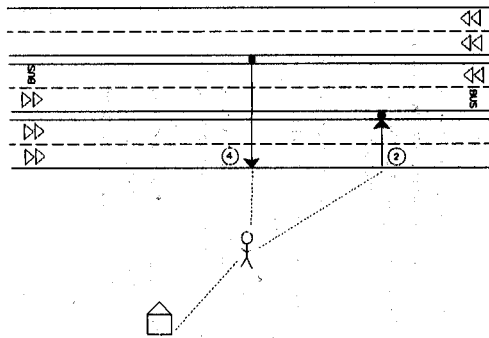

Pedestrian crosses:

- 2 traffic lanes on outward journey
- 4 traffic lanes on return journey

TOTAL = 6 traffic lanes

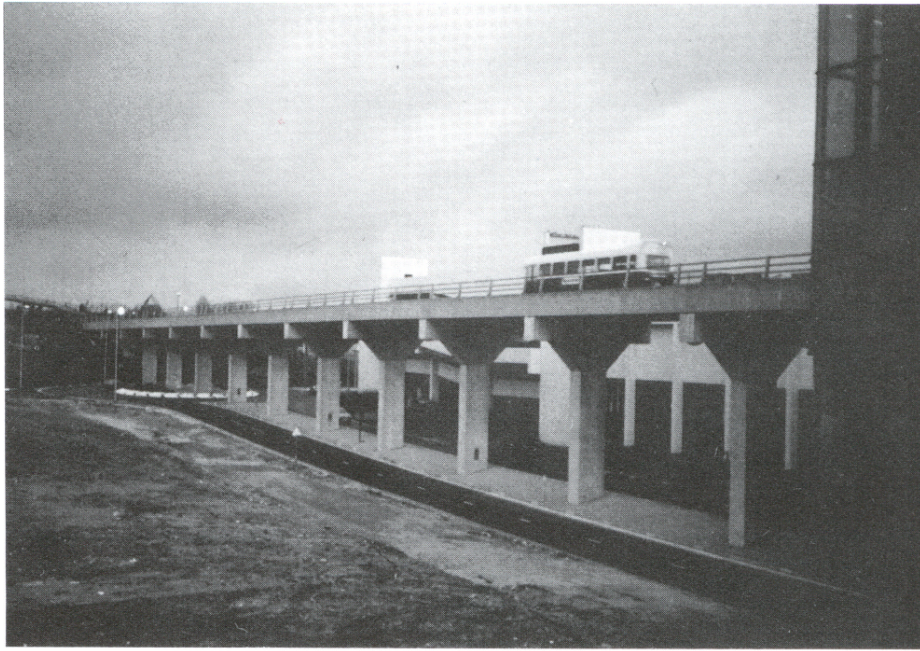

Plate 8 Elevated busway: Runcorn

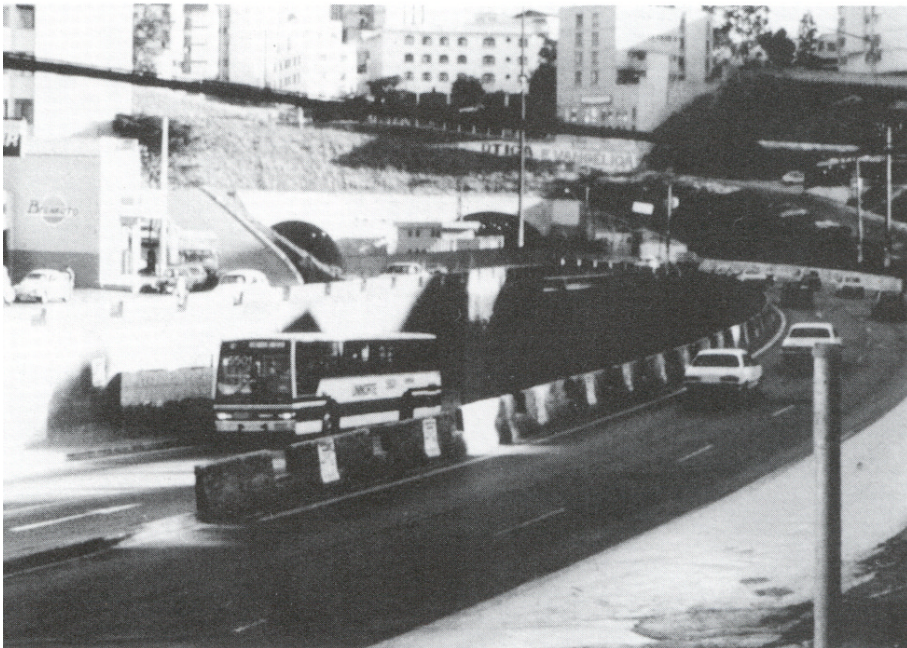

Plate 9 Busway tunnel: Belo Horizonte



Plate 10 Kerb separators: Liege



Plate 11 Fenced separators: Sao Paulo



Plate 12 Separation at bus stops: Nagoya

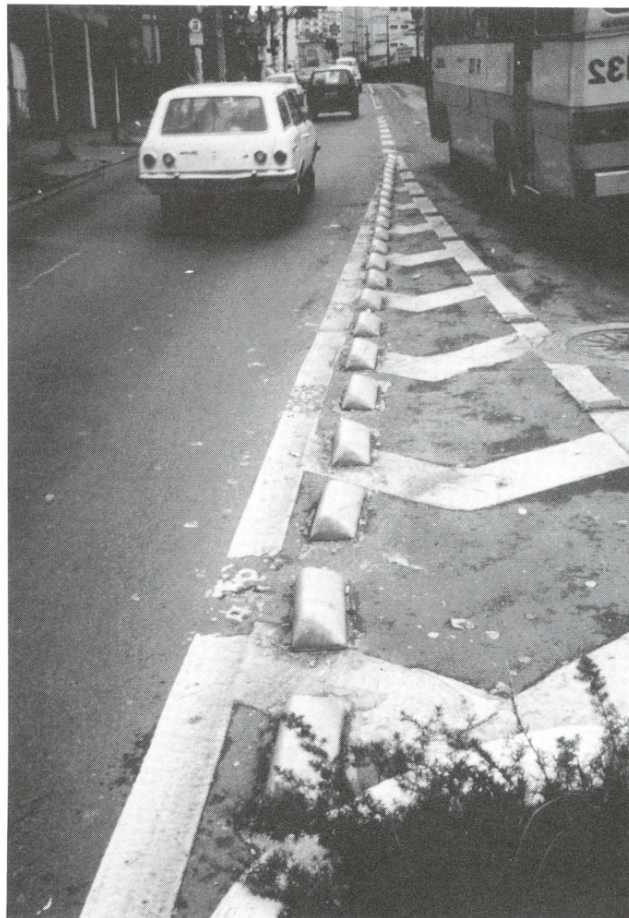

Plate 13 Studs used to separate

3.5 Where bus flows are high, it may be desirable to install a median barrier to dissuade pedestrians from crossing the busway at unauthorized locations. The barrier may be in the form of a fence or a New Jersey-type barrier.

Typical cross-sections

3.6 The width of a busway is dependent on design speed, vehicle width and operational characteristics. Typically, bus width is 2.5m and it is recommended that no bus lane should be less than 3.0m in width. Table 4 gives recommended lane widths for busways carrying in excess of 60 vehicles per hour, at different design speeds. In built-up areas of the city, design speeds are likely to be in the range 40-60 kmph. For express ways and grade-separated busways, higher design speeds may be practical. Lanes must be widened at curves to allow

for the fact that the rear wheels of a bus go through a smaller radius than the front wheels at road bends.

Horizontal and vertical alignment

3.7 It is recommended that curve radii and lateral banking is such that lateral accelerations do not exceed 1.0 m per sec. sq.; a more desirable level of lateral acceleration is 0.8 m per sec. sq.. Table 5 shows minimum radii for busways for different design speeds and street banking. The longitudinal incline of busways should be kept to a minimum, so as to maintain operational regularity, inflict minimum wear on vehicles, and provide travel comfort and general safety. Table 6 shows recommended maximum values for longitudinal inclines in relation to design speed. Near to intersections the longitudinal incline should be kept below 4 per cent.

Table 4: Recommended cross-section widths for median busways carrying more than 60 buses per hour

Design speed (km/h)	Width (m)			
	Bus lane	Central separator (between lanes)	Outer separator (between bus lane and other traffic)	Complete busway
100	4.00	0.4	0.75	10.30
80	3.75	0.4	0.50	9.30
60	3.25	0.4	0.30	7.90
40	3.00	0.4	0.20	7.20

(source: RATP)

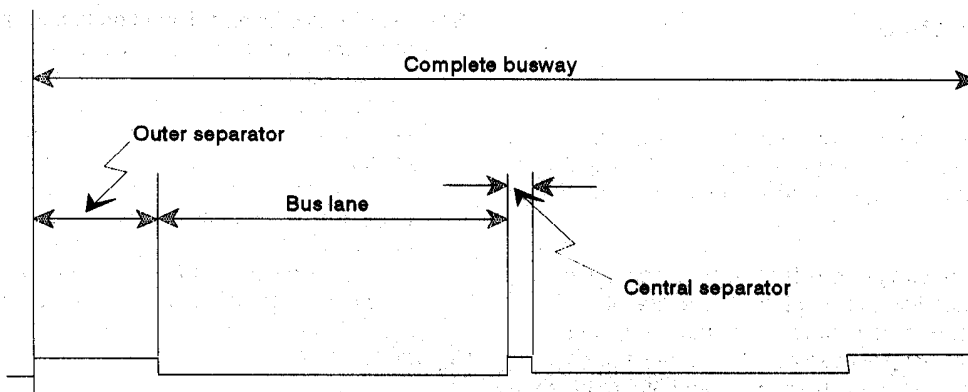

Table 5: Minimum Radii for Busways (metres)

Design speed (km/h)	Lateral acceleration (m/sec ²)	Banking		
		0%	5%	10%
		Radius (m)		
100	0.8	964	697	434
	1.0	771	517	390
80	0.8	617	388	278
	1.0	493	331	250
60	0.8	347	215	156
	1.0	278	186	140
40	0.8	154	96	69
	1.0	123	83	62

(source: RATP)

Table 6: Maximum Longitudinal Inclines for Busways

Design speed (km/h)	Open road %	On ramps or Under difficult conditions %
100	4.0	4.0
80	4.0	6.0
60	4.5	6.5
40	5.5	10.0

(source: VOV/VDA)

INTERSECTIONS

Layouts

- 3.8 Some typical intersection layouts for median and lateral busways are illustrated in Figure 11. Detailed layouts will depend upon local geometrics and traffic flows.
- 3.9 Where the busway or bus lane does not continue up to the stop line (as with the UK practice of providing set-backs in order to maintain stop line capacity), pre-signals can be used to manage the queue such that buses reach the head of the queue and traffic entering the junction can be controlled within its capacity (Figure 12).

- 3.10 In order to minimise disruption to busway operations, the number of roads crossing the busway is usually limited to main thoroughfares only. Kerbs or barriers may be placed to prevent traffic turning across the busway into or out of minor side roads. In such cases, side road traffic is restricted to right turn in/right turn out (right hand rule of the road) and "Q" and "G" turns are used to concentrate traffic onto a limited number of cross routes. Such arrangements have an impact on local access, which needs to be considered very carefully

Signal control

- 3.11 A high degree of traffic signal control is generally required in order to manage high bus and general traffic volumes, without excessive delays. Signals

Figure 11: Typical Intersection Layout

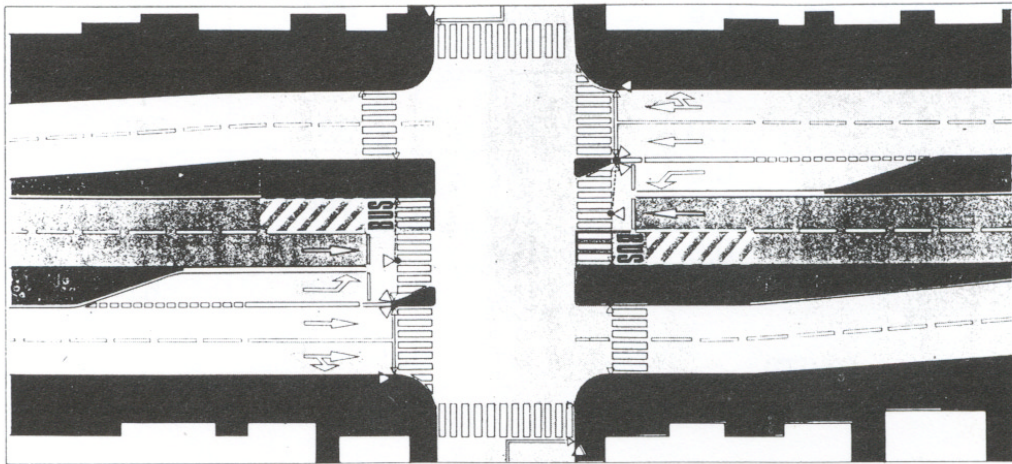

(i) Median busway

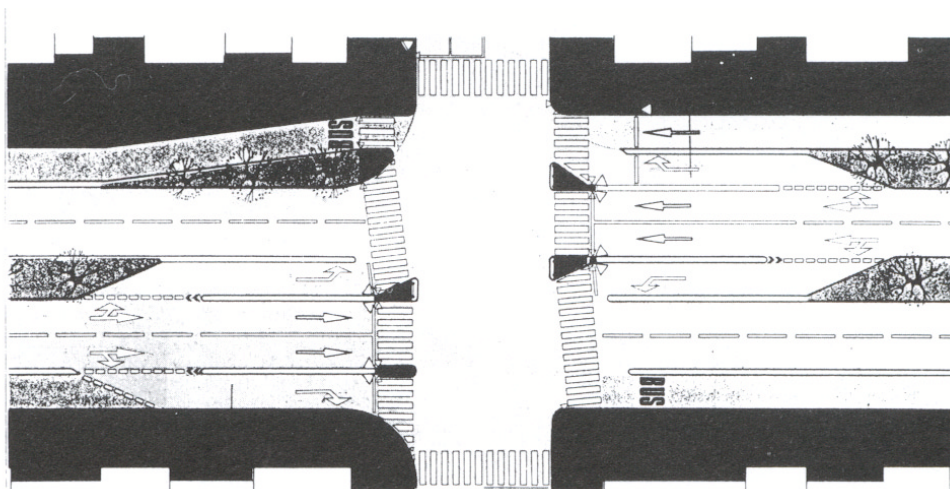

(ii) Lateral busway

Source: RATP

Figure 12: Presignals/Bus Advance Area

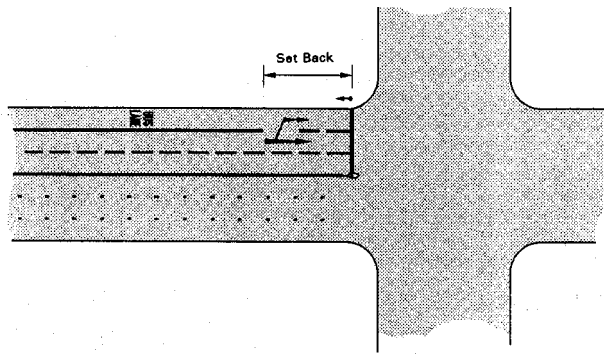

Bus Lane with "Traditional" Set Back

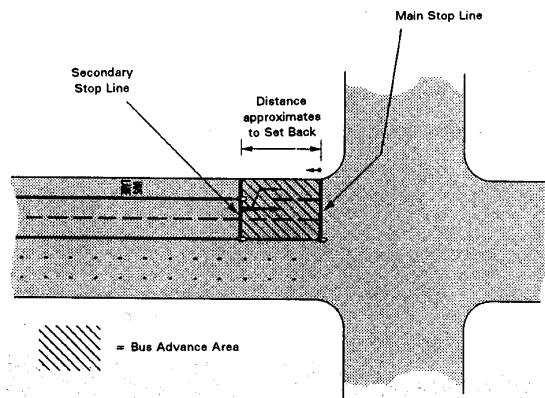

Bus Lane leading to Bus Advance Area

may also be required to control pedestrian crossings. Signal control can be used to aid bus movements in the following ways.

- selective detection of buses to extend a green phase or to recall a green phase.
- demand dependent stages (which enables a bus to call a stage which would not otherwise occur).
- signal time biasing to favour a stream with a high proportion of high-priority vehicles
- "gating" in order to manage queues in favour of high priority vehicles.

COLLECTOR/DISTRIBUTOR SYSTEMS

3.12 It is important to organise suitable collector and distributor systems to feed buses onto the busway and to permit them to leave the busway, without undue congestion. The capacity of the collector and

distributor systems should at least match the bus demand at the relevant locations. This can be difficult where one or more busways lead into a city centre - in such cases, special arrangements are needed to disperse high bus volumes into terminals or onto a circulation system composing bus roads or lanes. The use of a range of bus priority techniques in and around a city centre will usually be essential to enable a busway to function effectively.

GUIDANCE SYSTEMS

3.13 Considerable publicity has been devoted to "guided busways". A guided busway is simply a busway equipped with a guidance mechanism (tracks) to enable buses to travel at speed in a relatively narrow right-of-way. One form of guided busway - "O-Bahn" - has been built in Essen, Germany, and in Adelaide, Australia (Figure 13); another system - "Guided Light Transit (GLT)" - operates in Rochefort, Belgium.

Figure 13: O-Bahn Track Dimensions

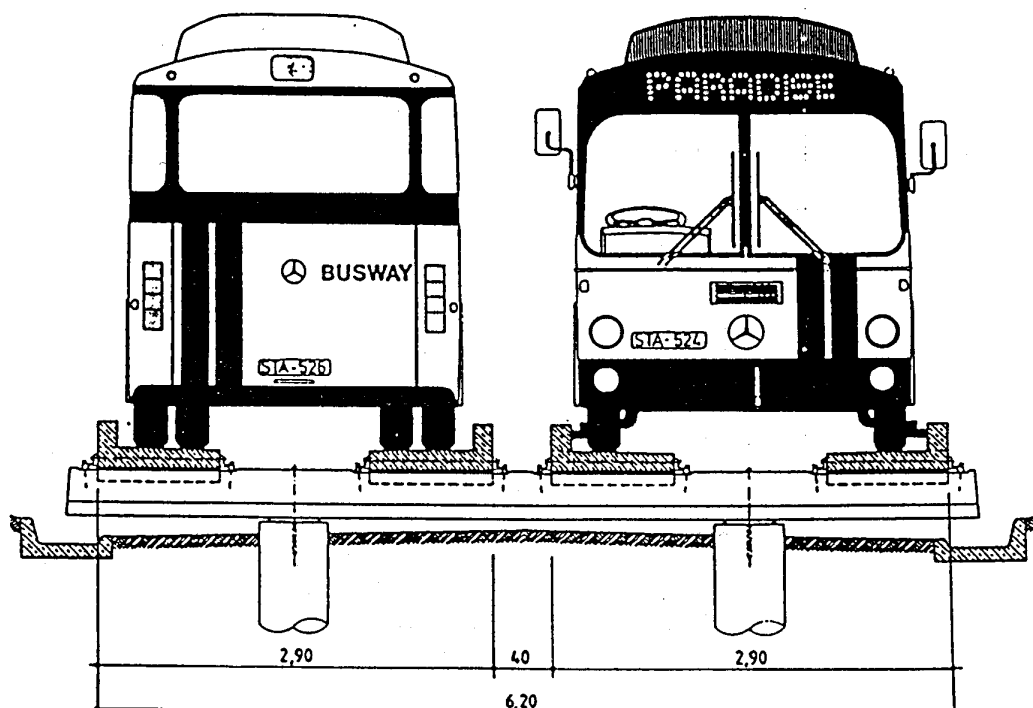

Source: VOV/VDA 1977

3.14 The prime advantages of a guided busway compared to a conventional busway are'

- the track provides a permanent physical presence, which makes the system more "visible" to politicians and public alike.
- where the right-of-way is severely constrained, or land values are high, guided busway can operate between junctions in a right-of-way about 1 metre narrower than that of a conventional busway; however, this advantage is lost at functions (where capacity is usually critical) in the case of guidance systems which require an entry splay.
- guideways enable buses to pass in opposite directions at high speed in a reduced right-of-way.
- the track "occupies" the right-of-way and makes violation by other vehicles extremely unlikely.

3.15 The prime disadvantages are the additional cost compared to a conventional busway and the severance effect in urban areas. It appears that the prime locations for guided busway would be in suburban areas requiring high-speed operations.

3.16 Guided busway can offer broadly equivalent levels of service to light rail transit, but at much lower capital cost. Guided busway has the advantage over light rail transit that the vehicles can leave the track and so offer door-to-door service over a wide catchment area, without enforced passenger interchange.

OTHER ASPECTS

3.17 Particular attention needs to be given to the design and construction of the road pavement because of repeated loadings by heavy vehicles at bus stops and at traffic signal stop lines. It will often be

desirable to provide concrete slabs at stops, in order to avoid the sort of pavement creep illustrated in Plate 14

- 3.18 Where enforcement is expected to be a particular problem, due to poor road user discipline, physical and electronic measures are available to dissuade other vehicles from entering the busway. Plate 15, for example, shows a "barrier", which by its shape and dimensions inhibits the passage of vehicles other than buses.

4. BUS STOPS

BUS STOP DESIGN

Capacity

- 4.1 Traffic behaviour at bus stops is extremely complex and relatively little is known about bus stop capacity. In developing cities, up to about 6,000 passengers/hour may board or alight at a busy bus stop. The highest number of boarding passengers recorded in the TRL surveys of busways (Gardner et al, 1991) was some 3,600/hour during the morning peak at the KCR station bus stop in Hong Kong; the highest recorded number of alighting passengers was at Osmanbey, Istanbul, with 4,000/ hour during the morning peak.
- 4.2 Based on survey results, and judgmental assessments, three bus stop categories are defined (in terms of passenger handling volume) for design purposes:
- **Very High Volume:** either boardings or alightings greater than or equal to 2,500/hour.
 - **High Volume:** maximum of boardings or alightings less than 2,500, but greater than or equal to 1,000/ hour.
 - **Intermediate Volume:** boardings and alightings less than 1,000/hour.

Design considerations

- 4.3 Both the design of the bus stop, and the operational procedures at the bus stop, will affect both its capacity and that of the busway system. Thus, any design feature which enables buses to enter and leave the stop without bus congestion will be beneficial, as will any measure which enables passengers to board and alight rapidly. Often the design and operational measures complement one another. For example, bus stops may be "orderly", where bus bays are marked and used 9, or "disorderly", where buses stop one or more times "on-demand" along a length of kerbside. Disorderly stops can achieve high bus and passenger flows, but at the expense of passenger inconvenience and safety. Sometimes one objective of a busway scheme is to "order" the flow of buses and

passengers (e.g. Bogota, Colombia).

- 4.4 The main features of bus stop design which will affect capacity of the system are:
- the number of bus bays provided.
 - the order in which buses stop (including the allocation of bus routes to bays).
 - facilities for buses to overtake one another (and thus to avoid blockages).
- 4.5 The number of bus bays at each stop on a busway transit system will typically vary between one and six, depending on the transfer demand. These bays can be either 'on or off-line'. On-line bays allow no special overtaking facility; the buses stop on the busway track. Off-line bays have a stopping area which is separate from the main running track; as a result buses can easily overtake one another at bus stops. To reduce the level of interaction between passengers waiting for different bus services, bus bays can be ordered (as noted above). In such an ordered system bus services or routes would be designated to particular bays, for example, a four bay stop might have its first two bays for route (or group of routes) A and its remaining two for route (or group of routes) B. This is denoted AA-BB. Figure 14 shows some examples of these design options; indicative capacities, based on TRL analyses, are given in Table 7.

Layouts

- 4.6 Quite clearly, the capacity of a bus stop (and the busway system) will be affected by its layout; category one bus stops (very high volume transfer) will almost certainly need multiple off-line bays, which are ordered in some way. Category three bus stops will require less demanding conditions: probably on-line, single or double bay which may not have to be ordered. Figure 15 shows a number of bus stop designs: a typical layout of an "on-line" bus stop (i.e. without an overtaking lane), on a median busway in Curitiba, Brazil; a similar bus stop type in Porto Alegre, but with staggered bus stops to minimise right-of-way requirements. Experience in Porto Alegre suggests that the stops should be staggered such that to reach the pedestrian crossing, alighting passengers should have to walk in the same direction as the bus.
- 4.7 The overtaking facility required for category 2 and 3 bus stops can be achieved in various ways: for example, by the provision of two lanes at bus stops (e.g. Sao Paulo - Plate 4), off-line bays (e.g. Belo Horizonte - Plate 16 and Figure 15), or parallel bus stop islands (e.g. Singapore - Plate 17 and Figure 16)



Plate 14 Pavement creep along a busway



Plate 15 Busway entry barrier

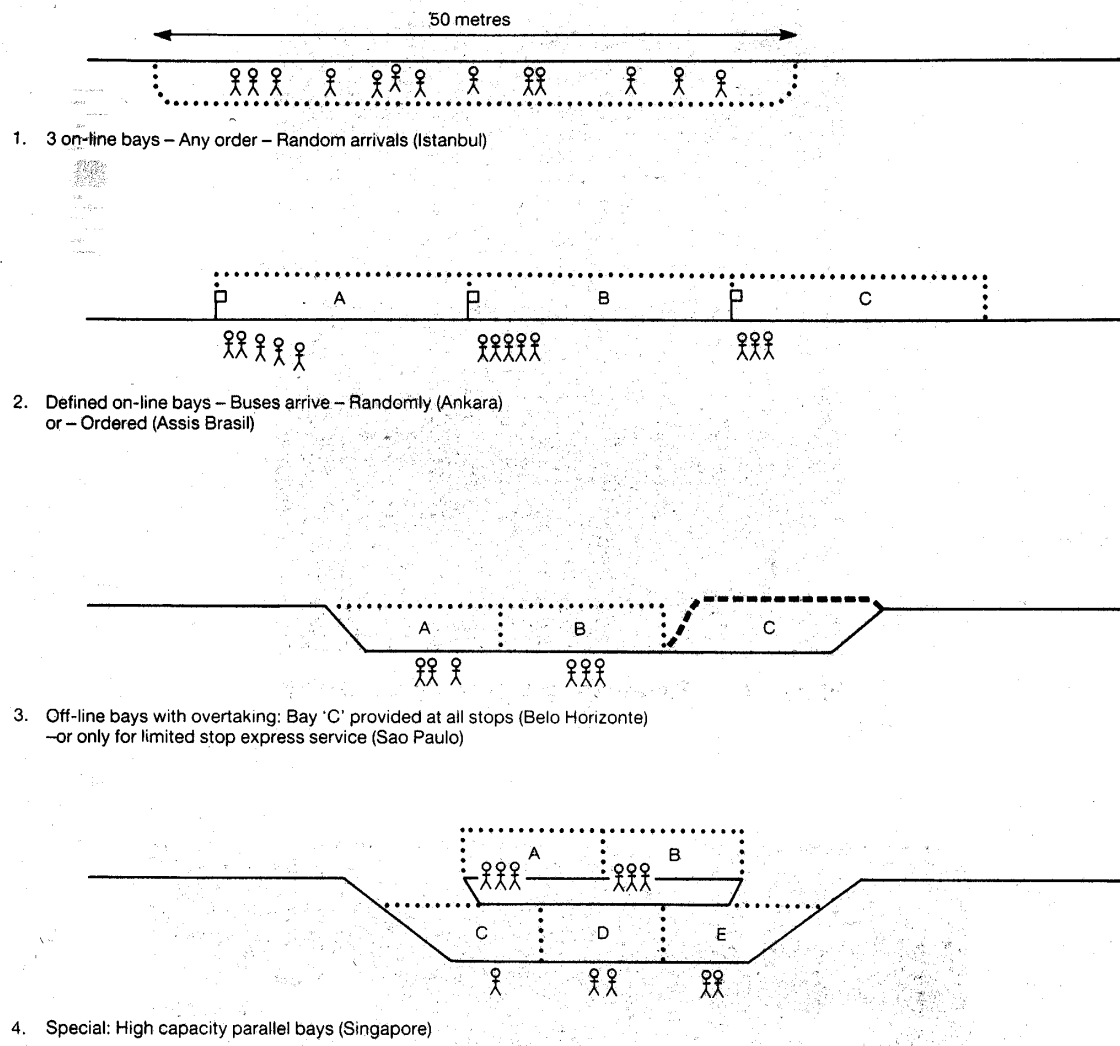

Figure 14: Some Examples of Bus Bay Layouts used in Case Study Cities

Table 7: Indicative Bus Stop Capacities

Estimated performance of bus stop options – high passenger transfer demands – at-grade

No. of Bays	Use of Bays	Description	Bus Type	Maximum Available Passenger Places/h/d	Maximum Passengers/ Hour/ Direction	Maximum Buses/ Hour/ Direction	Ave. Bus Time Through Stop (sec)
<i>Basic options</i>							
2	Any	–	Standard	11200	7400	111	148
3	A-B-C	–	Standard	8800	6000	87	245
3	Any	–	Standard	17500	11600	173	81
4	AA-BB	–	Standard	15000	9700	148	135
6	AAA-BBB	–	Standard	17000	11200	168	149
4	AA-BB	–	High-capacity	21000	14800	148	136
<i>High-capacity options</i>							
4	AA-BB	Bus ordering	Standard	16300	10600	161	81
6	Any	Trunk-and-feeder/pre-payment	Standard	22300	15200	220	57
4	Any	Trunk-and-feeder/pre-payment	High-capacity	29100	21200	205	68
6	AAA-BBB	Overtaking/Express services	Standard	28100	18800	278	60
4	AA-BB	Overtaking/Express services	High-capacity	33200	23900	234	80
4	AA-BB	Overtaking/Express services/pre-payment	High-capacity	36800	26700	260	77

Notes: (1) See TRRL Report RR329 for standard definitions and assumptions (Gardner, et al, 1991)
 (2) High passenger transfer demand corresponds to 1,500 boarding passengers/hour

Figure 15: Bus Stop Configurations

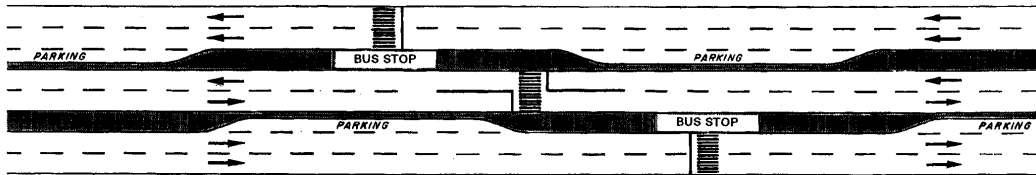

(i) On-line bus stop: Curitiba

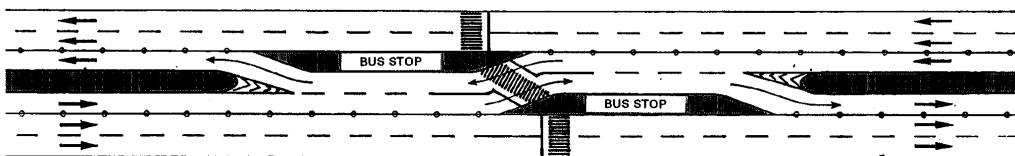

(ii) On-line bus stop: Porto Alegre

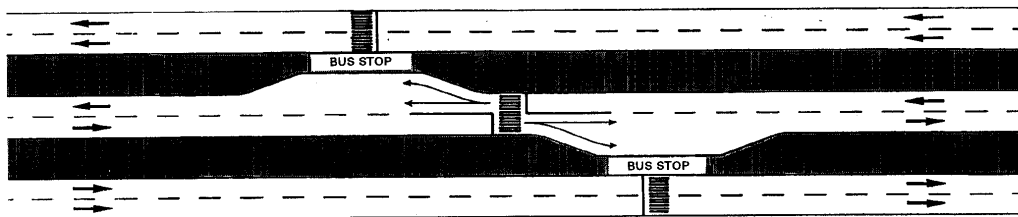

(iii) Off-line bus stop: Belo Horizonte



Plate 16 Off-line bays: Belo Horizonte

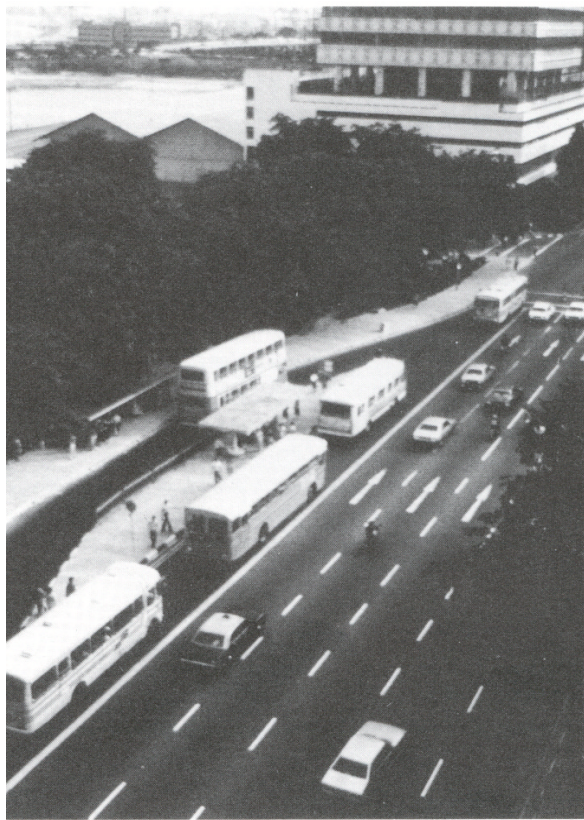

Plate 17 Parallel bus bays: Singapore

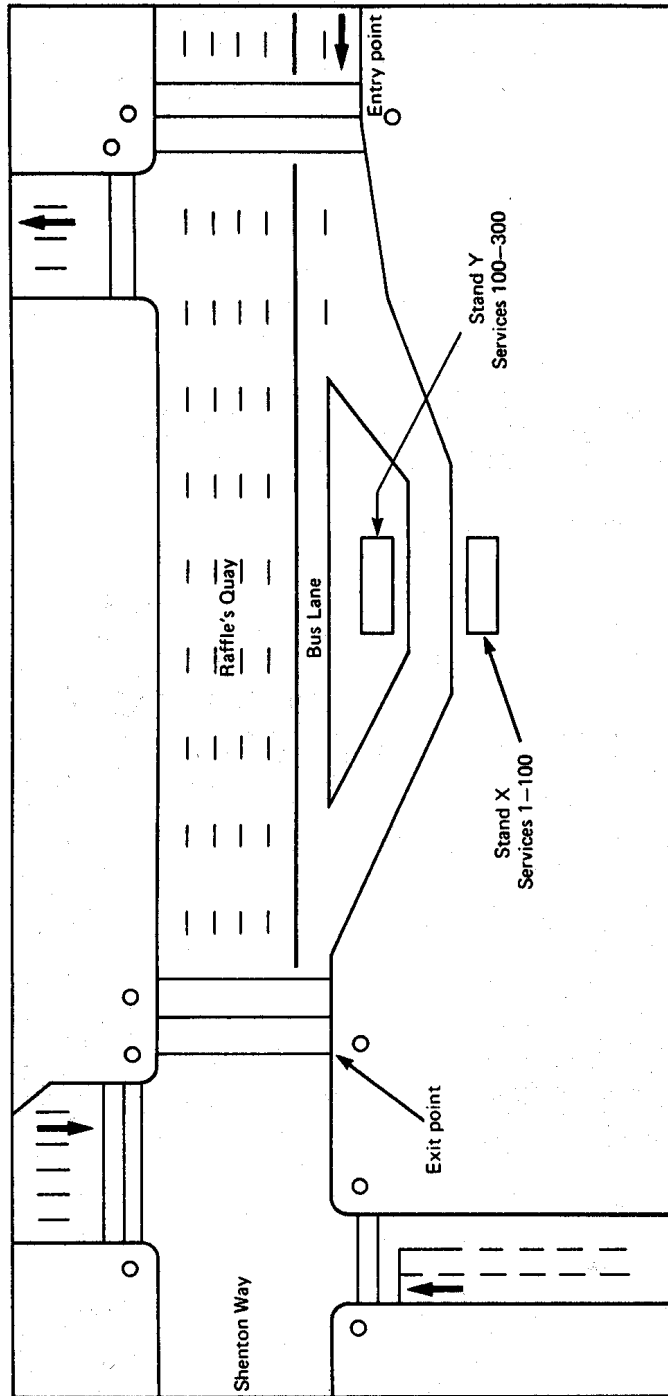

Figure 16: Bus Stop Layout, Raffle's Quay, Singapore

BUS STOP SPACING

- 4.8 Bus stop spacing should be chosen in relation to the density of passenger demands, the locations of large traffic generators, road geometrics and the level of service required. As indicated in Section 2, stop spacing has a large influence on commercial speed (Figure 7), with high performance being associated with relatively longer stop spacings

BUS STOP LOCATION

- 4.9 The relative locations of traffic signals and bus stops should be determined in relation to local circumstances. However, substantial bus delays can occur where a traffic signal is located immediately downstream from a bus stop. This is because without signal pre-emption, it frequently occurs that a bus completes loading, but the traffic signal shows red. The bus is obliged to wait in the bus bay until the signal turns to green, even though other buses may be waiting to enter the stop. The following buses therefore suffer a traffic signal delay before even reaching the bus stop and, at the intersection, may incur further delays.
- 4.10 Placing a bus stop immediately downstream from a traffic signal controlled junction can also cause problems at high bus volumes, because buses queuing to enter the stop may back-up and block the junction (depending upon bus driver training and discipline). Successful design will involve combined consideration of signal design, passenger demand and bus flow in relation to bus stop location. The provision of grade-separated pedestrian crossings can be considered, particularly where bus stops are located mid-block. However, enforced climbing of stairs may be unpopular with passengers.

5. EVALUATION

DEFINITION OF OPTIONS

- 5.1 Comparison of bus and rail mass transit options can present problems because of the different characteristics of the two systems. In particular rail systems require a depot (usually in a suburban location because of land requirements) and a substantial track length before they can be effective and attract passengers, whereas busway systems can be developed incrementally. Furthermore, rail mass transit is a "closed" system in which all the costs of infrastructure and rolling stock can be attributed to the system, whereas busway transit is an "open" system in which buses may use the busway on only a minor part of the route length, making definition of "the system" and cost allocation difficult.

- 5.2 It will often be unreasonable to compare the costs and benefits of bus and rail systems over identical route lengths, because bus priorities are only required in congested areas; elsewhere, buses can run on all purpose roads with general traffic, i.e. no special facilities are required. The total length of infrastructure required will therefore be different.
- 5.3 Bus and rail transit options also have implications for movement patterns and land development: by their nature, rail systems tend to concentrate passenger flows (especially where bus services are "integrated" with rail) whereas bus transit tends to offer a more dispersed pattern of movements. Evaluation of these effects depends upon the land use-transport strategy of the particular city.

BUSWAY TRANSIT COSTS

Capital costs

- 5.4 Out-turn cost data for existing busway schemes vary according to design standards, construction procedures, initial condition of the roadway, local inflation rates, exchange rate variations, and so on. However, a typical at-grade, partially segregated busway track might cost of the order of US\$ 1 million/km (1989 values), excluding vehicles and terminals, based on the following assumptions.
- no land acquisition would be required and existing road kerblines would not be moved.
 - the existing median would be removed in order to allow busway construction.
 - existing road drainage would be adequate and would not be modified.
 - the existing road pavement would be adequate except in the bus stop area, where complete reconstruction would be required.
 - no extensive diversion of public utilities would be required.
- 5.5 General guidelines for the cost of an elevated busway pose even greater difficulties than those for an at-grade busway, due to the wide range of possible construction techniques, foundation conditions, bus stop treatments and other features. There is little direct experience of the cost of elevated busways since no extensive sections have been constructed, although several are under consideration (e.g. Karachi). Based on UK conditions, a representative elevated busway is estimated to cost of the order of £10 million (US\$17 million) per km (1989 values). The approach being taken in several current proposals for elevated schemes is to consider elevation only where traffic capacity at selected junctions is critical. Clearly if bus stops can be accommodated at-grade, considerable cost savings are possible.

5.6 The physical quality of most existing busways is not high and this is reflected in the above cost estimates. For example, passenger facilities (stops; shelters; crossings; passenger information systems) are often extremely basic and of low quality, and consequently have a poor image. The bus track is often poor, since existing pavements are often retained in bus stops areas in order to minimise costs. In several existing busways, pavements have deteriorated due to tracking (e.g. Istanbul; Porto Alegre) and in some cases, the pavements have failed (e.g. Abidjan; Recife). The costs of improving the physical quality of an at-grade busway would not be great. The public image would be enhanced, scheme life would be prolonged and maintenance costs reduced. Even with such improvements, the per km costs would still be substantially below those of an equivalent light rail transit (LRT) system.

5.7 The costs of associated infrastructure will vary from place to place and will depend on local requirements. The cost of a footbridge might typically be the order of US\$80-100,000. Where a comprehensive busway transit system is to be implemented, new depot and workshop facilities may be required, particularly if high-capacity buses are to be introduced. Again, costs depend upon many local factors, but a new depot for about 200 buses could cost in the region of US\$6-8 million (excluding land costs). A workshop and central stores facility might cost a similar sum, depending upon the scale of facilities required. (Cost estimates 1992 US dollars unless stated otherwise).

5.8 If a trunk-and-feeder system is to be operated, transfer terminals will be needed along the main axes together with a terminal station at the end of each corridor. Costs depend upon many local factors but could be of the order of US\$500,000 for a basic transfer station and US\$800,000 for a basic terminal station (excluding land costs). The out-turn costs of the various high-quality terminals in Curitiba, for example, were of the order of US\$ 1 million for each transfer station and US\$3 million for each terminal. However, terminals may offer development opportunities and additional sources of revenue.

5.9 The infrastructure costs of atgrade busways are generally low compared to those of other segregated mass transit modes: the typical busway track infrastructure costs of the order of US\$1 million per km compares with estimated costs for mass transit railways (including rolling stock and other equipment) in the range US\$8-27 million/km (1987 values) for at-grade construction, US\$22-60 elevated and US\$50-165 underground (Fouracre et al, 1990).

5.10 In Ottawa, it was estimated that the capital cost of a busway system would be 68% of the cost of a comparable light rail system. Figures for Pittsburgh

indicate the cost of the city's busways were of the order of US\$5 million/km for the South corridor and US\$10 million/km for the East corridor, compared with some US\$27 million/km for the city's LRT (Kain et al, 1990). In Auckland, corridor studies compared LRT and O-Bahn options and the findings suggest that the capital cost of an O-Bahn would be about half that for a comparable LRT (Auckland Regional Authority, 1988). In Adelaide, where an O-Bahn has been implemented, preliminary design estimates suggested that for comparable LRT, busway and O-Bahn systems (including track, control systems, depots, rolling stock etc.) the costs of the conventional busway and O-Bahn systems would be 58% and 65% respectively of that of an LRT system (Wayte, 1988).

5.11 In developing countries, the foreign exchange requirement of a proposed investment can be an important criterion in the selection of a technology. Busway transit offers considerable scope for construction by local contractors and, where a local assembly or body-building industry exists, a substantial part of bus costs can be incurred locally.

Operating costs

5.12 Estimated operating costs of busway transit are in the range 8-12 US cents per passenger km. (from Armstrong-Wright, 1986, with costs factored to 1993 prices). The key components are labour, energy and replacement materials.

THE IMPACT OF BUSWAY TRANSIT

The users

5.13 The majority of beneficiaries of busway transit in developing cities are likely to be existing public transport users; there has been no evidence of any major switching to bus from private modes, as a result of the introduction of priority measures in the industrialised world (although few cities have extensive, high quality, bus priority systems.) There are strong conceptual grounds for believing that most private vehicle users in developing cities are unlikely to be attracted to use of public transport; these travellers come mainly from high income groups, who will value comfort and convenience of personal transport very highly.

5.14 Many earlier studies have attested to the level of user benefits which result from bus priority measures. Typical time gains in European and North American cities, measured over the length of schemes, range between 20-50 per cent. Similar observations have also been noted in Singapore, Bangkok and Porto Alegre, in the latter, journey times were reduced by 29 per cent. Small improvements in regularity have also been noted. Busways can result in improvement in the quality of travel, particularly if the investment includes new rolling stock which is clean and comfortable. There is

anecdotal evidence from Curitiba and Nagoya that a high quality system will generate new passengers in addition to attracting transfer from other modes.

Transport operators

5.15 Busways can help to reduce bus operating costs in several ways

- bus commercial speeds can be raised by removing buses from general traffic congestion and, since bus operating costs are speed-related, operating costs can be reduced.
- because buses can achieve higher average speeds, fewer buses are required to operate a given service, thus saving in capital costs.
- busway transit may generate opportunities for scale economies which might not otherwise be feasible (e.g. use of high-capacity vehicles).

Non-users

5.16 It is impossible to generalise about the effects of introducing a busway into an existing road network. In a dense road network, a busway may influence traffic flows and journey times both along the busway corridor and on adjacent roads. In such cases, some form of network modelling is required to assess the possible reassignment of general traffic. And in any event, some form of junction analysis will be required to estimate the effects of the new junction arrangements on junction capacity and delays (e.g. using software such as SATURN, OSCADY etc).

5.17 In some cases, the improved traffic management associated with bus priorities has led to travel time gains for both buses and general traffic (e.g. Bangkok). In Abidjan, introduction of a median busway across the city centre was perceived to have benefits to both the bus operator ("independence from general traffic") and to general traffic ("getting buses out of the way of cars"). Nevertheless, where a busway or bus lane continues up to a signals stop line, in order to give buses priority, there will be some loss of capacity for general traffic. This may be offset by gains to buses and passengers but the effect must be examined on a case by case basis in relation to person throughput, traffic flows and residual capacity.

5.18 Busways (and transit systems in general) are often promoted on the basis that they can contribute to relief of city centre traffic congestion through encouraging a modal switch from private to public transport. The evidence for success in this objective is, unhappily, not strong, most users of the busway will not have switched modes, but will be using a bus which has simply switched from an unreserved to a reserved track within the same right-of-way. Even where there may have been a switch from private to public transport, the improved traffic

conditions on the road network will quickly induce new car traffic to emerge.

5.19 However, there are reasonable grounds for supposing that busways (in common with other mass transit) could have some influence on the spread of traffic congestion. With increasing car ownership and use, city centre traffic congestion reaches what has been described as the threshold of the intolerable, it cannot get any worse, and assuming all traffic engineering measures have been exhausted, can only spread more widely, rather than more deeply. New roads to access the city centre may improve the situation, but there are limits to what can be achieved, simply because the land is not available and the resulting environmental damage is likely to be too great. A mass transit system, making the best use of the existing road system, provides the capacity needed to access the city centre, without the associated penalties of road building. In providing greater access, the mass transit system helps to reduce the spread of traffic congestion.

5.20 The environmental impacts of any particular scheme will require detailed assessment in the light of scheme characteristics and local circumstances. Busways, by their nature, provide a high-speed track in built-up areas where pedestrian activity will be intense. The resulting severance, safety, noise and air pollution effects all warrant particular attention. Severance effects can be minimised, and safety enhanced, by suitable urban design and by the provision of adequate pedestrian crossing facilities. Some busways have been designed so as to minimise the interaction of pedestrians and vehicles; but pedestrian crossing points are inevitably necessary (if only to access the busway), as is interaction with other traffic at grade junctions and along unprotected rights-of-way.

5.21 On-street noise and air pollution effects of busway transit can be minimised through the use of modern, LPG (liquid petroleum gas) or CNG (compressed natural gas) powered buses, or electric powered trolleybuses.

5.22 Because of the severance effect of any at-grade median transit system (bus or rail), local access requires particular attention. Strict parking, waiting and loading controls will be required in order to ensure adequate servicing and roadspace is available for moving traffic along the corridor.

Urban development

5.23 The essence of a city centre is that it is the most accessible point from both within and without the city. This accessibility is important for many activities, and in particular for those central functions which serve a wide area and/or need a wide labour market: head offices, central government offices and legal institutions, financial institutions, media firms, theatres, department stores, etc. and all the

supporting organisations (catering, hotels, etc.) that exist to serve these central functions. The fortunes of the city centre are at risk if the public transport system proves inadequate in supporting these central functions. In most developing cities, the majority of commuters to/from the centre depend almost exclusively on road-based public transport. If the city centre becomes congested (because too much traffic is occupying too little road space), then its relative accessibility may suffer, because the public transport system cannot perform effectively. As a result, new central functions will be discouraged from locating in the city centre and old established ones may start to drift away. Clearly, there is an intimate and vital relationship between the well-being of the city centre and its public transport system which should never be overlooked. For this reason, it is becoming increasingly apparent that urban transport development in the major cities may be reaching a stage where priorities have to be imposed, and mode choice has to be managed to the advantage of public transport systems; the limited supply of road space feeding the city centre is exhausted, and the only possible relief would seem to be through the development of a mass transit system, like busway transit, which makes best use of the available road space.

- 5.24 Apart from promoting the performance of public transport, and thereby contributing to the healthy growth of the city, mass transit systems may have their own intrinsic developmental impact on a city. Mass transit schemes have sometimes been proposed to enhance or encourage new city development and/or renewal. For example, it is reported that the development of the LRT in Manila has played a key role in shaping the urban development of the metropolis, triggering the redevelopment of the traditional centres of business and trade, and encouraging commercial growth along its route. This impact of mass transit is not fully understood and has not always worked, in particular where planning controls on urban development are weak. Generally, if a city has a buoyant economy then a mass transit system can contribute to and accentuate that condition by removing accessibility constraints; on its own, however, the mass transit system can do little. Thus ideally busways should be developed in unison with other on-going major developments within the city.
- 5.25 A number of mass transit schemes have managed to capture some developmental benefits for their own financial gain. This has been achieved through the commercial development of the air-space above terminals and interchanges; these revenues can contribute to both the capital cost of the structure and/or to general income.

Other impacts

- 5.26 Public transport is often used by people who do not have access to private, motorized transport including children, old people and women. This means

that improvements to transit services can have important social impacts. For example, suitable bus services can offer mobility to women who may not otherwise have access to motorized transport, and can increase their access to work opportunities, and to educational and social activities.

- 5.27 In developing countries, the foreign exchange requirement of a proposed investment can be an important criterion in the selection of a technology. Busway transit offers considerable scope for civil engineering construction by local contractors and, where a local assembly or body-building industry exists, a substantial part of bus costs can be incurred locally.

ECONOMIC EVALUATION

- 5.28 An economic analysis of any busway project should try to take account of all the impacts which have been discussed. Many of these impacts are clearly difficult to quantify. A busway scheme is likely to improve bus commercial speeds and reliability, and therefore the potential benefits are typically: journey time savings to bus passengers (including the value of increased reliability), and bus operating cost savings (including a possible reduction in fleet size). In general, the majority of benefits are likely to be associated with time savings at junctions. However, the analysis should also take into account changes in journey times and operating costs for other road users, especially if some reassignment of traffic is anticipated. Depending upon local geometry and traffic flows, introduction of a busway may increase or decrease the capacity available for general traffic, particularly at junctions, and detailed junction analyses are required to estimate these effects.
- 5.29 Finally, no study has examined the crucial issue of the developmental benefit to the city centre of a busway scheme. It is a very complex issue since it raises questions about the city structure and its efficient growth; these are questions which go beyond the bounds of urban transport planning, and pose major conceptual and technical problems of analysis. If the continued growth of the urban centre is an urban development objective then the busway scheme can be considered as a major positive contribution to achieving that end.

6. REFERENCES AND BIBLIOGRAPHY

- ALLPORT R J and J M THOMSON, 1990. Study of mass rapid transit in developing countries; *TRRL Contractor Report 188*. Crowthorne : Transport Research Laboratory.
- ARMSTRONG-WRIGHT A, 1986. Urban transit systems: Guidelines for examining options. *World Bank Technical Paper No 52* Washington DC: World Bank.

- AUCKLAND REGIONAL AUTHORITY, 1988. Auckland Comprehensive Transportation Study Update Stage 2 Report.
- CHIN H C and Y TANABORIBOON, 1984. Dwell times of buses in Singapore; Proceedings of the 2nd Conference on Mass Transit in Asia. Singapore.
- CORNWELL P R and J A CRACKNELL, 1990. The case for busway transit; PTRC 18th Summer Annual Meeting. London: PTRC
- CRACKNELL J A, P R CORNWELL and G GARDNER, 1990. Study of bus priority systems in less developed countries: In CODATU V, Sao Paulo. Paris: CODATU Association.
- CUNDILL M A and P F WATTS, 1973. Bus boarding and alighting times. *TRRL Report LR521*. Crowthorne: Transport Research Laboratory.
- DALUORTO A, 1989. Evaluacion de pastas exclusivas para buses en Lima: In CEPAL Conference Proceedings, Havana, Cuba.
- DEPARTMENT OF TRANSPORT, 1991. Keeping buses moving; *Local Transport Note 1/91*. London: HMSO.
- EBTU, 1982. Manual Tecnico - Tratamento preferencial ao transporte colectivo por onibus; Empresa Brasileira dos Transportes Urbanos. Brazilia: EBTU.
- FOURACRE P R, R J ALLPORT and J M THOMSON, 1990. The performance and impact of rail mass transit in developing countries *TRRL Research Report 278*. Crowthorne: Transport Research Laboratory.
- GARDNER G and P R FOURACRE, 1990. Busway transit - the TRRL study; PTRC 18th Summer Annual Meeting. London: PTRC.
- GARDNER G, P R CORNWELL and J A CRACKNELL, 1991. Performance of high-capacity bus systems. *TRRL Research Report 329*. Crowthorne: Transport Research Laboratory.
- GIBSON J, I BAEZA and L WILLUMSEN, 1989. Bus stops, congestion and congested bus stops. *Traffic Engineering & Control*, June 1989.
- HOUNSELL N B, 1988. Bus stop siting at road junctions. *TRRL Contractor Report 89*. Crowthorne: Transport Research Laboratory.
- KAIN J F, R GITTELL, A DANIERE, S DANIEL, T SOMMERVILLE and L ZHI, 1990. Increasing the productivity of the nation's urban transportation infrastructure: measures to increase transit use and carpooling. Draft Final Report. Washington, DC: UMTA.
- LINDAU L A, 1987. Bus priority systems in Brazil: from theory to practice; PTRC Summer Annual Meeting. London: PTRC.
- MARLER N W, 1982. The performance of high-flow bus lanes in Bangkok. *TRRL Supplementary Report SR723*. Crowthorne: Transport Research Laboratory.
- MERCEDES-BENZ DO BRASIL, 1987. Sistema de transporte colectivo urbano por onibus, planejamento e operacao
- MERCER J, 1966. Rapid transit system basic design standards - 2nd Edition; Runcorn Development Corporation.
- NATO, 1976. Bus priority systems. CCMS Report No45; NATO Committee on the Challenges of Modern Society. Crowthorne: Transport and Road Research Laboratory.
- NELSON J D and P J HILLS, 1990. Innovative bus control for congested urban corridors: the application of convoying systems *Traffic Engineering & Control Vol 31(5)*.
- PRETTY R L and D J RUSSELL, 1988. Bus boarding rates. *Australian Road Research 18(3)* pp145-152. September 1988.
- RATP, 1977. Autobus en site propre. Paris: Regie Autonome des Transports Pansiens.
- SZASZ P A, L de C MONTANS and A R GODOY. COMONOR combos de onibus ordenados nas Avenidas Rangel Pestana a Celso Garcia. *CET Technical Bulletin No 22*. Sao Paulo: Companhia de Engenharia de Trafego.
- TANABORIBOON Y, K K CHIN and H C CHIN, 1986. Performance of bus lane in Singapore - a case study. Paper presented to 13th ARRB/5th REAAA Conference
- TRB, 1975. Bus use of highways: planning and design guidelines. Report 155, Transportation Research Board, National Research Council. Washington, DC: Transportation Research Board.
- TRRL, 1987. Field survey techniques and analysis for urban bus operators. *Overseas Road Note 4*. Crowthorne: Transport Research Laboratory.
- TRRL, 1988. A guide to geometric design. *Overseas Road Note 6*. Crowthorne: Transport Research Laboratory.
- TRRL, 1990. Busway transit video. *TRL Video V254*. Crowthorne: Transport Research Laboratory.
- URBAN EDGE, 1991. Busways gain ground. *The Urban Edge Vol 15(4)*. Washington, DC: World Bank.
- VINCENT R A, R E LAYFIELD and M D BARDSLEY, 1976. Runcorn busway study. *TRRL Laboratory Report LR 697*. Crowthorne: Transport Research Laboratory.
- VOVNDA, 1982. Bus transit system. Verband offentlicher Verkehrsbetriebe (VOV)Nerband der Automobilmindustrie. V. (VDA).

VUCHIC V R, 1981. Urban public transportation systems and technology. New Jersey. Prentice-Hall Inc..

WAYTE F A, 1988. Cost comparisons of busway, light rail and guided bus. In Proceedings of the International Seminar on Guided Bus Rapid Transit, Adelaide, October 1988.

WHITE P, 1986. Public transport: its planning, management and operation. London: Hutchinson.
TRANSPORT RESEARCH LABORATORY

