

# OVERSEAS ROAD NOTE 1



***Road maintenance management for  
district engineers***





TRL Limited  
Old Wokingham Road  
Crowthorne, Berkshire, RG45 6AU



Department for International Development  
1 Palace Street  
London, SW1E 5HE

# **Overseas Road Note 1**

## **Road maintenance management for district engineers**

First published 1981  
Reprinted with minor revisions 1983  
Second edition 1987  
Third edition 2003  
ISSN 0951-8797  
**Copyright TRL Limited 2003.**

<i>Subsector:</i>	Transport
<i>Theme:</i>	T2
<i>Project title:</i>	Overseas Road Note 1: Maintenance Management for Regional and District Engineers
<i>Project reference:</i>	R7781

This document is an output from a project funded by the UK Department for International Development (DFID) for the benefit of developing countries. The views expressed are not necessarily those of the DFID.

TRL is committed to optimising energy efficiency, reducing waste and promoting recycling and re-use. In support of these environmental goals, this report has been printed on recycled paper, comprising 100% post-consumer waste, manufactured using a TCF (totally chlorine free) process.

## **The Department for International Development: a brief mission statement**

The Department for International Development (DFID) is the UK Government department responsible for promoting sustainable development and reducing poverty. The central focus of the Government's policy, based on the 1997 and 2000 White Papers on International Development, is a commitment to the internationally agreed Millennium Development Goals, to be achieved by 2015. These seek to:

- Eradicate extreme poverty and hunger
- Achieve universal primary education
- Promote gender equality and empower women
- Reduce child mortality
- Improve maternal health
- Combat HIV/AIDS, malaria and other diseases
- Ensure environmental sustainability
- Develop a global partnership for development

DFID's assistance is concentrated in the poorest countries of sub-Saharan Africa and Asia, but also contributes to poverty reduction and sustainable development in middle-income countries, including those in Latin America and Eastern Europe.

DFID works in partnership with governments committed to the Millennium Development Goals, with civil society, the private sector and the research community. It also works with multilateral institutions, including the World Bank, United Nations agencies, and the European Commission.

DFID has headquarters in London and East Kilbride, offices in many developing countries, and staff based in British embassies and high commissions around the world.

DFID, 1 Palace Street, London SW1E 5HE

DFID, Abercrombie House, Eaglesham Road, East Kilbride, Glasgow G75 8EA

Tel: +44 (0) 20 7023 0000

Fax: +44 (0) 20 7023 0019

Public Enquiry Point: 0845 300 4100 (from outside the UK: +44 1355 84 3132)

DFID website: [www.dfid.gov.uk](http://www.dfid.gov.uk)

Email: [enquiry@dfid.gov.uk](mailto:enquiry@dfid.gov.uk)

## ACKNOWLEDGEMENTS

The principal author of this edition was Dr Richard Robinson, now an independent consultant, with contributions from Simon Done, Dr Greg Morosiuk and Dr John Rolt of TRL Limited. The example of field survey procedures described in Appendix B is based on one developed by High-Point Rendel.

## OVERSEAS ROAD NOTES

Overseas Road Notes are prepared principally for road and transport organisations in developing countries. A limited number of copies are available to other organisations and to individuals with an interest in road management, and may be obtained from:

Centre for International Development

TRL Limited

Crowthorne

Berkshire, RG45 6AU

United Kingdom

[www.trl.co.uk](http://www.trl.co.uk)

Limited extracts from the text may be reproduced provided the source is acknowledged. For more extensive reproduction, please contact TRL using the postal or website address above.

## Foreword

A good road network is vital for the development of any country, and particularly so for most developing countries. Rural areas are the home for large numbers of people, the farms which produce crops for consumption and export, and strategic sites such as power stations and border posts. However, rural roads, along with other rural facilities, often receive less than their fair share of spending and many fall into disrepair. Communities become isolated and lose their access to schools, health centres, social support networks and sources of income. At the same time, teachers and medical staff are unable to visit the rural facilities where they do their work. Crops cannot be transported to markets and much needed income is lost. Rural poverty grows and livelihoods become unsustainable.

To reverse this trend, rural roads must be well managed, money must be spent efficiently and the needs of the road users – farmers, villagers, traders and government officials – must be met. This is good road management and, if carried out in tandem with other institutional improvements, should bring about sustainable improvements in the livelihoods of the rural population. This document is aimed at providing suitable guidance for road managers so that they can manage their rural road networks more effectively.

In many rural areas roads fall into two groups. The first carry very low volumes of motorised traffic, but social use is vital and significant. The second group carry higher volumes of traffic and economic use is dominant. This document is applicable to both groups but is intended primarily for the second group. Additional considerations are needed for very low volume roads and these are dealt with more fully in Overseas Road Note 20.

Martin Sergeant

Head of Profession  
Infrastructure and Urban Development  
DFID



# CONTENTS

	Page
<b>1 Introduction</b>	1
Purpose and scope	1
Structure of the Note	2
<b>2 Road network management</b>	3
Aims	3
Activities	3
Management cycle	6
<b>3 The role of the maintenance engineer</b>	8
<b>4 Network information</b>	10
Information needs	10
Classification	10
Network definition	10
Item inventory	12
Content and preparation	12
Recording	13
Updating	13
Presentation	13
Traffic	16
<b>5 Assessing needs</b>	17
Defects	17
Safety inspections	18
Network screening surveys	19
Visual inspections	19
<b>6 Determining options</b>	21
Basis of approach	21
Scheduled treatments	21
Condition-responsive treatment selection for unpaved roads	25
Condition-responsive treatment selection for paved roads	26
Diagnosing the cause of deterioration	26
Specifying the work required	33
<b>7 Choosing actions</b>	34
Selection from among options	34
Resource estimation	34
Choice of work method	34
Choice of technology	34
Procurement by contract	36
In-house works	37
Estimating	38

	Page
Costing	38
Works packaging	43
Priority assessment	44
Purpose	44
Example method	44
Alternative prioritisation methods	46
Determining the work programme	47
<b>8 Preparation and operations management</b>	<b>49</b>
Works design	49
Procurement by contract	49
Forms of contract	49
Specifications	50
Contract procedures	51
Operations management of in-house works	52
<b>9 Monitoring and audit</b>	<b>57</b>
<b>10 Information systems</b>	<b>59</b>
<b>References</b>	<b>60</b>
<b>Appendix A: Glossary</b>	<b>62</b>
<b>Appendix B: Field survey procedures</b>	<b>67</b>
<b>Appendix C: Traffic counts</b>	<b>82</b>
<b>Appendix D: Standard forms</b>	<b>85</b>
<b>Appendix E: Illustrations of defects</b>	<b>92</b>

# 1 Introduction

---

## Purpose and scope

1.1 This Note is a practical guide to the management of road maintenance. It provides a rational approach to help maintenance engineers organise and control the activities for which they are responsible. The aim is to improve effectiveness and efficiency, and make more productive use of maintenance resources. The Note is targeted primarily at those district engineers in developing and emerging countries who do not have access to computer-based information and management systems. However, although a paper-based system of management is described, this could easily be computerised using simple spreadsheets, if required. Parts of the Note may also be used in conjunction with existing computer-based systems.

1.2 The Note covers the management of ‘maintenance’ and ‘renewal’ activities, but does not cover ‘development’ (new construction, widening, new carriageway works), or ‘rehabilitation’ to restore deteriorated roads to a maintainable condition. Winter maintenance is not included. It covers ‘programming’, ‘preparation’ (treatment design and works procurement) and ‘operations management’. It does not cover ‘strategic planning’. The Note can be applied to the management of single-carriageway asphalt-surfaced and portland cement concrete roads carrying up to about 5,000 vehicles per day. It can also be applied to gravel and earth roads. It covers carriageway and off-carriageway features of roads in rural areas. The Note can also be applied in urban areas, but some particular problems of urban roads (street lighting, urban drainage, permits for utility openings, traffic management, etc.) are not covered. Advice on bridge inspection is given separately in *Overseas Road Note 7* (TRRL 1988) and on traffic safety management in *Towards safer roads in developing countries* (TRRL 1991) and *Highway safety guidelines* (IHT 1990).

1.3 Management of road network maintenance and renewal can be considered to have the following objectives:

- Network safety:
  - complying with statutory obligations to provide minimum safety standards.
  - meeting users’ needs by reducing safety risks to an acceptable level.
- Network serviceability:
  - ensuring availability so that roads or traffic lanes are not closed for unacceptably long periods.
  - achieving integrity by applying consistent standards along routes, including consistent signing.
  - maintaining reliability by providing a ‘level of service’ that meets users’ needs for mobility.
  - enhancing quality of all aspects of the driving environment.
- Network sustainability:
  - minimising cost over time to both road users and the road administration.
  - maximising value to the community and minimising environmental damage.
  - maximising environmental contribution.

1.4 The Note offers advice on techniques basic to good management practice, but does not set out to define ‘model’ systems that should be copied generally. It does not describe all the management procedures an ideal road administration should follow. This is because, in any location, the best management system will be one that is matched closely to the technical skills, human resources and equipment available, and the most effective procedures will be those that are appropriate to the experience and capabilities of its staff. Using this Note, engineers will be able to assess the range of management techniques applicable to road maintenance and renewal, and so identify methods that can usefully be put into practice within the context of their own organisations.

## **Structure of the Note**

1.5 Following this introduction, Chapter 2 sets out the key management activities to be undertaken and Chapter 3 summarises the responsibilities of the maintenance engineer. Chapter 4 describes basic information about the road network that is needed to underpin these activities. The management activities are described in more details in Chapters 5 to 9, which explain each stage of the process in turn. Chapter 10 discusses the use of computer-based road information and management systems. A glossary of terms is included as Appendix A. Other appendices provide additional details of some of the technical procedures and give examples of standard forms. A final appendix illustrates typical defects found on roads.

## 2 Road network management

---

### Aims

2.1 Road network management is a process that attempts to optimise the overall performance of the road network over time. The process comprises a number of ‘activities’ (or measures) that will have ‘impacts’ (or effects) on the road network. Impacts include those on the following:

- Level of service or road conditions.
- National development and socio-economic issues.
- Road user costs.
- Accident levels and costs.
- Environmental degradation.
- Road administration costs.

2.2 The way in which road maintenance and renewal address these impacts should be set out in a ‘road maintenance policy’. This should be part of the road administration’s ‘roads policy’, which defines aims, objectives and performance indicators for the organisation as a whole. The road maintenance policy should define aims and set objectives in each of the above six impact areas. Objectives should be specific, measurable, achievable, relevant and time-bound, and should reflect the relative importance of each of the areas of impact. In the absence of a pre-defined organisational policy, the engineer should take the initiative to formulate an appropriate road maintenance policy. Guidance on this is included in *Road maintenance management: concepts and systems* (Robinson and others 1998).

2.3 A key aspect of policy formulation is involvement in this of road users, as ‘customers’ of the road administration. Road users will often have a different perspective on the importance of different impacts than will officials of the road administration or elected members, and it is important to reflect this in the roads and road maintenance policy. In some countries, existence of a ‘roads board’ provides an easy opportunity for such user consultation. However, the ‘political’ dimension is also important, and elected members should also be involved in the policy formulation process.

2.4 The objectives included in the road maintenance policy provide the basis for deriving ‘standards’ and ‘intervention levels’ that can be used to provide the detailed operational criteria for determining maintenance treatments (see Section 6).

### Activities

2.5 Activities on pavements and shoulders can be defined under the headings of ‘operations’, ‘maintenance’, ‘renewal’, ‘development’ and ‘disposal’, as in Table 2.1. ‘Operations’ are ‘management’ activities; ‘maintenance’, ‘renewal’ and ‘development’ are ‘works’ activities. Similar groupings of activities can be defined for other features, such as bridges and structures, footways and cycle tracks, street lighting, road signs and furniture.

2.6 Activities can be broken down into ‘tasks’ for the purposes of operational costing and management. For example, surface dressing might be broken down into the tasks of:

- i Place signs and traffic control devices.
- ii Prepare existing surface and carry out any pre-patching.
- iii Ensure surface is clean and free from loose material by brushing.
- iv Mask surface iron-work.

**Table 2.1 Activities related to road pavements and shoulders**

<i>Group</i>	<i>Category</i>	<i>Type</i>	<i>Examples of activities</i>
Operations.		Network management.	<ul style="list-style-type: none"> <li>• Strategic planning.</li> <li>• Programming.</li> <li>• Preparation (design and procurement).</li> <li>• Operations management.</li> </ul>
		Administration.	<ul style="list-style-type: none"> <li>• Finance and accounts.</li> <li>• Personnel management.</li> </ul>
		Facilities management.	<ul style="list-style-type: none"> <li>• Toll collection.</li> <li>• Maintenance of depots.</li> </ul>
		Policing.	<ul style="list-style-type: none"> <li>• Speed enforcement.</li> <li>• Axle load control.</li> </ul>
Maintenance.	Routine planned.	Cyclic.	<ul style="list-style-type: none"> <li>• Grass cutting.</li> <li>• Cleaning side drains.</li> </ul>
	Routine unplanned.	Reactive.	<ul style="list-style-type: none"> <li>• Patching.</li> <li>• Crack sealing.</li> </ul>
		Winter.	<ul style="list-style-type: none"> <li>• Salting/gritting.</li> <li>• Snow removal.</li> </ul>
		Emergency.	<ul style="list-style-type: none"> <li>• Traffic accident removal.</li> <li>• Landslip removal.</li> </ul>
	Periodic (planned).	Preventive.	<ul style="list-style-type: none"> <li>• Fog seal.</li> <li>• Slurry seal.</li> </ul>
		Resurfacing.	<ul style="list-style-type: none"> <li>• Single surface dressing.</li> <li>• Thin overlay.</li> </ul>
		Road marking.	<ul style="list-style-type: none"> <li>• Renew road markings.</li> </ul>
Renewal.		Overlay.	<ul style="list-style-type: none"> <li>• Structural asphalt overlay.</li> <li>• Bonded concrete overlay.</li> </ul>
		Pavement reconstruction.	<ul style="list-style-type: none"> <li>• Mill and replace.</li> <li>• Inlay.</li> </ul>
Development.		Widening.	<ul style="list-style-type: none"> <li>• Lane addition.</li> <li>• Shoulder provision.</li> </ul>
		Realignment.	<ul style="list-style-type: none"> <li>• Local geometric improvement.</li> <li>• Junction improvement.</li> </ul>
		New section.	<ul style="list-style-type: none"> <li>• Dualling.</li> <li>• By-pass construction.</li> </ul>
Disposal.		Asset disposal is seldom used in connection with pavements and shoulders except in a few cases of 'de-gazetting' of a road.	

- v Apply bituminous binder.
- vi Apply chippings.
- vii Roll.
- viii Re-expose iron-work by removal of masking.
- ix Apply lines and markings.
- x Remove signs and traffic control devices.

2.7 The term ‘rehabilitation’ is sometimes used to refer to the works necessary to restore a road that has not been maintained back to a ‘maintainable’ condition. This differs from ‘renewal’ which is an expected activity that should be planned for as part of a normal asset management regime. Rehabilitation normally requires pavement overlay or reconstruction, plus reconstruction of drainage and other road-side features. Often, the opportunity is taken to carry out some ‘development’ activities at the same time as rehabilitation.

2.8 Network management activities (sometimes referred to as ‘management functions’) can be described in more detail under the following four headings:

- *Strategic planning* – long-term decisions affecting the whole of the road network, undertaken primarily for the benefit of senior managers and policy-makers (not covered by this Note).
- *Programming* – determining those parts of the road network where work can be undertaken with available resources in the next budget period.
- *Preparation* – design of works for individual sections of road, issuing of contracts or works orders for works for which there is a budget commitment.
- *Operations management* – managing and supervising on-going works on individual sub-sections of road.

2.9 For funding purposes, works are normally assigned to ‘budget heads’. These are often termed ‘capital’ and ‘recurrent’ although, in some countries, other budget heads are also used. Both maintenance and renewal works should be funded from the recurrent budget. However, often, periodic maintenance and renewal works are assigned to the capital budget. This reduces the flexibility to optimise management of the network over the life cycle of the roads. However, maintenance engineers must work within whatever budgeting procedures are in place in their organisation.

2.10 In many countries, ‘budgeting’ is carried out on an annual cycle. Budgeting is part of the ‘programming’ activity. Initially, this is used to produce a programme of required works under each budget head, listed in priority order (see Section 7). This programme is submitted for approval to the budget authority (often the Ministry of Finance). An approved programme is then authorised, and a budget awarded for its implementation. The maintenance engineer can then produce a list of committed works, which can be prepared for execution. Budgeting procedures differ from country-to-country and from organisation-to-organisation. They are not discussed further here.

2.11 The programme of committed works is implemented throughout the year. The maintenance engineer arranges how best to do this, in terms of both method of procurement and timing. Determining the best timing for works is known as ‘scheduling’. Procurement and scheduling are discussed in Section 8.

2.12 This Note is concerned with the network management activities of programming, preparation and operations management, related to the works of maintenance and renewal for the features of pavements, shoulders, drainage and road furniture.

## **Management cycle**

2.13 All maintenance management activities can be carried out by using the following steps, which are known as the 'management cycle':

- i Define aims (what is the required objective of the activity?).
- ii Assess needs (how does the current situation fall short of the required aim?).
- iii Determine options (what alternative approaches can be used to address the identified need?).
- iv Choose actions (which option should be adopted?).
- v Implement (carry out the activity to meet the aim).
- vi Monitor and audit.
  - review how well the outcome of the implementation actually meets the aim – to provide feed-back on how the setting of aims can be improved in the future.
  - review to see if the implementation procedures can be improved.
  - ensure that the implementation has been undertaken in the correct technical manner and that money has been spent properly.

2.14 Table 2.2 shows the management cycle steps for the network management activities of programming, preparation and operations management, and indicates where aspects are described in more detail in this Note.

**Table 2.2 Management cycle for programming, preparation and operations management**

<i>Steps in the management cycle</i>	<i>Network management activity</i>			
	<i>Programming</i>	<i>Preparation (see Section 8)</i>		<i>Operations management (see Section 8)</i>
		<i>Design</i>	<i>Procurement</i>	
1 Define aims.	Determine work programme that can be carried out with next year's budget.	Design of works.	Issue of contract or work instruction.	Undertake works activity.
2 Assess needs.	Measure road conditions for renewal, periodic and routine reactive works (see Table 2.1) (see Section 5).	Detailed surveys and investigations to assess road conditions.	Confirm work type to be undertaken.	Determine the extent and quantity of work from: detailed inspections for renewal, periodic and routine reactive works; from the maintenance standard for routine cyclic works.
3 Determine options.	For renewal, periodic and routine reactive works, compare road conditions with maintenance standards to determine treatment options; for routine cyclic works, apply standards to determine treatment frequencies (see Section 6).	Compare road conditions with design standards for renewal and periodic works (other works not normally designed) to determine design options.	Identify options for carrying out work by contract or with in-house resources, with equipment or labour-based methods, and for different specifications.	Determine detailed options for undertaking the remedial works.
4 Choose actions.	Choose the most appropriate treatments from the options available to address needs; this will require consideration of costs and priorities to produce a work programme within the budget (see Section 7).	Cost rates applied to design options to determine which design is most appropriate.	Select the most appropriate options from the above using pre-agreed criteria.	Choose the most appropriate action from the available options and then apply a 'performance standard' to determine performance targets, and labour, equipment and material resource requirements.
5 Implement.	Submit works programme for approval.	Undertake design, produce drawings, etc.	Prepare and let contracts or issue work instructions.	Undertake and supervise work.
6 Monitor and audit (see Section 9).	<ul style="list-style-type: none"> <li>Review programme produced prior to start of next programming cycle.</li> <li>Review programming procedures.</li> </ul>	<ul style="list-style-type: none"> <li>Review or check design.</li> <li>Review design procedures.</li> </ul>	<ul style="list-style-type: none"> <li>Review contract or work instruction.</li> <li>Review procurement procedures.</li> </ul>	<ul style="list-style-type: none"> <li>Review achievement against target.</li> <li>Review procedures for managing works activities.</li> </ul>
Length of cycle.	Typically one year.	Typically less than one year.		Typically days or weeks.

### 3 The role of the maintenance engineer

---

3.1 Roads are expensive to build. They repay their initial investment only by means of long-term care and maintenance. A road system that is well maintained brings important social and economic benefits:

- Roads have a longer lifetime of service because their surfaces do not deteriorate so rapidly.
- The transport links on which the economy and development depend are kept in good working order.
- Vehicle operating costs are reduced because traffic is able to run smoothly.
- Transport operations are safer and more reliable.
- Pollution and noise are reduced.
- Long-term network maintenance and renewal costs are reduced.

The maintenance engineer responsible for operations at regional or district level has a key role to play in achieving these benefits. Success depends largely on the way the task of management is approached.

3.2 In simple terms, maintenance management aims to get the *right* resources (people, materials and equipment), to the *right* place on the road network, to carry out the *right* maintenance or renewal work, at the *right* time. This task involves five main areas of responsibility:

- Assessing the need for works on the network (Chapter 5).
- Identifying maintenance and renewal treatments that can address needs (Chapter 6).
- Preparing the annual programme of works, arranging that funds are allocated fairly to the various parts of the road network, and deciding on priorities if the funds available do not allow the full programme to be undertaken (Chapter 7).
- Authorising and scheduling work, and making arrangements for it to be carried out effectively and efficiently (Chapter 8).
- Monitoring the quality and effectiveness of maintenance activities (Chapter 9).

These responsibilities underpin the sequence of maintenance management described in the relevant sections of this Note.

3.3 In performing the management role, maintenance engineers will, of course, have many hours of office work on network management and administrative matters. But it is essential that field visits are made as often as possible. Seeing things for themselves on site help to overcome many of the problems that can affect maintenance and renewal operations. There are several reasons why site visits are important:

- They enable the maintenance engineer to become thoroughly familiar with road conditions in the area, and so recognise trouble spots and other places where difficulties are likely to occur.
- First-hand knowledge can be gained of the extent and quality of the maintenance that has actually been carried out, instead of having to rely on reports from others.
- This knowledge can be used to assess maintenance priorities with much more confidence.
- Presence of the maintenance engineer on the spot means that advice can be given on problems as they arise.

- Seeing the maintenance engineer regularly on site boosts the morale of road gangs and so improves their standard of work and output; site visits are the most effective way of demonstrating commitment of the maintenance engineer to getting the job done successfully.

3.4 Maintenance engineers need detailed knowledge of all maintenance activities, but should delegate work to more junior engineers, technicians and foremen wherever possible. The time and skills of the maintenance engineer are best utilised by concentrating on programming (including budgeting) and the monitoring of maintenance operations. Procurement can be undertaken by either engineering or administrative staff. Design can be carried out by junior engineers or by consultants working under contract. The supervision of the majority of maintenance works ('operations management') should be delegated to a foreman or technician. The maintenance engineer's knowledge of road conditions provides the basis of decisions on which operations need personal supervision and which operations can be safely delegated to other staff. Only where there are problems requiring complicated treatment and on-the-spot judgement should the maintenance engineer become personally involved in managing site operations. The key point is to avoid the maintenance engineer's time being taken up by simple operations that less qualified staff are able to manage.

3.5 Delegation will only succeed if staff have the knowledge and competence to fulfil the duties they are given. Although outside the scope of this document, training is an important part of the responsibilities of the maintenance engineer. Important points to consider are:

- All members of staff should have appropriate training.
- Training should be built into the work programme and include practical on-the-job experience as well as more formal courses.
- Training should be an on-going feature of employment in the maintenance organisation, so that competent staff are available to take over when more experienced personnel are promoted, transferred to other duties, or leave.

For more details on training see Road engineering for development (Robinson and Thagesen 2004).

3.6 Effective maintenance management requires appropriate information to support management decisions, and the quantitative basis for this is provided through data. The processing of data is facilitated by the use of computer-based systems, and these are increasingly being used in all countries for maintenance management. A growing range of specialised software is available to help process data and analyse problems. The application of computers to maintenance management is a subject where staff training may be particularly useful. Computers can save time, as well as freeing the maintenance engineer for inspection and monitoring on site. But expenditure on computers can prove an expensive mistake if the system is not chosen with care and if suitable personnel are not available to make the best use of it. Maintenance can be managed efficiently without a computer, and Chapter 10 of this Note provides some guidance on how this can be done.

3.7 For most organisations, the management approach recommended in this Note will take some time to implement – perhaps a period of several years. The maintenance engineer should not try to put everything into practice at once. It is better to introduce new methods and procedures gradually, starting with straightforward measures that will produce early and positive results. Proceed step-by-step, and wait until one stage is working reasonably well before moving to the next. Concentrate first on the sections of road that carry the largest volumes of traffic and ensure these are adequately maintained before dealing with less busy roads.

## 4 Network information

---

### Information needs

4.1 Each step in the management cycle requires access to information to enable the step to be undertaken. Information is central to the road maintenance management. Basic information about the length and characteristics of the roads to be managed is obviously essential. However, in addition, information is needed about the ‘importance’ of individual roads and the traffic levels on them. Roads are normally classified according to their ‘importance’.

### Classification

4.2 Classification is the process by which roads are grouped into a hierarchy of classes, or systems, according to the character of service they are intended to provide. Basic to this process is the recognition that individual roads do not serve travel independently, but that most travel involves movement through an inter-connected network of roads. Road classification aids the channelisation of travel within the network in a logical and efficient manner. Roads within each class are expected broadly to provide a similar level of service. Thus, roads of each class are subject to common objectives, standards and intervention levels (see Chapter 6), and these may differ for roads of different classes. The road classification should therefore be designated as part of the policy framework. It is appropriate for the maintenance engineer to adopt a suitable road classification for maintenance purposes, if one does not already exist.

4.3 Table 4.1 gives examples of how road networks can be broken down into different classes, depending on the nature of the classification. Thus, a network classified ‘functionally’ could have the following components:

- *Arterial roads* – the main routes connecting national and international centres, with relatively high levels of traffic, speeds and average trip length.
- *Collector roads* – roads linking rural areas to adjacent urban centres or to the arterial network, with traffic flows and trip lengths of an intermediate level.
- *Access roads* – the lowest level of road in the network, with low vehicle flows and short trip lengths, and with substantial proportions of total movements likely to be by non-motorised traffic and pedestrians.

### Network definition

4.4 Classification and standards relate to the geographic location of the different parts of the road network. Thus, a system of ‘network referencing’ is needed for road maintenance management. The network is usually broken down into a series of ‘links’ or ‘sections’. ‘Links’ are lengths of road where traffic volume is reasonably uniform; ‘sections’ are lengths of road that are uniform in terms of their physical characteristics. Sections are normally the basic unit of a road network used for management purposes, but these are often sub-divided into ‘sub-sections’ for detailed analysis of road condition. The start and end of road sections are sometimes called ‘nodes’. The maintenance engineer should reference the network. Sections should be selected to have homogeneous characteristics, with the following being typically uniform for a section:

- Road class.
- Traffic level (i.e. sections should not include any major junctions).
- Road geometry.
- Pavement construction type.
- Other administrative data considered appropriate, such as administrative boundaries, speed limits, etc.

**Table 4.1 Examples of different road classifications**

<i>Nature of classification</i>	<i>Classes</i>				
Network priority	Primary	Secondary		Tertiary	
Functional	Arterial or trunk	Collector or distributor		Access	
Type	Major (road has mainly an economic function)			Minor (road has mainly a social function)	
	Major rural or non-urban		Urban	Rural transport infrastructure	
Designation (ownership)	National	Provincial/ regional	Municipal (urban)	Local (rural) government	Community (undesignated)
<i>Typical characteristics</i>					
Physical characteristics	Two and more lanes paved	Two lanes paved or gravel		Single lane gravel or earth	Tracks, trails and paths
Traffic (vehicles/day)	>2000	50-2000		<50	<10
Journey function	Mobility			Access	
Trip length	Long			Short	
Percent of total network length	~20		~10	~30	~40

4.5 The maintenance engineer should produce a roads register, or ‘gazetteer’, consisting of a list of links or sections to define the road network. Each section should be given a unique label for identification purposes. The format of this label can reflect the class of road. An example extract from a roads register is shown in Box 4.1.

4.6 It is convenient if the start and finish of sections are identified physically on the road. Road-side marker posts can be used for this, and it is often convenient to place additional marker posts at kilometre intervals. Marker posts need to be constructed in a robust manner to ensure their permanence and to reduce the possibility of their being damaged or moved inadvertently. It is particularly helpful to inspection teams if marker posts display the section label.

4.7 Referencing a network is a surprisingly time-consuming activity if it is done in a systematic and unambiguous way. But good referencing is crucial, since it provides the locational basis for all subsequent road management activities.

**Box 4.1 Example of a roads register**

Legrave District    DATE: November 1, 2003

Section label	Length (m)	Node		Description
		Start	End	
B486/20	603	563424	572392	Bramingham Road from Derby Rd to Weltmore Road
B486/30	1,750	572392	572341	Bramingham Road from Weltmore Rd to Park Road
B488/10	1,023	514381	539409	Legrave Road from 50km/h limit to Weltmore Road
B488/20	491	539409	546424	Legrave Road from Weltmore Rd to district boundary
2U164/10	960	525394	535406	Parkman Crescent from liquor store to bakers
2U210/10	823	534353	522369	May Avenue from Merryn Road to West Street
2U245/10	1,166	539409	572392	Weltmore Road from Legrave Rd to Bramingham Road
2U257/10	437	564420	569409	Matthews Road from Bramingham Road
2U258/10	197	573404	566402	Hannah Road from Bramingham Road
2U259/10	2,264	571362	532340	Merryn Road from Bramingham Road
2U355/10	703	539360	554340	Margaret Road from Merryn Rd to Telford Road
2U1401/10	415	553399	546387	Bosmore Road from Weltmore Rd to Carisbrooke Road
2U1401/20	813	548384	527376	Carisbrooke Road from school to Limbury Path
2U1401/30	419	545389	536375	Icknield Road from Carisbrooke Road
2U1503/10	339	563365	551361	Larkhall Road from Merryn Road
2U1504/10	335	551348	562353	Kenilworth Road from Margaret Road
2U2101/10	266	527354	532363	Ludlow Road from May Avenue
2U2102/10	234	522357	515350	Balcombe Road from May Avenue
2U2103/10	246	518372	525366	West Street from health clinic to Limbury Path

**Item inventory*****Content and preparation***

4.8 The 'item inventory' is a set of information about the basic engineering characteristics of the road network. It defines the key features of each section of road. This information is an essential reference source for inspection and analysis. The content of the inventory should be directly relevant to maintenance management. When it is first drawn up, it should be as simple as possible and need contain information on the following items, for carriageway and shoulders only:

- Section length.
- Type of surface and construction.
- Cross-section width.

4.9 As the inventory is built up, further information can be added on all factors influencing the management activities needed to prepare the work programme (see Chapter 7). In addition, data about the distribution and engineering properties of soils will be useful in identifying possible sources of maintenance materials. The level of detail recorded in the inventory may depend on the road class. Inventory data is expensive to collect and keep up-to-date. Generally, the inventory should be as simple as possible and not be overloaded with unnecessary information. Information should only be collected when there is a clearly-defined need, the cost of which outweighs the cost of collection. Ultimately, a typical inventory could contain the following information:

- Sections: the length of each section in the network.
- Cross-section: the width of the carriageway and shoulders, with information on whether kerbs, footways or side drains are present.
- Pavement: the type, thickness and, if possible, the age of the pavement on the carriageway and on the shoulders.
- Alignment: the chainage of characteristic points in the alignment, such as the location of crossroads, culverts, bridges, and sharp curves; details of steep gradients and the radii of sharp curves may also be recorded.
- Structures: the type and dimensions of major bridges, culverts and retaining walls.
- Furniture: information on road signs, guard rails, lighting and other features.
- Soils: information about the soil type along the road (clay, sand, rock, etc.), and location of identified deposits of road materials.
- Rainfall, topography and runoff.
- Land use: such as town, village, woods, farmland.

### ***Recording***

4.10 Appendix B of this Note describes the field procedures used in setting up an inventory, including the organisation of teams and transport. The maintenance engineer can delegate the preparation and day-to-day supervision of the work to a senior technician who understands fully the procedures.

4.11 Inventory data may often be collected by driving slowly along the road and stopping for measurement of characteristic cross-sections. Chainages can be recorded on the car's trip-meter. Information on pavement and structures can be obtained by inspection. However, some testing may be necessary, depending on the application to which the inventory will be put. Horizontal curvature can be determined with a compass, or in relation to the turning angle of the car's steering wheel. Gradients can be measured by means of a simple fall meter.

### ***Updating***

4.12 Although the preparation of the inventory is a once-only activity, it is very important that it is kept up-to-date. Information on changes to the network, such as new surfacings and reconstruction works, need to be entered into the item inventory, otherwise its usefulness is reduced. Assessing maintenance needs is then made more difficult.

### ***Presentation***

4.13 There are a number of ways of presenting the information recorded in the inventory:

- List.
- Schematic maps.
- Strip maps.
- Card index systems.

4.14 Where computers are available, it is simple to store the inventory as a list in a spreadsheet or simple database. This approach simplifies subsequent data additions, updates, analysis and reporting on the information contained.

4.15 Figure 4.1 shows a typical schematic map. It is basically a road plan of the area marked to indicate traffic levels, categories of road surface and road widths. This kind of map is particularly helpful in giving an overview of the whole network, enabling the maintenance engineer to see at a glance how roads with differing features relate to each other.

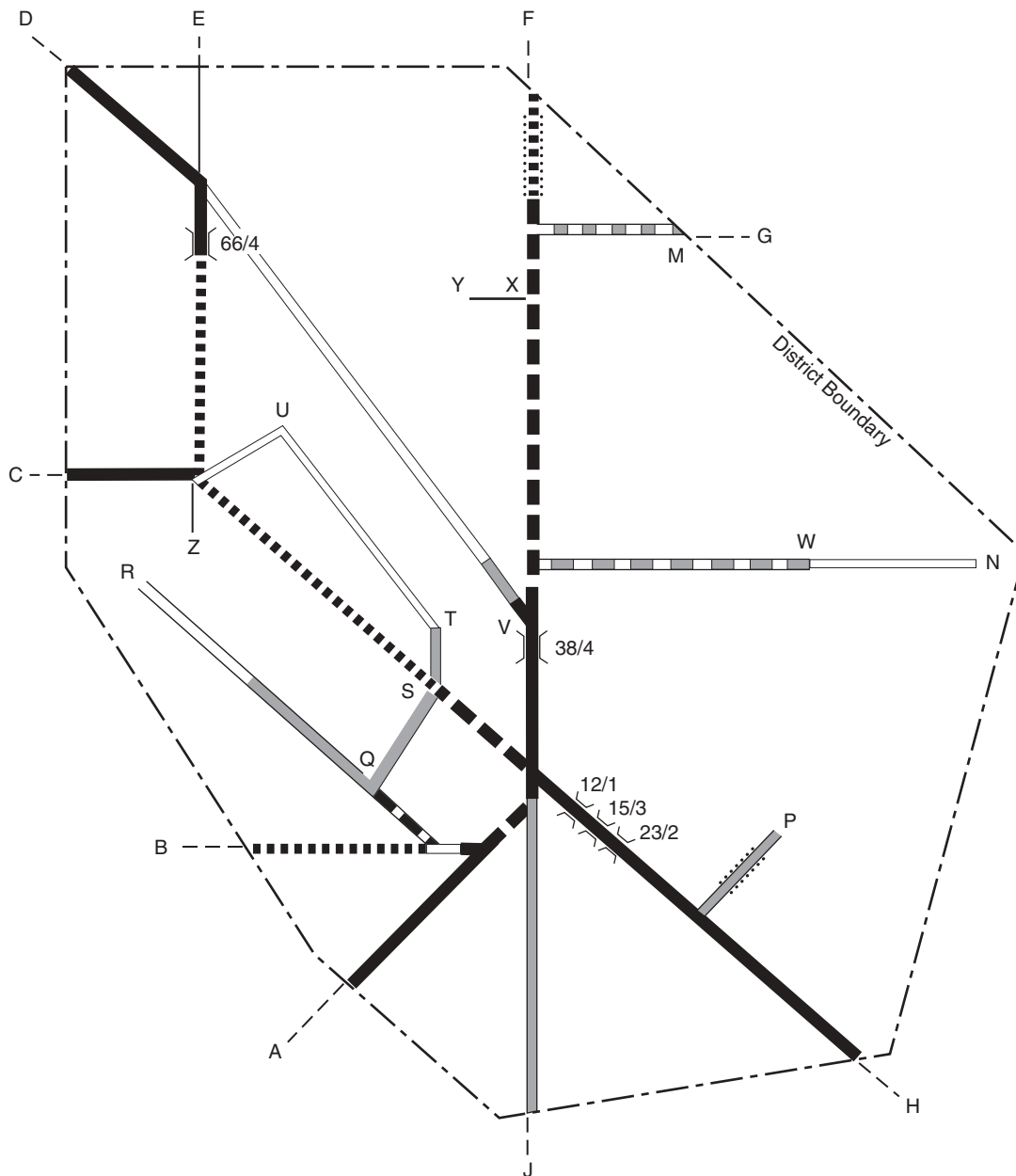
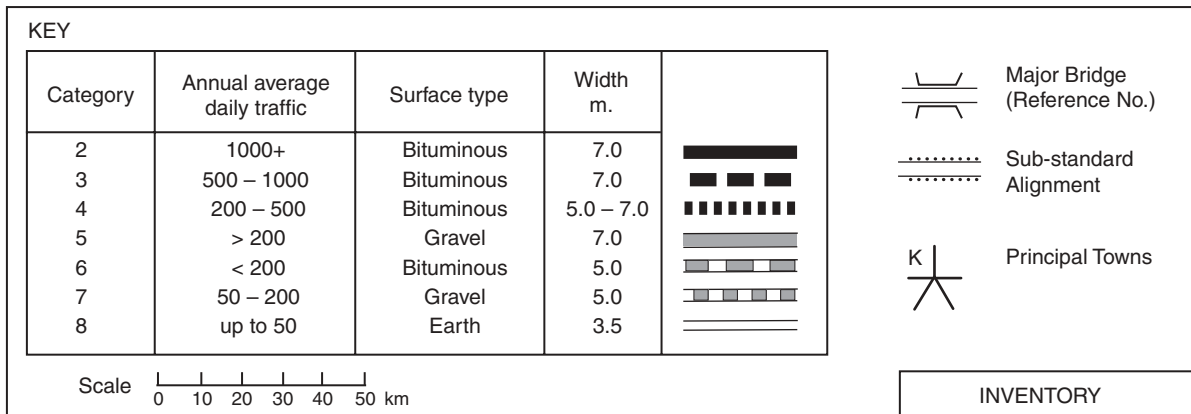

Figure 4.1 Example of a schematic map of a maintenance district

4.16 Figure 4.2 is an example of a strip map. This is a simple annotated drawing which records significant information about a section of road and its surroundings. Its principal use is in the field, where it provides a quick means of reference during inspections and surveys – especially for the location of chainage. It is often convenient to staple strip maps together to form a pocket-sized notebook for each road.

4.17 Card index systems are useful for registering details of items such as road structures and road signs. They can easily be updated when these items are repaired or replaced to provide a continuous record of their condition and maintenance history.

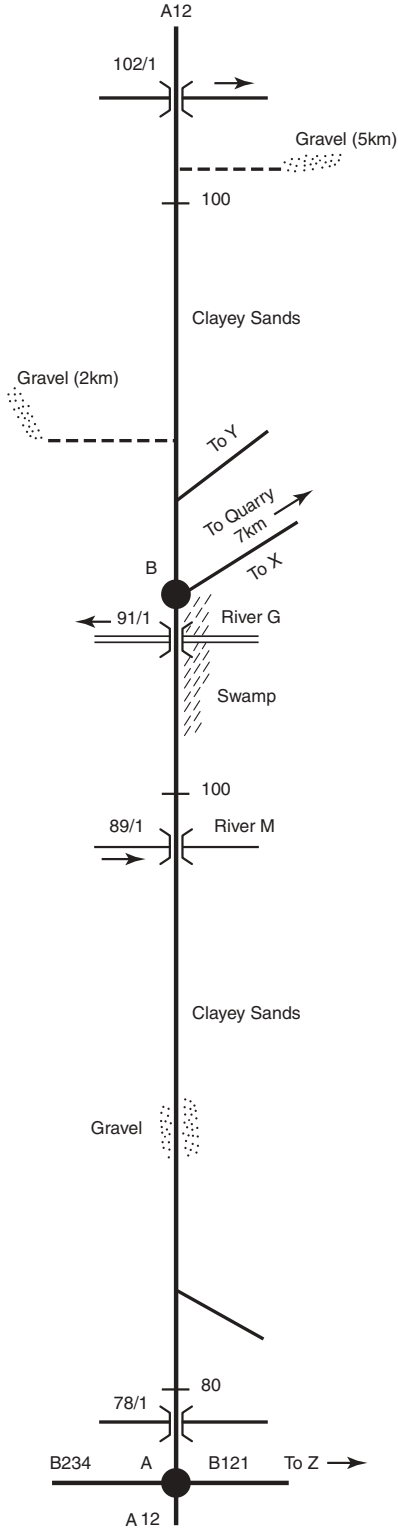

Figure 4.2 Example of strip map showing road inventory

## Traffic

4.18 The need for some maintenance activities will depend on the traffic volume and the distribution of axle loads on sections of the road network. Traffic volumes can be used to classify roads into broad categories for maintenance management purposes. A high level of accuracy is not required.

4.19 On roads carrying more than about 1000 vehicles per day, a one-day manual count will usually be sufficient to provide an estimate of the 'annual average daily traffic' (AADT) for the maintenance classification. Counts should be made every few years at selected counting stations. Traffic in intervening periods and future traffic can be estimated using growth factors. On roads with light traffic, it is normally sufficient to make a rough estimate of traffic using 'moving observer counts'. These involve measuring traffic whilst driving along the road. The maintenance engineer should habitually carry out moving observer counts when driving on all roads to provide regular checks on traffic levels. Methods of traffic counting and analysis are described in Appendix C.

4.20 The distribution of axle loads is needed to design some pavement renewal works. Measurements are normally made using portable weighing scales, as described in *Overseas Road Note 40* (TRL 2003). Measurements are normally made only in association with specific planned works. If the traffic volume is low, all passing vans, trucks and buses are weighed on an ordinary weekday. If the traffic volume is large, then a sample is normally taken. For example, every third passing commercial vehicle is stopped and weighed.

4.21 When the maintenance system is first applied, it will probably not be possible to include traffic counts as part of the maintenance planning process. Initially, traffic levels on the roads within the maintenance district may have to be estimated. But there is no substitute for counting vehicles. As the maintenance system develops, the traffic counting methods described in this Note should be introduced gradually into the management process.

## 5 Assessing needs

---

### Defects

5.1 Information is needed about where the network is defective to assess maintenance needs. The comparison between measured road condition and pre-defined standards, or intervention levels (see Chapter 6), provides a basic statement of shortfall in serviceability, which can be translated into maintenance need. It is convenient to characterise defects under the following headings:

- Paved roads:
  - roughness (unevenness);
  - surface distress (rutting, cracking, ravelling, pot-holes, etc.);
  - structural adequacy;
  - pavement texture and friction.
- Unpaved roads:
  - roughness, including corrugations;
  - surface distress (loss of camber, rutting, pot-holes, ravelling or loose material);
  - gravel loss;
  - dust.

5.2 Defects can be assessed using manual or mechanised methods. Visual inspections are normally used to record conspicuous defects of pavement, shoulders, side drains, culverts and road furniture. Mechanised data are more repeatable, reproducible and, generally, can be collected more efficiently. Their use is normally limited to the assessment of the need for pavement renewal works. Reference should be made to *Overseas Road Note 18* (TRL 1999) for descriptions of the following mechanised defect assessment methods for use in this context:

- Roughness.
- Structural adequacy:
  - deflection beam;
  - falling weight deflectometer (FWD).
- Pavement texture and friction:
  - sand patch test;
  - portable skid-resistance tester.

Mechanised methods of assessment are not discussed further in this Note, which concentrates on visual assessment of:

- Paved roads:
  - surface distress.
- Unpaved roads:
  - surface distress;
  - gravel loss.

5.3 Some defects deteriorate relatively rapidly, so it is not practical to assess the treatment needs for these on the basis of inspections. Examples are the roughness of gravel roads, ditch siltation, vegetation growth, etc. ‘Scheduled’ maintenance treatments are used to treat defects of this nature, and treatments can be carried out several times a year. This is discussed in Chapter 6. Scheduled treatments are also used for all routine cyclic works (see Table 2.1).

## Safety inspections

5.4 Safety inspections should be designed to identify all defects likely to create a danger or serious inconvenience to users of the network or the wider community. Such defects should include those of a serious nature at critical locations requiring urgent attention, and those where the nature and location are such that longer response times are more appropriate. The aim is to provide a practical and reasonable approach to managing the risks associated with road maintenance management. The inspection regime should take account of risk to all road users and, in particular, to pedestrians and non-motorised traffic, who are the most vulnerable.

5.5 Safety inspections are normally undertaken from a slow-moving vehicle at frequencies that reflect the characteristics of the particular road and its use. In heavily-used urban environments, particularly when inspecting footways, it may be necessary to walk these surveys. Additional inspections may be necessary in response to user or community concern, as a result of extreme weather conditions, or as a result of monitoring information (see Chapter 9).

5.6 Frequencies of safety inspections should be based upon consideration of:

- Road class.
- Traffic use, characteristics and trends.
- Incident and inspection history.
- Characteristics of adjoining network.
- Wider policy or operational considerations.

The frequencies shown in Table 5.1 can be taken as a starting point.

**Table 5.1 Safety inspection frequencies**

<i>Feature</i>	<i>Class</i>	<i>Frequency</i>
Pavements and shoulders.	Arterial.	Monthly.
	Collector.	3-monthly.
	Access.	12-monthly.
Footways.	Busy urban area.	Monthly.
	Other.	12-monthly.

5.7 During safety inspections, all observed defects that provide any degree of risk to users should be recorded, irrespective of the likely level of response. On-site judgement will always be needed to take account of particular circumstances. For example, the degree of risk from a pot-hole depends not just on its depth, but also on its surface area, its location and the traffic level using the road. Two categories of safety defect can be considered:

- Category 1 – those that require prompt attention because they represent an immediate or imminent hazard, or because there is a risk of short-term structural deterioration; examples are:
  - traffic accidents;
  - broken-down vehicles in the carriageway;
  - carriageway, shoulder or culvert wash-out;
  - collapsed culvert;
  - debris on the carriageway, etc.
- Category 2 – all other defects.

5.8 Category 1 defects should be corrected or made safe at the time of the inspection, if reasonably practicable. In this context, ‘making safe’ may constitute displaying warning signs, coning-off, or fencing-off to protect road users or the public from the defect. If it is not possible to correct or make safe at the time of the inspection, which will generally be the case, repairs of a permanent or temporary nature should be carried out as soon as possible and, in any case, within 24 hours. The aim should be to carry out permanent repairs within one month. Where temporary signing or works are used, arrangements should be made for a special inspection regime to ensure the integrity of the signing or repair until a permanent repair can be made.

5.9 Category 2 defects should be repaired within planned work schedules, with priority depending on the degree of defectiveness, traffic and site characteristics. These priorities should be considered when compiling the work schedule, together with access requirements, other works on the network, traffic levels and the need to minimise traffic disruption.

### **Network screening surveys**

5.10 In assessing the condition of the road, it is advisable to adopt a two-stage process of inspection:

- *Network screening survey* – in the first stage, an engineer or senior technician undertakes a drive-over survey of the network to identify those sections likely to need treatment.
- *Visual inspection* – the second stage involves a small team, led by a technician, whose task is to determine the requirements for reactive and periodic works, and to identify those sections where detailed investigations are needed prior to carrying out renewal works.

The advantages of this approach are that it provides a double-check on the state of the road network and the scale of maintenance requirements. It uses resources in a cost-effective way by directing them specifically to locations that call for skilled inspection and treatment.

5.11 The main purpose of the network screening survey is to identify the need for the more detailed visual inspections. For example, the survey can be used to screen-out those sections that are up-to-standard, enabling the visual inspections to concentrate on those sections that are likely to need treatment. The survey applies a serviceability ‘rating’ to pavements, shoulders, footways and side drains on a scale of ‘5’ (good) to ‘1’ poor. The survey and rating methods are described in Appendix B. The methods also record the likely remedial treatments that are needed for each section.

5.12 The results of the survey can be used to rank individual sections in terms of defectiveness. The maintenance engineer needs to review this to determine which sections are worth further investigation through a visual inspection. Clearly, road pavements ranked as ‘5’ (good) would not normally be investigated further, whereas those ranked as ‘1’ or ‘2’ would almost certainly be included in a visual inspection programme. The further inspection of roads ranked ‘3’ or ‘4’ would depend on the likelihood that they will need periodic or renewal treatments. The notes on likely treatment options recorded on the survey form will give guidance on this. The actual survey schedule produced will also depend heavily on the survey resources and time-scale available to the maintenance engineer for visual inspections.

5.13 It is possible to compare average ratings for the whole network year-on-year to see if overall conditions are improving, deteriorating or staying constant. Although this can provide useful information, the subjective nature of the surveys means that there could be significant errors attached to the results. Network screening surveys can be undertaken in conjunction with safety inspections – discussed earlier. This maximises the use of survey resources.

### **Visual inspections**

5.14 The maintenance engineer should aim to have the targeted parts of the road network inspected at least once a year, and should try to improve this frequency if at all practicable. The most appropriate time of the year for this will depend on the climatic conditions. The drainage system should ideally be inspected in wet conditions, since this can only be evaluated satisfactorily when there is water present. In regions where there are distinct wet and dry seasons, an inspection ought to be made in each part of the year. The wet season inspection will be particularly useful in

assessing the efficiency of drainage and in detecting cracking in bituminous surfaces, since this defect is more easily visible when the road surface is drying after rain. The network inspection will need to be completed in time for its results to be fed into the preparation of the budget estimate. Since most organisations prepare their estimates in the second half of the financial year, the maintenance engineer has to make sure that the inspection programme is undertaken before this.

5.15 The day-to-day supervision of inspection work can be delegated to trained technicians. But it is useful if the maintenance engineer participates personally in at least some of the visual inspections. This will ensure that maintenance works can be programmed effectively, based on personal familiarity with the road network. It also enables the quality of the inspections to be monitored.

5.16 Normally when inspecting a road section, the road is divided into subsections, typically 100 or 200 metres in length. The marker posts related to the roads register can be used as a reference, if they are present. An appropriate inspection method is described in Appendix B, which makes use of standard forms.

5.17 Pre-printed forms are especially useful in providing a check-list that tells the inspector what items are to be examined, and so reduces the possibility that significant data may be omitted. The inspection method and forms shown in the appendix are intended only as a guide. In some cases, the maintenance engineer will have to adopt a standard procedure and receive an issue of standard forms from his organisation. In other cases, it may prove more useful to develop a specific inspection procedure and to draw up forms designed to suit the particular road conditions in the locality.

5.18 Whatever form is used, it should be easy to understand and to complete. The road inspector should fill in the results on site, recording them accurately and legibly. The forms should then be retained in the office to provide a permanent record of inspection results. There is no need to make new, clean copies of forms completed on site: this wastes time and involves the risk of errors when information is transcribed.

5.19 It may be useful to summarise key results in the form of statistical tables or diagrams – for example, graphs that show rates of deterioration over time.

## 6 Determining options

---

### Basis of approach

6.1 Determining options for action involves selecting possible treatments that can be used to cure defects and to restore conditions to the required level. In dealing with defects, the maintenance engineer must interpret the inspection results (Chapter 5) to decide when and where repairs are needed, and what form of maintenance activity is required. Like a doctor treating an illness, the engineer has to recognise the symptoms that indicate it is time to take remedial action. Rules should be set up to identify the stage or circumstance at which the maintenance engineer should intervene, and the action to be taken to stop further deterioration. The use of pre-defined rules for treatment selection ensures that a consistent approach is taken to specifying works throughout the road administration. This helps to ensure that available funds are spent to greatest effect, and that each road and part of the network receives its fair share of the budget.

6.2 These rules are known as ‘standards’ and ‘intervention levels’. Ideally, they should be derived as part of the road maintenance policy framework. Standards and intervention levels provide the detailed operational targets to be worked to by individuals in the maintenance organisation. In some cases, they may be supported by legislation; in others, they will be determined by the road administration itself. Each objective in the road maintenance policy may be supported by one or more standards or intervention levels; standards and intervention levels should, in turn, support an objective.

6.3 The road maintenance engineer needs to identify a range of treatments that can be applied by the maintenance organisation to respond to road defects. These can be based on the treatment options considered by the Note, which are listed in Tables 6.1 and 6.2 for carriageways and off-road features respectively. These treatment activities are related to the groups, categories and treatment types given earlier in Table 2.1.

6.4 Two fundamentally different types of mechanisms are available for identifying when treatments are necessary:

- *Scheduled* – fixed amounts of work (such as a quantity in m<sup>2</sup>/km) are specified per unit time period (such as one year), or work is specified to be undertaken at fixed intervals of time; required maintenance activities are determined directly from applying the maintenance standard
- *Condition-responsive* – work is triggered when condition reaches a critical threshold (intervention level); required maintenance activities are identified as a result of field inspections to determine where intervention levels are exceeded

### Scheduled treatments

6.5 Scheduled treatments are used where need is related to environmental conditions, such as cutting back vegetation growth or cleaning culverts. The approach is also appropriate where the deterioration rate is stable over time. Also, where deterioration rates are rapid, such as for the surface of gravel roads, it is impracticable to respond to defects assessed as a result of condition surveys, so it is more convenient to schedule grading and dragging treatments. Routine cyclic maintenance works, by definition, are carried out on a scheduled basis.

6.6 The frequency at which cyclic works are carried out will depend on the requirements of the road maintenance policy, and will be influenced by level-of-service requirements and resources available for maintenance. In the absence of local standards, those listed in Table 6.3 can be used.

6.7 The requirements for grading on unpaved roads have to be determined independently of the results of network inspections. The maintenance engineer must decide how many times during the year each unpaved road will need grading to provide an appropriate level-of-service under local conditions. This assessment should take account of a range of factors including the type and size of the road material, the amount of traffic using the road, the local topography, climatic regime and other physical features. If the engineer has access to a computer, and has roughness measuring equipment available, the method outlined in Box 6.1 can be used to determine the optimum grading frequency for the road. If not, appropriate grading frequencies can be determined from Figure 6.1. In this figure, the solid line indicates the mean recommended frequency, which is the one that should normally be adopted. Grading the road more frequently than the mean will give road users a higher level of traffic-service: correspondingly, a grading frequency less than the mean will result in a lower level-of-service.

**Table 6.1 Maintenance and renewal treatments for carriageways**

<i>Group and category</i>	<i>Treatment type</i>	<i>Activities for different carriageway types</i>		
		<i>Asphalt-surfaced</i>	<i>Jointed-concrete</i>	<i>Unpaved</i>
<b>Maintenance</b>				
Routine planned.	Cyclic.			<ul style="list-style-type: none"> <li>• Grading.</li> <li>• Dragging.</li> </ul>
Routine unplanned	Reactive.	<ul style="list-style-type: none"> <li>• Patching.</li> <li>• Crack sealing.</li> <li>• Local sealing.</li> <li>• Edge repair.</li> </ul>	<ul style="list-style-type: none"> <li>• Patching.</li> <li>• Crack sealing.</li> <li>• Joint repair.</li> </ul>	
	Winter.	(Outside the scope of this Note).		
	Emergency.		<ul style="list-style-type: none"> <li>• Traffic accident removal.</li> <li>• Removal of broken-down vehicle.</li> <li>• Removal of landslide debris.</li> <li>• Removal of other debris on carriageway.</li> </ul>	
Periodic (planned).	Preventive.	<ul style="list-style-type: none"> <li>• Fog seal.</li> <li>• Slurry seal.</li> </ul>		
	Resurfacing.	<ul style="list-style-type: none"> <li>• Single surface dressing.</li> <li>• Otta seal.</li> <li>• Thin overlay.</li> </ul>		<ul style="list-style-type: none"> <li>• Regravelling.</li> </ul>
	Marking.		<ul style="list-style-type: none"> <li>• Renew line markings.</li> </ul>	
Renewal.	Overlay.	<ul style="list-style-type: none"> <li>• Structural overlay.</li> </ul>		
	Pavement reconstruction.	<ul style="list-style-type: none"> <li>• Mill and replace.</li> <li>• Inlay.</li> </ul>	<ul style="list-style-type: none"> <li>• Slab replacement.</li> </ul>	

**Table 6.2 Maintenance treatments for off-road features**

<i>Group and category</i>	<i>Treatment type</i>	<i>Activities for off-road features</i> <sup>1</sup>
<b>Maintenance</b>		
Routine planned.	Cyclic.	<ul style="list-style-type: none"> <li>• Grass cutting by machine.</li> <li>• Grass cutting by hand.</li> <li>• Machine cleaning of V-shaped side drains.</li> <li>• Machine cleaning of U-shaped side drains.</li> <li>• Manual cleaning of side drains.</li> <li>• Cleaning culverts.</li> <li>• Clearing bridge channels.</li> <li>• Sign cleaning.</li> <li>• Litter removal.</li> <li>• Sweeping.<sup>2</sup></li> </ul>
Routine unplanned.	Reactive.	<ul style="list-style-type: none"> <li>• Kerb repair or replacement.</li> <li>• Shoulder repair.</li> <li>• Footway repair.</li> <li>• Side drain repair.</li> <li>• Culvert repair.</li> <li>• Minor bridge repairs.</li> <li>• Sign repair or replacement.</li> <li>• Guard rail repair.</li> <li>• Retaining wall repair.</li> </ul>

<sup>1</sup> The maintenance and renewal of street lighting and other electrical apparatus are beyond the scope of this Note.

<sup>2</sup> Sweeping is carried out at the edge channel of asphalt and concrete carriageways where kerbs are present.

**Table 6.3 Routine cyclic works frequencies**

<i>Activity</i>	<i>Frequency (no. times per year)</i> <sup>1</sup>
Grass cutting by machine	2
Grass cutting by hand	2
Machine cleaning of V-shaped side drains	2
Machine cleaning of U-shaped side drains	2
Manual cleaning of side drains	2
Cleaning culverts	2
Clearing bridge channels	1
Sign cleaning	1
Litter removal	1
Sweeping	2

<sup>1</sup> Frequency can be increased for roads carrying high traffic levels, and reduced for low traffic levels.

### Box 6.1 Determining optimum grading frequencies

#### Basis of the approach

Ideally, an appropriate frequency of grading should be identified for each individual road. However, it is more practical to determine optimum grading frequencies for groups of roads with similar traffic levels, similar materials types and sizes, and sharing similar topographic and other physical features. The more often a road is graded, the smoother its surface will become and the less deterioration there will be between gradings. The end result will be lower vehicle operating costs on the road. The aim is to choose a frequency of grading which minimises the sum of maintenance costs and vehicle operating costs during the maintenance year.

#### HDM-4 analysis

The easiest way to determine vehicle operating costs for particular grading frequencies is to use a road investment model such as HDM-4 (PIARC 1999). The model should be used to carry out analysis for each selected road surface material type, climate, road geometry and traffic level. Vehicle operating costs are then determined for a range of grading frequencies. The results should be plotted in graph form. Curves such as those shown below should be obtained.

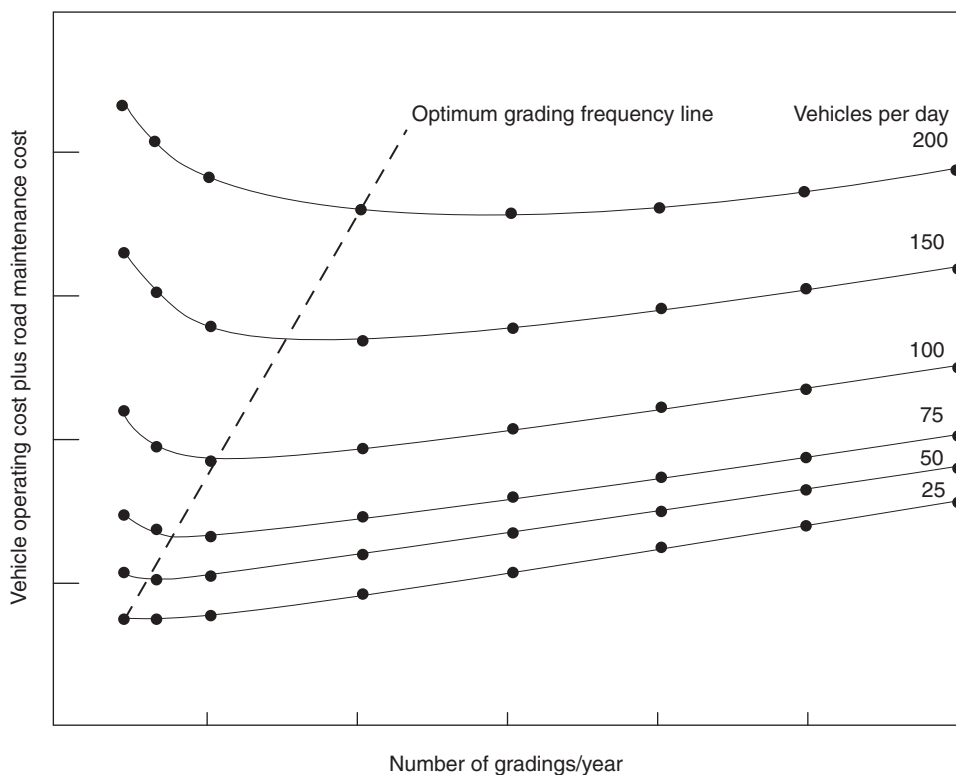

The minimum cost plotted at each traffic level will indicate the optimum grading frequency. The grading frequency should be applied to particular roads on the network by selecting the traffic level on the graph closest to that found in the field. Different optimum values will be obtained for different traffic levels, and for roads with different material types, with different road geometry, and in different climatic areas. It is necessary to undertake separate analyses for each of these cases.

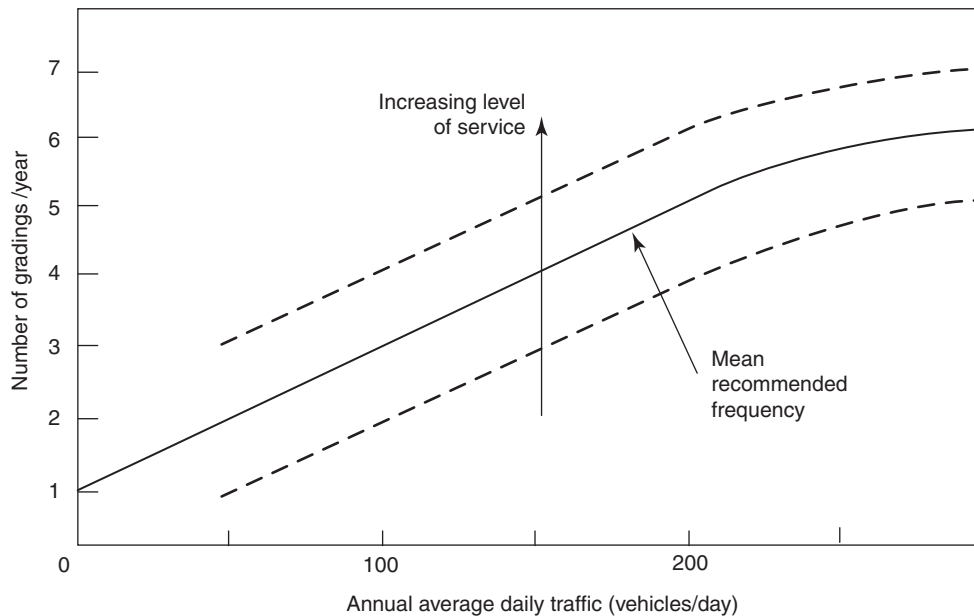

**Figure 6.1 Grading frequency chart**

*(Source: derived from studies carried out by TRL)*

6.8 Dragging needs to be done regularly where loose material lies on the road or where corrugations are liable to form. In the latter case, the operation may have to be repeated every few days. The maintenance engineer should determine the necessary frequency from a series of practical tests, by seeing how long it takes the corrugations to return after dragging is carried out. The frequency will vary for different materials, design of drag, traffic volumes and physical conditions.

6.9 The maintenance engineer should identify several roads that are representative of the network and arrange for a series of inspections to be performed immediately before the dates on which grading or dragging is scheduled. The inspection results will enable a check to be made on whether the frequencies of grading and dragging are appropriate. If, for example, a high degree of deterioration is still evident, the existing maintenance schedule should be adjusted to perform these activities more frequently.

### **Condition-responsive treatment selection for unpaved roads**

6.10 Regravelling is a periodic activity that will need to be performed whenever the existing layer of gravel becomes unacceptably thin. If this layer is found to be less than 50mm thick for more than 20 per cent of the length of the sub-section of road being inspected (Table 6.4), regravelling should take place. Appendix B includes advice on the inspection procedure.

6.11 Dust control is normally undertaken by the application of one of the following liquids to the road surface:

- Water.
- Deliquescent salts, such as calcium chloride.
- Organic compounds, including sulphite liquor, molasses, palm and other vegetable oils.
- Mineral oils, such as waste fuel oils.

The relief obtained by spraying roads with water is normally very short-lived, particularly in hot climates. Deliquescent salts function by retaining moisture in the surfacing. Organic compounds and mineral oils function by coating and binding the dust particles. Use of such dust palliatives is only economic when they are available as waste materials and, in all cases, their effectiveness is only temporary. When the cost of repeated applications is taken into account, the application of the above liquids is likely to be more expensive than a more permanent treatment, such as surface dressing. They may, however, be a useful expedient whilst awaiting more permanent action.

**Table 6.4 Maintenance intervention levels for unpaved roads**

<i>Defect</i>	<i>Level</i>	<i>Extent (per cent of sub-section length)</i>	<i>Action</i>	<i>Notes</i>
Gravel thickness	<50mm	>20	Regravel	
<ul style="list-style-type: none"> <li>• Roughness (including corrugations).</li> <li>• Surface distress (loss of camber, rutting, pot-holes, ravelling or loose material).</li> </ul>	See Paras 6.7-6.8.		Grading.	Scheduled (cyclic).
Dust.	–	–	See Para 6.11.	

### Condition-responsive treatment selection for paved roads

6.12 Treatments are triggered, in most condition-responsive methods, whenever one or more defects exceed their respective intervention level. Most methods require that the severity and extent of defects are determined. Ideally, intervention levels should be derived as part of the road maintenance policy framework, and will be influenced by level-of-service requirements, engineering issues and resources available for maintenance. Different sets of rules may be needed for roads of different classes, recognising the dependency on the level-of-service expected from a particular road.

6.13 It is advisable always to adopt intervention levels suited to the particular local situation. A wide range of intervention levels could be adopted appropriate to local construction and maintenance standards, and to environmental conditions. In the absence of local standards, use can be made of the intervention levels listed in Tables 6.5 to 6.7 for asphalt-surfaced pavements, jointed-concrete pavements, and off-road features, respectively. The recommended levels are based on the assumption that the road network is already being maintained to an adequate standard, and that sufficient resources are available to keep up this standard. In other words, they represent a target that the maintenance engineer should aim eventually to achieve. In those cases where there are too few resources available to apply the recommendations, alternative levels should be adopted that are more appropriate to the workload and local capabilities.

6.14 Some of the intervention levels in these tables are expressed in quantitative terms and require measurements to be made, as explained in Appendix B. Others involve simply a visual assessment. While the management system is being introduced, it is likely that the maintenance engineer will have to rely mainly on the visual assessment of defects, but measurement techniques should be introduced as skills and resources permit.

### Diagnosing the cause of deterioration

6.15 It is important to identify the cause of deterioration and to put this right if possible, rather than just treating the symptom. For example, there is little point in continually filling pot-holes in a road if they keep occurring because of poor drainage. Finding the real problem and focusing attention on its solution will produce a more cost-effective use of maintenance resources. It is therefore important that proper diagnosis of problems is undertaken by the maintenance engineer, and *Overseas Road Note 18* (TRL 1999) is a useful aid to this.

6.16 Some problems, of course, may be outside the scope of maintenance. For example, a road across flat country with inadequate drainage outfalls may experience base failure as a result of the capillary rise of water in the wet season. The only solution to the problem is to raise the level of the road. This would be a road improvement, not a maintenance operation. As such, it may warrant a special allocation of resources in accordance with the organisation's procedures for road improvement work.

**Table 6.5 Maintenance intervention levels for asphalt-surfaced pavements**

<i>Defect</i>	<i>Level</i>	<i>Extent (% of sub-section length)</i>	<i>Climate/ traffic category</i>	<i>Defect</i>	<i>Extent (% of sub-section length)</i>	<i>Action</i>	<i>Notes</i>
Ravelling.	Any.	<10	All.	–	–	Local sealing.	A fog spray of emulsion may be sufficient to renew the surface.
		>20	All.	–	–	Surface dress.	
Fatting-up or bleeding.	–	–	All.	–	–	No action.	Local sealing or surface dressing may be required if the lack of skid resistance is a problem. In this case, the excess binder must be burned off first. Sanding is appropriate when live (shiny) bitumen is on the surface.
Shoving.	Major.	Any.	–	–	–	Further investigation.	–
Pot-holes.	Any.	–	All.	–	–	Patch.	Extensive pot-holing may result from lack of effective maintenance or rapid deterioration of the road structure or surfacing. The cause must be determined and appropriate action taken.
Trench/ utility opening.	Poor reinstatement.	–	All.	–	–	Reinstate.	Cost of work should be charged to utility company.
Edge damage.	Erosion from original edge >150mm.	>20	All.	–	–	Patch road edge and repair shoulder.	If the failure is severe or persists, reconstruct the shoulder.
Edge step.	>50mm	>50	All.	–	–	Reconstruct shoulder.	–
Worn road markings.	Visual assessment (engineering judgement).	–	–	–	–	Renew markings.	–

*Continued ....*

Table 6.5 (Continued) Maintenance intervention levels for asphalt-surfaced pavements

<i>Defect</i>	<i>Level</i>	<i>Extent (% of sub-section length)</i>	<i>Climate/ traffic category</i>	<i>Defect</i>	<i>Extent (% of sub-section length)</i>	<i>Action</i>	<i>Notes</i>			
Wheel track rutting (surface dressing on granular base).	<10mm	–	Rainfall > 1500mm/yr OR Traffic > 1000vpd	Wheel track cracking.	<5	Seal cracks.				
					>5	Surface dress.	Single seals are often insufficient			
				Non-wheel track cracking.	<10	Seal cracks.				
					>10	Surface dress.	See note above.			
					Rainfall <1500mm/yr AND Traffic <1000vpd	Wheel track cracking.	<10	Seal cracks.		
				>10		Surface dress.	See note above.			
						Non-wheel track cracking.	<20	None.		
				>20		Surface dress.	See note above.			
				10-15mm	>10	All.	Any cracking.	–	Treat cracks depending on extent as above.	If rate of change of rut depth is slow.
									Further investigation.	If rate of change of rut depth is fast.
	>15mm	<10	All.	Cracking only associated with local ruts.	–	Patch.				
Other cracking.				–	Patch excess rutting and treat cracks depending on extent as above.					
				>10	All.	Any cracking.	–	Further investigation.		

Continued ....

**Table 6.5 (Continued) Maintenance intervention levels for asphalt-surfaced pavements**

<i>Defect</i>	<i>Level</i>	<i>Extent (% of sub-section length)</i>	<i>Climate/traffic category</i>	<i>Defect</i>	<i>Extent (% of sub-section length)</i>	<i>Action</i>	<i>Notes</i>					
Wheel track rutting (asphaltic concrete on granular base).	<10mm	–	Rainfall >1500mm/yr OR Traffic >1000vpd	Any cracking.	<5	Seal cracks.	Single seals are often insufficient for wide cracks.					
					5-10	Surface dress.						
					>10	Further investigation.						
					<10	Seal cracks.						
	>10mm	<5	All.	Cracking only associated with local ruts.	–	Patch.	Patch excess rutting and treat cracks depending on extent as above.					
						Other cracking.						
						>5		All.	Any cracking.	–	Treat cracks depending on extent as above.	If rate of change of rut depth is slow.
						Further investigation.		If rate of change of rut depth is fast.				

*Continued ....*

Table 6.5 (Continued) Maintenance intervention levels for asphalt-surfaced pavements

<i>Defect</i>	<i>Level</i>	<i>Extent (% of sub-section length)</i>	<i>Climate/ traffic category</i>	<i>Defect</i>	<i>Extent (% of sub-section length)</i>	<i>Action</i>	<i>Notes</i>
Wheel track rutting (asphaltic concrete or surface dressing on stabilised road base).	<5mm	–	Rainfall >1500mm/yr OR Traffic >1000vpd	Any cracking.	<10	Seal cracks.	Includes reflection.
					>10	Seal cracks and surface dress.	
					<20	Seal cracks.	
	5-10mm	>10	All.	Any cracking.	–	Treat cracks depending on extent as above.	If rate of change of rut depth is slow.
						Further investigation.	If rate of change of rut depth is fast.
>10mm	<5	All.	Cracking only associated with local ruts.	–	Patch.		
					Patch excess rutting and treat cracks depending on extent as above.		
	>5	All.	Any cracking.	–	Further investigation.		

*'Further investigation' should be undertaken using the method described in Overseas Road Note 18 (TRL 1999)*

**Table 6.6 Maintenance intervention levels for jointed-concrete pavements**

<i>Defect</i>	<i>Level</i>	<i>Extent</i>	<i>Action</i>	<i>Notes</i>
Cracking of slab.	Individual cracks wide enough to insert a coin.	Cracking in one or more directions, including corner cracks.	Concrete crack sealing.	Cracking not associated with local depressions.
	Inter-connected cracking associated with local depressions.	<50% of slab affected and/or loss of material from surface of slab, leaving coarse aggregate proud of the matrix, or causing loss of coarse aggregate.	Concrete patching.	
Loss of material from joint or arris.	Extending more than 100mm from the joint.	Extending more than 300mm along the joint.	Concrete joint repair.	
Steps at joints.	>25mm	–	Concrete slab replacement.	
Local depressions.	–	>50% of slab affected.		
Worn road markings.	Visual assessment (engineering judgement).		Renew markings.	

**Table 6.7 Maintenance intervention levels for off-road features**

<i>Feature</i>	<i>Defect</i>	<i>Level/extent</i>	<i>Action</i>	<i>Notes</i>
Kerb.	Missing or damaged.	Visual assessment (engineering judgement).	Kerb repair or replacement.	
Verge.	High vegetation.	Interferes with line of sight.	Grass cutting. <sup>1</sup>	
Shoulder.	Deformation or scour.	Hazardous to traffic, or endangering the structure of the road (engineering judgement) Extent >20% sub-section.	Shoulder repair (fill/patch).	
		Extent >50% sub-section.	Reconstruct shoulder.	
Footway.	Cracking or settlement.	Sudden trips >25mm.	Footway repair.	
Side drains.	Silted.	Ditch depth reduced to <1m or blocked to the extent that the free flow of water is impeded.	Clean side drains. <sup>1</sup>	Drainage faults should be corrected before the wet season starts.
	Standing water after rain.	Visual assessment (engineering judgement).	Side drain repair (realign to correct gradient).	
	Scoured or damaged.	Visual assessment (engineering judgement).	Side drain repair (build check-dams and fill).	Scour can develop rapidly, and can cause severe damage to structures; repair is urgent.
Culvert, including invert and outfall.	Silted.	Blocked to the extent that the free flow of water is impeded.	Clean culvert. <sup>1</sup>	
	Scoured or damaged.	Visual assessment (engineering judgement).	Culvert repair.	
Road sign.	Dirty.	Unreadable.	Sign cleaning. <sup>1</sup>	Includes road markings, warning and information signs, bollards, marker posts, etc.
	Damaged or corroded.	Visual assessment (engineering judgement).	Sign repair.	
	Missing.	–	Sign replacement.	

*Continued ....*

**Table 6.7 (Continued) Maintenance intervention levels for off-road features**

<i>Feature</i>	<i>Defect</i>	<i>Level/extent</i>	<i>Action</i>	<i>Notes</i>
Guard rail.	Damaged or missing.	Hazard to traffic, or failing to perform proper function.	Guard rail repair.	
Retaining wall.	Damaged.	Hazard to traffic, or the structure is in danger of collapse.	Retaining wall repair.	
Bridges and other structures. <sup>2</sup>	Silted or blocked.	Visual assessment (engineering judgement).	Clean out channel.	Drainage faults should be corrected before the wet season starts.
	Scoured.	Visual assessment (engineering judgement).	Repair (build scour control works and fill).	Scour can develop rapidly, and can cause severe damage to structures; repair is urgent.
	Structural damage.	Visual assessment (engineering judgement).	Repair.	

<sup>1</sup> Normally a cyclic activity, but action should be taken if inspections show that intervention levels are exceeded.

<sup>2</sup> Although the maintenance of bridges and structures is beyond the scope of this Note, they should be inspected at the same time as other road features, and the defects listed recorded for action; for the more serious defects, follow-up inspections should be undertaken using the procedures in Overseas Road Note 7 (TRRL 1988).

### **Specifying the work required**

6.17 The maintenance engineer should examine the completed inspection forms (Chapter 5) and compare the inspection results with intervention levels of the type recommended in Tables 6.5 to 6.7. The maintenance needs of each sub-section of the road network can then be determined, and the work required specified. The necessary action should be marked on the inspection forms, preferably in a different colour from that used for the survey results. The forms will provide a permanent record of maintenance requirements.

## 7 Choosing actions

---

### Selection from among options

7.1 The treatment selection process, described in Chapter 6, may indicate a number of different treatment options for an individual section of road. The options may each have a different cost, and a different treatment life. The process of choosing the appropriate action has to take account of the options available on each section of road, bearing in mind that there is unlikely to be sufficient budget to fund all of the treatments needed across the network. The process therefore involves the following steps:

- i Estimation of resource requirements, depending on the treatment and choice of work method.
- ii Costing these requirements.
- iii Grouping works into appropriate 'packages'.
- iv Prioritising works to determine which can be carried out within the available budget.

### Resource estimation

#### *Choice of work method*

7.2 The approach to estimating resources will depend on the work methods adopted for carrying out the physical road works. At this stage, therefore, choices have to be made between:

- Technology – whether labour or equipment-based methods will be used for different activities.
- Procurement method – whether activities are to be carried out by contract or using in-house labour resources.

There is some inter-relationship between these choices. For example: if procurement is to be by contract, then the choice of technology is a matter for the contractor to decide; however, the detailed procurement method may depend on whether the contract is to be let to a relatively large equipment-based contractor or to labour-based 'lengthworker' contractors. The methods of resource estimation will differ depending on whether work is to be undertaken by contract or using in-house staff.

#### *Choice of technology*

7.3 There are some activities that can only be done by manual labour; there are others where plant and machinery are essential; but many activities offer the option of either method. Trying to combine manual labour and machinery on the same activity will normally lead to inefficiency. The maintenance engineer may need to choose between a labour-based and an equipment-based method for each activity. In making this choice, account should be taken of the following factors:

- technological appropriateness;
- cost-effectiveness;
- availability of labour;
- availability of equipment;
- use of domestic resources.

7.4 Table 7.1 gives an assessment of the technological appropriateness of various maintenance activities for the use of labour-based and equipment-based methods.

7.5 It is likely to be more cost-effective to use labour-based methods where real labour costs are less than about US\$4-6 per day. At higher rates, equipment-based methods are likely to be more competitive. Where labour-based methods are cost-effective, the following should be noted:

**Table 7.1 Technological appropriateness for use of labour and equipment-based methods**

Activity	Potential for:	
	Labour	Equipment
<b>Routine cyclic</b>		
Grading (unpaved).	Impracticable.	Good – skilled. <sup>1,2</sup>
Dragging (unpaved).	Impracticable.	Good.
Grass cutting.	Good.	Good. <sup>3</sup>
Ditch cleaning and cutting.	Good. <sup>4</sup>	Good. <sup>4</sup>
Cleaning of culverts and bridges.	Good.	Poor.
Sign cleaning.	Good.	Impracticable.
Litter removal.	Good.	Fair.
Sweeping.	Good.	Good.
<b>Routine reactive</b>		
Patching (asphalt and concrete).	Good.	Poor.
Crack sealing (asphalt and concrete).	Good.	Poor.
Local sealing (asphalt).	Fair.	Poor.
Edge repair (asphalt).	Good.	Fair.
Joint repair (concrete).	Good.	Fair.
Kerb repair or replacement.	Good.	Fair.
Shoulder repair.	Good.	Fair.
Footway repair.	Good.	Fair.
Side drain repair, including building scour controls.	Good.	Poor.
Minor repairs to culverts and bridges.	Good.	Poor.
Sign repair or replacement.	Good.	Poor.
Manufacturing signs.	Good <sup>5</sup> – skilled. <sup>1</sup>	Fair. <sup>5</sup>
Guard rail repair.	Good.	Poor.
Retaining wall repair.	Good.	Poor.
<b>Periodic</b>		
Fog seal.	Fair.	Good – skilled. <sup>1</sup>
Slurry seal.	Fair – skilled. <sup>1</sup>	Good – skilled. <sup>1</sup>
Single surface dressing.	Fair – skilled. <sup>1</sup>	Good – skilled. <sup>1</sup>
Stockpiling chippings.	Poor.	Good.
Thin overlay.	Impracticable.	Good.
Regravelling including stockpiling gravel.	Fair.	Good.
Renew road line markings.	Fair.	Good.
<b>Renewal</b>		
Structural overlay (asphalt).	Impracticable.	Good – skilled. <sup>1</sup>
Mill and replace (asphalt).	Impracticable.	Good – skilled. <sup>1</sup>
Inlay (asphalt).	Impracticable.	Good – skilled. <sup>1</sup>
Slab replacement (concrete).	Good.	Good – skilled. <sup>1</sup>

<sup>1</sup> The expression 'skilled' implies that specific training of operatives is essential.

<sup>2</sup> Towed-graders can be substituted for motor graders for this activity, provided deterioration is not too great.

<sup>3</sup> The potential in this activity is dependent on the width of the shoulder and presence of obstructions such as road furniture and culvert headwalls.

<sup>4</sup> The potential in these activities is dependent upon suitable design of the ditch cross-section – 'V'-shaped ditches are suitable for maintenance by grader, whereas flat bottomed ditches are suitable for maintenance by hand or mechanical back-hoe.

<sup>5</sup> Some methods of manufacture may require the use of specialised plant (e.g. vacuum-application of reflective sheeting to sign plates).

- Tractor-trailer haulage is likely to be cost-effective for haul distances up to about 10km, and truck-based haulage should be used for distances greater than this.
- Labour-based surface patching operations on unpaved roads are only justified when traffic levels are below about 50 vehicles per day; above this traffic level, mechanical grading is necessary (possibly using towed-graders, which can be very cost-effective).

Note that, although machinery normally produces a truer surface and a more consistent finish than manual labour, this may not always be required. For example, it would be difficult to find any economic justification for giving low-volume roads the close tolerances of level and smoothness that machinery can achieve.

7.6 Labour-based methods are only appropriate where there is an abundant supply of labour available. The supply of labour is likely to be a problem where population density is less than about five persons per square kilometre. In addition to this demographic factor, labour availability is also affected by the availability of alternative employment; seasonal and climatic factors have an impact in some areas which might result in available labour being scarce: harvest times being an obvious example. There are also socio-cultural factors that result in labour not being available or willing to work on roads, even though it is relatively plentiful. Decisions must be taken on a district-by-district basis.

7.7 Many countries are faced with major problems over the availability of equipment, in particular the procurement of spare parts and the maintenance of mechanical equipment. This results in a low level of equipment availability that restricts the amount of road maintenance that can be carried out. Where there are difficulties keeping mechanical equipment operational, there is a strong case for using labour-based methods, wherever possible.

7.8 Simple equipment that is manufactured domestically should be easier to repair and keep operational than imported equipment. Tractor-based technology is likely to deliver higher equipment availability than the use of heavy equipment-intensive road maintenance. This approach is also less demanding on the use of imported resources, thus conserving foreign exchange.

7.9 The above considerations should be used to determine which choice of technology is the most appropriate for individual maintenance activities. Other factors may also have to be taken into account and, in some cases, the maintenance engineer may not be empowered to make this choice.

### ***Procurement by contract***

7.10 Traditionally, implementation of maintenance has been undertaken by the road administration itself. However, increasingly, work is procured under competitive contract arrangements to seek benefits in both effectiveness and efficiency. Under a contract system, the maintenance engineer enters into a formal agreement with a contractor for undertaking specific maintenance or renewal works. Normally the contractor should be chosen through competitive tendering from a number of bidders. Some different types of contracts are described in Chapter 8. If organisational policies permit, consideration should be given to undertaking maintenance and renewal works using competitive contracts.

7.11 For larger contracts for renewal or periodic maintenance, it is common for the maintenance engineer to appoint a firm of consulting engineers to assist in project administration and to supervise the work of the contractor. One advantage of a civil works contract is that responsibilities between the three parties – the ‘employer’ (the maintenance engineer), the ‘contractor’ and the ‘engineer’ (the consulting engineer) – are well-defined.

7.12 Contracting-out work can have the advantage of relieving pressure on the organisation’s labour resources and it can offer a high level of efficiency at a competitive cost. The detailed tender documents for these contracts need to include all details about the treatment design (see Chapter 8), so the method enables fair competition between potential contractors. The employer benefits by knowing the financial obligation before commencement of works. Drawbacks of works contracts are that procurement tends to be more time consuming than other project implementation methods because of the need for the detailed design to be substantially complete. The road administration will have to prepare detailed contract documents, set up a tendering procedure and provide contract supervision – all of which may require a substantial amount of time and effort on the part of its staff. There is also a risk that contractors bidding for maintenance work on a regular basis may

introduce 'price-fixing' to increase their profitability, and so involve the organisation in higher costs. On the other hand, time extensions, claims, and the like are safeguarded as a result of the detailed preparation. The maintenance engineer will have to weigh up these factors in relation to the capacities of his organisation and the performance of local contractors.

7.13 The activities in Table 7.2 should present no significant problems of administration or quality control if contracted out on the basis of competitive tenders. Specialist contractors can also be brought in to undertake the supply and maintenance of machinery and vehicles. The maintenance engineer should be satisfied that any contractor invited to tender for a job is capable of completing it satisfactorily, has the necessary personnel and equipment available, and is sufficiently knowledgeable about estimating procedures and current market rates to submit realistic prices.

**Table 7.2 Typical activities suitable for undertaking by contract**

---

**Maintenance and renewal activities**

---

***Routine cyclic***

Grading and dragging (unpaved).

Grass cutting and sweeping.

***Periodic***

Resealing: surface dressing, thin overlay, fog and slurry sealing (asphalt).

Renewal of road markings.

Regravelling (unpaved).

***Renewal***

Structural overlay, mill and replace, inlay (asphalt).

Slab replacement (concrete).

---

**Supply of materials**

---

Processed and natural gravels and aggregates.

Bitumen, cement and lime.

Precast concrete products.

Steel reinforcements.

---

***In-house works***

7.14 In-house implementation (also known as 'force account' or 'direct labour') is often used for road maintenance, but its use is less common for renewal works. As the design, works execution and supervision are handled by the road administration's own organisation, disagreement with other parties does not occur, and the personnel involved are familiar with the requirements, policies and procedures related to the works. It is often possible to save time by adopting an in-house approach because works can commence as soon as funding becomes available, even if this is before the design is complete.

7.15 A disadvantage is that government accounting procedures make it difficult to achieve adequate internal cost control, and this tends to result in higher overall works costs than for other execution methods. Quality control is also difficult to make effective. It can be difficult to hold anyone accountable for delays and poor quality works, given that the same organisation is both executing and supervising the works. There is often a reluctance to replace poor quality works because of the additional costs involved. Work is often implemented in a manner that makes maximum use of available resources (work force, equipment and materials), rather than applying rational and efficient work methods. This leads to inefficiency.

## ***Estimating***

7.16 The maintenance engineer should make an estimate of the likely cost of works, irrespective of whether this is to be carried out by contract or using in-house resources. This information is used as part of the programming and budgeting process. It is good practice to develop 'performance standards' for each works activity. An example is given in Box 7.1. A performance standard defines the materials, labour and equipment required for each works activity, and indicates the productivity and work accomplishment to be anticipated. They can be used to develop reliable unit rates for all activities to be undertaken. However, developing appropriate and reliable performance standards is a substantial task and relies on good information about works outputs being collected over a reasonable period of time.

7.17 It is normally relatively easy to estimate directly the quantities of materials needed for a works activity. Where the extent of the work can be defined precisely – for example, in the case of surface dressing or regravelling – quantities are determined in accordance with standard engineering practice. For other activities where requirements are less easy to define, such as edge repairs to bituminous surfaces, patching pot-holes and repairing defects in culverts, quantities are gauged on the basis of inspection results. The method can again follow standard practice, but these estimates will of necessity be less precise. The quantities determined should include an allowance for any emergency work that may be needed, for example in repairing storm damage to culverts or vehicle damage to bridge parapets.

7.18 The amounts of labour and equipment required will depend on the method used in carrying out the work. These also depend on the productivity levels anticipated from different maintenance activities. The productivity of an activity can vary considerable from country-to-country, but Table 7.3 can be used as a guide. It should be noted that the values in this table make no allowance for time that is not spent actually working, including non-productive time due to broken down or non-available equipment. Non-productive time can build up significantly during maintenance operations, and it should be an aim of management to reduce it to a minimum.

7.19 Table 7.3 indicates the outputs of work that can be expected from teams engaged on normal maintenance activities, using manual labour or machinery, as appropriate. Each output is expressed as a range: the amount of work that a team in fact achieves should lie within this range, depending on local conditions. For example, a labour-based approach to clearing side drains is likely to involve between four and ten workers using simple hand equipment, and the team can be expected to clear between 30 and 60 metres of drain per worker-day. A machinery-based approach to the same task will reduce the labour requirement to two or three labourers, using a grader and shovels and, as a team, they will be able to clear between four and seven kilometres per day. Many activities need only simple equipment, such as picks and shovels. The maintenance engineer should use this table as a guide to assessing the levels of productivity associated with various activities, and estimating the amount of labour required for each.

## **Costing**

7.20 Figure 7.1 shows how a standard form can be used to record the resources required for each activity and their estimated costs. A blank copy of the form is included in Appendix D.

7.21 The maintenance budget may include overheads allocated by the road administration to various activities other than actual maintenance operations. The maintenance engineer must take these sums into account when calculating the resources available for road works. The following items may be involved:

- Establishment – staff and buildings for managers.
- Road network management activities – strategic planning, programming, surveys, design and procurement, operations management.
- Administrative tasks – records, accounts and personnel management.
- Training.
- Emergencies – some funds may be set aside to cover the costs of reopening roads after emergencies or accidents.
- Technical assistance – e.g. advice to other organisations or local communities.

## Box 7.1 Sample output of a performance standard

OPERATIONS SYSTEM

PERFORMANCE STANDARD

Revision C: 01 April 1997

Page 1 of 1

WORKS ITEM CODE:

LG-112

DESCRIPTION: Single surface dressing

DEFINITION	Application of one coat of surface dressing consisting of a layer of bituminous binder on prepared surface covered by a layer of stone chippings
RESTORATION STANDARD	Uniform appearance with stone to stone contact
RELEVANT SPECIFICATION	LGS 11.22, LGS 11.34 - 11.37

UNIT OF MEASUREMENT	m <sup>2</sup>
AVERAGE DAILY PRODUCTION	2 000 m <sup>2</sup>

WORKS METHOD	
<ol style="list-style-type: none"> <li>1) Establish traffic control - refer to Roadworks Signing Guide</li> <li>2) Inspect pavement and mark out all areas of repairs if this has not already been done</li> <li>3) Repair potholes and edge damage (see LG-008 and LG-009)</li> <li>4) Remove all loose material with hand or mechanical brooms</li> <li>5) Confirm and check all plant is working before commencing surfacing operation</li> <li>6) Apply bitumen using distributor ensuring even spread (confirm rate of 1.0kg/m<sup>2</sup> with Supervisor)</li> <li>7) Spread aggregate uniformly (confirm rate of 14kg/m<sup>2</sup> with Supervisor)</li> <li>8) Roll to embed aggregate with 8-10 tonne rubber-tyred roller or other approved plant</li> <li>9) Brush to remove surplus aggregate using mechanical broom or manually</li> <li>10) Remove traffic control, leaving loose chipping warning signs if necessary</li> </ol>	

ESTIMATED ITEM COST				
LABOUR		NUMBER	RATE	AMOUNT
Foreman/Supervisor		1	195.00	195.00
Operator		5	150.00	750.00
Semi skilled labourer		2	135.00	270.00
Labourer		6	125.00	750.00
EQUIPMENT				
Bitumen distributor		1	375.00	375.00
Road roller (8/10t)		1	400.00	400.00
Loading shovel (1.5m <sup>2</sup> )		1	550.00	550.00
Tipper truck (5/10t)		1	410.00	410.00
Gritter		1	100.00	100.00
Signs and traffic control		1	50.00	50.00
Mechanical broom		1	200.00	200.00
MATERIALS		UNIT	QUANTITY	
10mm aggregate	tonne	28.0	25.50	714.00
MC3000 bitumen	kg	2000.0	0.24	480.00
Diesel	litre	25.0	0.91	22.75
TOTAL				5266.75
ESTIMATED UNIT RATE				2.63

**Table 7.3 Examples of work outputs from activities**

Activity	Resource requirements			Output unit	Range of outputs
	Personnel	Equipment	Materials		
Clearing side drains by hand.	4-10	Shovels, cutlasses, picks .	–	m/worker-day.	30-60
Clearing side drains by machine.	2-3	Grader, shovels.	–	km/day.	4-7
Re-excavating side drains.	2-10	Picks, shovels.	–	m/worker-day.	8-15
Clearing culverts.	2-4	Shovels, head-pans/ wheelbarrows.	–	no/worker-week.	2-4
Minor repairs to culverts.	2-4	Masons' tools.	Cement, aggregate, sand.	no/worker-week.	2-10
Major repairs to culverts.		To be assessed for each job.	–	worker-day.	–
Making culvert rings (1m diameter × 1m long).	4-10	Moulds, mixer, shovels.	Cement, stone, sand, reinforcement.	no/day.	5-10
Grading unpaved surfaces.	2	Grader, camber board, spirit level.	–	pass-km/day. <sup>1</sup>	20-50
Dragging unpaved surfaces.	1	Tractor and drag.	–	pass-km/day. <sup>1</sup>	20-50
Patching bituminous surfacings.	5-7	Pedestrian roller or hand rammers, brushes, picks, shovels, watering cans.	Premix or gravel, bitumen emulsion, chippings or washed gravel.	m <sup>3</sup> /worker-day.	0.5-0.8
Filling gravel surfaces.	5-7	Pedestrian roller or hand rammers, brushes, picks, shovels, watering cans.	Gravel.	m <sup>3</sup> /worker-day.	0.6-1.2
Filling earth surfaces and slopes.	4-5	Hand rammers, brushes, picks, shovels.	Selected earth.	m <sup>3</sup> /worker-day.	0.9-1.5
Grass cutting by hand.	2-10	Cutlasses.	–	m <sup>3</sup> /worker-day.	300-800

*Continued ....*

**Table 7.3 (Continued) Examples of work outputs from activities**

<i>Activity</i>	<i>Resource requirements</i>			<i>Output unit</i>	<i>Range of outputs</i>
	<i>Personnel</i>	<i>Equipment</i>	<i>Materials</i>		
Grass cutting by machine.	1-2	Tractor/mower.	–	km/day.	10-20
Repairing and replacing traffic signs.	2-3	Masons' tools, painters'.	Cement, stone, sand, tools, shovels.	no/worker-day paint, reflective paint.	4-8
Road markings.	2-4	–	Road paint.	m/worker-day.	50-200 (hand painting).
Stockpiling gravel by hand.	10-20	Picks, shovels.	–	m <sup>3</sup> /day.	450-500
Stockpiling gravel by machine.	4	Bulldozer, loader.	Gravel.	m <sup>3</sup> /day.	300-350
Regravelling gravel surfaces.	12-20	1 grader, 8 tippers, 1 loader, 1-2 water tankers, 1 roller	Gravel.	m <sup>3</sup> /day.	300-350
Surface dressing.	15-20 <sup>2</sup>	1 distributor, 1 roller, 3 tippers, 1 gritter, 1 loader.	Bitumen, chippings.	lane-km/day.	2.5-4.0

<sup>1</sup> 'Pass-km' is the actual distance the grader travels while working.

<sup>2</sup> + 10 additional if no loader is available + 10 additional if no gritter.

**Resource requirements and cost estimate**

District: <i>Central</i>					
Activity: <i>Regravelling</i>		Period: <i>Nov/Dec 2003</i>			
Section: <i>C231</i>		Budget: <i>Recurrent</i>			
Length: <i>25</i> km/ <del>metres</del>		Width: <i>6</i> metres			
Resource	Quantity	Unit	Rate	Cost	
<b>Labour</b>					
Supervisors <i>2 no.</i>	<i>120</i>	Worker-day	<i>7.80</i>	<i>936.00</i>	
Unskilled <i>8 no.</i>	<i>480</i>	Worker-day	<i>2.52</i>	<i>1209.60</i>	
Skilled 1 <i>Grader operator</i>	<i>60</i>	Worker-day	<i>5.12</i>	<i>307.20</i>	
2 <i>Roller operator</i>	<i>120</i>	Worker-day	<i>4.38</i>	<i>525.60</i>	
3 <i>Truck driver</i>	<i>60</i>	Worker-day	<i>4.12</i>	<i>247.20</i>	
4		Worker-day			
5		Worker-day			
6		Worker-day			
Sub-total				<i>3225.60</i>	
<b>Equipment</b>					
1 <i>Grader</i>	<i>500</i>	<i>hr.</i>	<i>25.00</i>	<i>12500</i>	
2 <i>6-8 tonne roller</i>	<i>1000</i>	<i>hr.</i>	<i>10.00</i>	<i>10000</i>	
3 <i>Dump truck</i>	<i>600</i>	<i>hr.</i>	<i>9.00</i>	<i>5400</i>	
4					
5					
6					
7					
8					
Sub-total				<i>6820</i>	
<b>Materials</b>					
1	<i>10000</i>	<i>m<sup>3</sup></i>	<i>200</i>	<i>20000</i>	
2					
3					
4					
5					
6					
7					
8					
Sub-total				<i>20000</i>	
Total				<i>29745.60</i>	

Signed ..... *Th. E. Engineer* .....

**Figure 7.1 Example of a resource requirements form**

7.22 Traditional engineering unit pricing techniques are normally applied to the resource estimates to develop the anticipated works costs for programming and budgeting purposes. Providing that resources have been estimated using the methods described above, then costing should be relatively straightforward. Expected values and timescales should reflect past experience of actual achievement on completed works with similar characteristics. However, there are difficulties associated with costing methods because there are many variables that affect works cost in different situations and circumstances. More details of cost-estimating techniques appropriate to road maintenance works can be found in *Road maintenance management: concepts and systems* (Robinson and others 1998). This describes issues of where and how cost data can be obtained, and the reliability of different cost-estimating methods.

7.23 Note that, at the ‘programming’ stage, it would be normal to use only unit rate costing methods applied to works ‘types’ (see Table 2.1). More detailed costing methods should be used at the works implementation stage, once a budget has been awarded.

### Works packaging

7.24 When works are to be undertaken by contract, there may be a minimum size of works for which the use of a contract is cost-effective. Also, where treatment lengths are relatively short, it may sometimes be more cost-effective to combine treatment lengths, even of a different treatment type, into contract packages. These same considerations apply even if works are to be undertaken in-house, if the most cost-effective implementation is to be achieved. Therefore, the way that works are packaged will affect their costs.

7.25 A simple method of contract packaging is described in Box 7.2. This uses decision rules to combine road lengths of uniform defectiveness into ‘treatment lengths’ on which it is cost-effective for works to be carried out. On any length of road, the aim is to group projects or schemes containing the same or compatible works on adjacent road lengths. This may involve applying more expensive treatments than would otherwise be justified on some sections of road. The process may be considered in terms of seeking economies of scale in terms of treatment cost.

#### Box 7.2 Example of approach to contract packaging

Consider the three sections of road A, B and C, shown below:

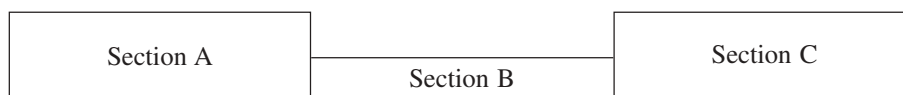

*Adjacent road sections requiring different treatments*

Sections A and C require an overlay at a fixed cost of \$F1, and a variable cost of \$V1 per unit area. Section B requires surface dressing at a fixed cost of \$F2, and a variable cost of \$V2 per unit area. Therefore, the cost of applying separate treatments to the three sections is:

$$(\$F1 + \$V1.\text{areaA}) + (\$F2 + \$V2.\text{areaB}) + (\$F1 + \$V1.\text{areaC})$$

However, if an overlay were to be applied throughout, then the cost would be:

$$\$F1 + \$V1(\text{areaA} + \text{areaB} + \text{areaC})$$

It follows that if

$$(\$F1 + \$F2)/(\$V1 - \$V2) \geq \text{areaB}$$

then it is economic to overlay all sections, rather than to overlay A and C, and to surface dress B.

7.26 Works should also be packaged into lots to suit contracting capability and capacity. Packaging should also be considered for works to be undertaken by in-house units. The size, content, start date and duration of each package depend on a number of factors:

- The size of packages can be chosen to provide a spread of work across contractors of different size and resource capabilities; for example, equipment-based and labour-based contractors.
- Separate packages may need to be prepared for routine, periodic and renewal works:
  - because funds come from different budgets;
  - to attract contractors of different size;
  - term-contracts are relatively simple to set up for routine works, whereas periodic and renewal works are undertaken as discrete projects.
- A variety of work in a particular location can be packaged together to reduce contract mobilisation costs.
- A small number of large packages is normally easier and cheaper to administer and manage than a large number of small contracts.

## **Priority assessment**

### ***Purpose***

7.27 It is likely that resources will be limited, and decisions will therefore be needed on the most effective way of applying them. This means working out an order or priority, with the operations that have the strongest claim on resources placed at the head of the list and those that have least claim placed at the end. This part of the Note gives an example method that will enable the maintenance engineer to identify priorities objectively and consistently. The method is straightforward: it simply relates the importance of the maintenance activity to the importance of the road. It asks two basic questions:

- How critical is a particular maintenance activity to the traffic performance of the road?
- How significant is the particular road as a transport link?

The maintenance engineer should review this method and make any adaptations to it that are necessary to meet particular local circumstances.

### ***Example method***

7.28 Maintenance activities may be ranked in the order of importance shown in Table 7.4.

7.29 The roads that carry the heaviest loads of traffic are normally the most important parts of the network from an economic standpoint. They are also the roads liable to deteriorate most rapidly from wear and tear. There may also be roads with relatively low levels of traffic, which nevertheless have key strategic importance because of the places they link, such as international airports, important government buildings, or key industrial facilities. Generally, there will be only one or two such roads in any district. Since it is vital to keep these strategically important roads in good condition, it makes sense to give them top priority for maintenance work.

7.30 The remainder of the network should be classified by the level of traffic on each road. This level is usually expressed in terms of the estimated annual average daily traffic (AADT); i.e. the total traffic in both directions during the year, divided by 365. Estimates are needed for traffic flow on every part of the network, including minor and unpaved roads. The estimate is most reliable if it is derived from actual traffic counts. However, it is only necessary for maintenance prioritisation purposes to group roads into traffic 'bands'. Simple traffic count procedures for this are described in Appendix C.

7.31 Table 7.5 sets out a simple hierarchy of roads by order of importance based on traffic level. It is meant as an example, which the maintenance engineer can adapt to reflect the character of his road network and the general levels of traffic.

**Table 7.4 Maintenance activities by order of importance**

<i>Hierarchy of maintenance category/type</i>	<i>Work activities</i>	<i>Notes</i>
1. Emergency work.	<ul style="list-style-type: none"> <li>• Emergency repairs to blocked or impassable roads.</li> <li>• Removal of traffic accidents, broken-down vehicles, landslide or other debris on the road.</li> </ul>	Emergency works of this type are where there is a danger-to-life. As such, they demand top priority. Past experience will indicate the scale of the resources that need to be set aside for these activities.
2. Routine drainage work.	<ul style="list-style-type: none"> <li>• Cleaning of side drains, culverts and bridge channels (cyclic).</li> <li>• Side drain or culvert repair; minor bridge repair (reactive).</li> </ul>	This work always deserves high priority because neglected drainage can rapidly lead to deterioration of the whole road, especially where defects affect the direct entry of water into the pavement. It should not be assumed that all drainage work must take precedence over all other work. The key point is that repairing surface defects caused by poor drainage will be a waste of time and effort unless the drainage is put right first.
3. Routine pavement work.	<ul style="list-style-type: none"> <li>• Patching, crack sealing, local sealing and edge repair (asphalt).</li> <li>• Patching, crack sealing and joint repair (concrete).</li> <li>• Grading and dragging (unpaved).</li> </ul>	The importance of this work reflects its impact on the structural integrity of the road and on traffic safety.
4. Periodic work.	<ul style="list-style-type: none"> <li>• Fog and slurry seal, surface dressing and thin overlay (asphalt).</li> <li>• Road line marking (asphalt and concrete).</li> <li>• Regravelling (unpaved).</li> </ul>	Periodic work can be treated as a series of distinct projects that have to compete for the resources available and can be undertaken separately, deferred or brought forward as required.
5. Other routine work.	<ul style="list-style-type: none"> <li>• Grass cutting, sign cleaning, litter removal, sweeping (cyclic).</li> <li>• Kerb repair or replacement, shoulder and footway repair, sign repair or replacement, guard rail and retaining wall repair (reactive).</li> </ul>	This work is mainly of an 'environmental' nature and is of relatively low priority.
6. Renewal work.	<ul style="list-style-type: none"> <li>• Structural overlay, mill and replace, and inlay (asphalt).</li> <li>• Slab replacement (concrete).</li> </ul>	Renewal work has high unit cost and has low priority to avoid swallowing-up large portions of the maintenance budget. Works can be treated as a series of distinct projects, as for periodic works (above).

**Table 7.5 Road traffic levels by order of importance**

<i>Importance</i>	<i>Traffic level (vehicles/day)</i>	<i>Surface type</i>
1	(Strategic roads)	–
2	Greater than 1000	Asphalt and concrete.
3	500 – 1000	Asphalt and concrete.
4	200 – 500	Asphalt and concrete.
5	Greater than 200	Unpaved.
6	Less than 200	Asphalt and concrete.
7	50 – 200	Unpaved.
8	Less than 50	Unpaved.

7.32 An axle-load survey, in addition to traffic counts, may be justified if the traffic composition on a particular road is believed to be significantly different from that on the network as a whole – for example, on a road that carries large numbers of heavy freight vehicles. The survey can be completed in a few days using a portable weighbridge. Guidance on procedures for axle-load surveys is included in *Overseas Road Note 40* (TRL 2003).

7.33 Table 7.6 is an *example* of a matrix that can be used to assign priority numbers to the various maintenance activities. The matrix is defined in terms of the hierarchies of maintenance activities and traffic from Tables 7.4 and 7.5. Maintenance activities are numbered from 1 (highest priority – emergency maintenance on strategic roads) to 48 (lowest priority – renewal works on unpaved roads with very low levels of traffic). The matrix is designed to ensure that every road in the network receives at least the minimum maintenance needed to keep it operational, while at the same time focusing routine pavement and periodic maintenance on the economically important roads with high traffic levels. As noted above, strategically important roads have absolute priority for resources, even where renewal works are concerned.

**Table 7.6 Example matrix of maintenance priorities**

<i>Hierarchy of maintenance activity</i>	<i>Traffic hierarchy</i>							
	<i>1</i>	<i>2</i>	<i>3</i>	<i>4</i>	<i>5</i>	<i>6</i>	<i>7</i>	<i>8</i>
1. Emergency	1	7	8	9	10	11	12	13
2. Routine drainage	2	14	15	16	17	18	19	20
3. Routine pavement	3	21	24	27	30	33	36	39
4. Periodic	4	22	25	28	31	34	37	40
5. Other routine	5	23	26	29	32	33	34	35
6. Renewal	6	42	43	44	45	46	47	48

7.34 The maintenance engineer should develop a matrix appropriate to local conditions. This can then provide a master list identifying, in order of priority, all the works that need to be done on the network. While the numbering scheme in Table 7.6 is a rational and consistent order of priority, it is not meant to be inflexible. There may well be local conditions of soil type, topography and climate that influence maintenance requirements on different parts of the network. These may warrant an amended order of priority. The type of local factors involved may include, for example, the presence of expansive clay subgrades, which are likely to cause maintenance problems, or the combination of steep slopes and high rainfall where run-off may accelerate the process of erosion. The maintenance engineer should feel free to reorder the list of priorities to suit local conditions, where necessary.

#### ***Alternative prioritisation methods***

7.35 Box 7.3 provides some notes on alternative methods that can be used to prioritise maintenance works.

### Box 7.3 Alternative prioritisation methods

An alternative method of prioritisation can be used that takes into account the cost-effectiveness. In this context, 'effectiveness' is the measure of the future 'worth' of the works that are undertaken. 'Cost' is the present-day cost of the works. Cost-effectiveness is, simply, the ratio of effectiveness to cost. The ratio can be used in the relative comparison of options. Future consequences of actions are only taken into account through the inclusion of the expected life of the treatment. Thus:

$$\text{Cost-effectiveness} = \frac{\text{Expected life in years of the treatment alternative}}{\text{Unit cost}}$$

Simple cost-effectiveness methods tend to give priority to the cheaper treatments, such as surface dressing, because these give good returns in terms of increased life per unit of cost, but the methods do not take account of consequential costs. Because of the impact of mobilisation costs, the size of works also affects the cost-effectiveness.

If computers are available, then more sophisticated prioritisation can also be used. These are described in *Road maintenance management: concepts and systems* (Robinson and others 1998).

### Determining the work programme

7.36 The next step is to compare the costs of the proposed maintenance and renewal works with the funds available. Budgeting procedures within the road administration may mean that the funds available for routine, periodic and renewal works are not interchangeable. If this is the case, then priorities need to be assigned separately for works to be undertaken within each budget head. There may also be a need, from an equity point of view, to assign at least a minimum budget level to each sub-district covered by the road administration. This also needs to be taken into account in the prioritisation.

7.37 The extent to which the maintenance engineer can influence how the available budget is spent will depend on the resource allocation procedures in his organisation. Some road administrations may allocate specific amounts of labour, equipment and materials whose costs are charged for the whole year regardless of use. Others may only define a total budget and leave the maintenance engineer free to purchase materials and hire whatever labour and equipment are needed. In most cases, the procedures will fall somewhere between these extremes.

7.38 A convenient method of developing the prioritised works programme is to produce a paper form for each maintenance activity that is needed. The form can contain a summary of the resource requirements and estimated costs for the activity. The forms should all be placed in a ring binder, initially following the order of priority defined in the master list, with the top priority tasks at the front and the lowest priority tasks at the end. The order of the forms in the file can be changed where necessary to take account of local conditions, as described above. By working through the file, the maintenance engineer can calculate how far the available resources will extend. It is therefore possible to identify which activities can be included in the programme for the year, and which tasks must be deferred until at least the next financial year. Some flexibility and adjustment of priorities may be necessary to make sure that all the funds available are used. As noted above, programming must be carried out separately for each budget head.

7.39 If computer-based spreadsheets are available, then these can provide a very convenient mechanism for carrying out the programming activity.

7.40 Where funds are particularly short, it may only be possible to undertake a small fraction of the required works. The temptation to spread available funds thinly over the whole network should be avoided in this case, since this will lead to the whole network becoming unserviceable over time. It is better to identify a 'core network' of strategic and economic importance and to focus the funding on these roads only. This will at least ensure that part of the network remains serviceable, and will reduce future rehabilitation needs. Identification of a core network needs to be covered in the road maintenance policy (see Chapter 2). However, admitting the need for a core network can be politically contentious.

7.41 The works programme produced in this way needs to be presented in the format necessary for submission for budget approval. Normally, the budget awarded will be insufficient to fund all of the works identified. Depending on the budgeting process, the budget awarded may identify the specific works to be funded, or may only award a sum of money for undertaking a variety of activities. In the latter case, the prioritised work programme can be used to define those works that are to be undertaken from the budget. The list of funded works becomes the 'commitment' for the coming year.

## 8 Preparation and operations management

---

8.1 Preparation and operations management have the following components:

- Preparation:
  - works design;
  - procurement by contract.
- Operations management:
  - contract supervision;
  - day-to-day management of works carried out by in-house teams.

### Works design

8.2 Whereas formal designs are needed for periodic and renewal works, most routine works do not need designing. Design methods are beyond the scope of this Note, but reference should be made to the methods indicated in Table 8.1 for activities.

**Table 8.1 Maintenance and renewal design methods**

---

<i>Activity</i>	<i>Design method</i>
<b><i>Routine</i></b>	
Patching, crack sealing and local sealing (asphalt).	<i>Overseas Road Note 2 (TRRL1985).</i>
Patching, crack sealing and joint repair (concrete).	<i>Concrete pavement maintenance manual (Highways Agency and Britpave 2001).</i>
<hr/>	
<b><i>Periodic</i></b>	
Fog and slurry seal (asphalt).	<i>Overseas Road Note 3 (TRL 2000), TRH3 (COLTO 1998).</i>
Otta seal.	<i>NPRA Publication No 93 (Norwegian Public Roads Association 1999).</i>
Surface dressing (asphalt).	<i>Overseas Road Note 2 or 3 (TRRL 1985, TRL 2000).</i>
Thin overlay (asphalt).	<i>Overseas Road Note 19 (TRL 2002).</i>
Regravelling (unpaved).	<i>Overseas Road Note 2 (TRRL 1985).</i>
<hr/>	
<b><i>Renewal</i></b>	
Overlay (asphalt).	<i>Overseas Road Note 18 and 19 (TRL 1999, 2002).</i>
Pavement reconstruction (asphalt).	<i>Overseas Road Note 31 (TRL 1993).</i>
Slab replacement (concrete).	<i>Concrete pavement maintenance manual (Highways Agency and Britpave 2001).</i>

---

### Procurement by contract

#### *Forms of contract*

8.3 Civil engineering contracts for maintenance and renewal works procurement can be categorised depending on the payment mechanisms used:

- Unit rate.
- Lump sum.
- Cost-plus.
- Target price.

The main features of contracts based on these payment types are described below.

8.4 In unit rate contracts, the works are broken down under a number of quantified items and listed in a bill of quantities. Prior to works execution, tenderers are requested to quote a unit rate for each of these items. The maintenance engineer will normally accept the lowest tender, and the unit rate becomes the basis for payment by measuring the work done under each item. The final cost of a unit rate contract can end up being considerably higher than the tender.

8.5 In lump sum contracts, the contractor is paid a fixed price for completing all works. A difficulty with this contract form is that the contractor's responsibility is assumed to include all work considered incidental to the completion of the contract, whether or not they are included in the contract documents. An experienced contractor should be able to foresee the need for incidental items and allow for their inclusion in the tender. However, problems can occur when the lump sum is deemed to cover risks that may substantially change the scope of the work to be carried out. High tender prices can result. Lump sum contracts can result in disputes on interpretation of the contract documents, other than for very simple and straightforward works.

8.6 In cost-plus types of contract, the contractor is paid the direct costs of personnel, machines and materials based on accounting records. The only competitive element is for tenderers to quote a percentage mark-up on the direct costs, or a fixed sum, to cover overheads and profit. Such an arrangement involves virtually no risks to the contractor, and guarantees a fixed income. However, it provides no incentives to carry out works in an efficient manner: the longer the work takes, the greater will be the payments made. Cost-plus contracts should only be used for works that are complex, and where quantities are difficult to assess in advance, such as bridge repairs.

8.7 Target price contracts add incentives of economy to the cost-plus arrangements. A preliminary cost is estimated and, on completion, the difference between this target and the actual cost is taken into account by calculating a positive or negative adjustment to the mark-up (or fixed sum) according to a pre-agreed formula. The target price approach can suffer from a lack of clarity about how awards and penalties are related to the contractor's performance. Unforeseen risks can cause the contractor to incur losses. Although target price contracts offer some advantages, a relatively sophisticated contracting environment is needed for them to be effective. In the absence of this, unit rate or lump sum contracts should normally be used.

### *Specifications*

8.8 There are two basic types of specifications that can be used in maintenance and renewal contracts:

- 'Procedural' (or 'method') specification, where the employer defines details of the work to be carried out (sometimes known colloquially as a 'cook-book' specification).
- 'Functional' (or 'end-product') specification, where the employer defines the result to be achieved by the work in terms of a functional or performance requirement.

8.9 Procedural specifications have been used traditionally for roads works. They are relatively easy to specify and to measure. They have relatively high supervisory requirements, particularly for maintenance works.

8.10 Functional specifications are, in principle, attractive for road maintenance works contracts. However, they require a fundamentally different way of working to conventional contracts. Contractual performance is defined in functional terms, such as required maximum depth of rutting, maximum height of grass on the verge, etc. Contractors can then determine the most appropriate way to meet the performance requirement that maximises the use of their own particular skills, equipment and use of materials. Supervision requirements are therefore minimised, since it is only necessary to test the end result on a sample basis. The main difficulty with functional specifications is the need to describe and define the functional requirements for all activities. Although this approach can be used in 'lengthworker contracts' (see below), its more general use is only recommended where there is considerable experience of contracting and a mature contract market.

8.11 A particular form of functional specification is used in 'lengthworker contracts', which can be effective for the routine maintenance of low-volume unpaved roads. 'Lengthworkers' are employed, on a contract basis, to carry out routine maintenance activities on specific sections of road, typically 1.5-2.0km in length. Work is undertaken on the basis normally of a simple contract

letter. Hand tools and a wheelbarrow may need to be provided. The contractor is expected to live close to the road, so that transport is not needed, and to work part-time on the road (typically 12 days per month). Activities include clearing ditches and vegetation, and repairing pot-holes. The work is typically inspected once-a-month to ensure that road conditions are satisfactory, and to make payments. If road conditions do not meet contractual targets, then payments can be reduced. Persistent poor performance can result in the contractor being replaced.

### *Contract procedures*

8.12 Contracts are generally complex legal documents, so standard contract documents are normally used. The most widely recognised forms of standard contracts are produced by the Fédération Internationale des Ingénieurs-Conseils (FIDIC) and the UK Institution of Civil Engineers (ICE):

- FIDIC conditions of contract for construction, for traditional contracts where the employer prepares the design (FIDIC 1999a).
- FIDIC short form of contract, for small and simple contracts (FIDIC 1999b).
- ICE standard conditions of contract (Institution of Civil Engineers 1996).

General advice on contracting out road maintenance activities is given by the World Bank (Lantran 1990-1993).

8.13 For contracts awarded to the private sector, a select list of tenderers should be maintained on the basis of type of work and range of value. Such lists should be compiled by vetting financial performance and previous experience of respondents to public advertisements. Standard tendering procedures should be adopted, and the following general principles adhered to:

- Non-commercial matters should not be considered when drawing up select lists; bias is to be avoided.
- Contractors on the select list should be those able to provide the least expensive tenders while competent to undertake work to the satisfaction of the client.
- All contractors on the select list should be given the opportunity to tender from time-to-time.
- The number of contractors invited to tender should be between four and six; sufficient numbers for competition, but not so excessive as to waste effort and increase the level of contractor tendering costs unnecessarily.
- Tenders should be received at a time and place notified in the tender invitation, opened in the presence of authorised representatives, recorded and evaluated in an unbiased way.
- The road administration should not be bound to accept the lowest tender, if there are good reasons to expect that a better result would be obtained by accepting a more expensive tender.
- Details of tenders should be made public, but commercial confidences should not be unreasonably disclosed.

8.14 The following general principles apply to the effective management of contracts:

- Avoid unnecessary complex documentation.
- Standardise contract procedures as far as possible.
- Contracts should enable standards and specifications to be enforceable in a clear and unambiguous manner.
- The quality of work can be improved through the use of functional (end-product) specifications, but these can be difficult to set up to be effective.
- The size and scope of contract should aim to make the most efficient use of available resources, and spread fixed costs in an optimal way.

8.15 A key objective of works supervision is to achieve good quality work within programme and to budget, in accordance with the specification, drawings and other contract documents. The way in which work is performed is entirely the responsibility of the contractor, unless it conflicts with the contract documents or legislation. The client organisation should endeavour to provide supervisory staff resources with adequate relevant experience and training, together with testing and other back-up facilities to enable a satisfactory level of quality control to be achieved. External consultants should be used for this when there are insufficient skilled staff in-house. Factors which affect the desirable level of supervision include:

- Scale and type of work.
- Duration.
- Capability of contractor.
- Complexity of work.
- Type of contract and associated procedures.
- Third party liaison and safety requirements.
- Implications of defective work going unnoticed.
- Degree of definition provided by contract documents.

It is vital that the maintenance engineer ensures that all contracts are properly supervised, and that all specifications are met before payments are authorised. More detailed advice on contract supervision is given in *Road engineering for development* (Robinson and Thagesen 2004).

8.16 Standardised sampling procedures should be adopted that are in accordance with national standard documents, where applicable. The frequency of sampling should reflect variability in materials quality and the quality of materials production, mixing, transport and site procedures. Normally, sampling frequency will be prescribed in the specification, but may need to be modified to suit individual circumstances. Resources available for sampling and testing requirements should be in balance with the frequency of tests required, and take into account the speed of work necessary to avoid delay to subsequent operations.

8.17 Contractors should be notified immediately of work or materials not meeting specifications. Careful consideration should be given to the reasons for non-compliance before taking action. Possible actions include re-working the material, removing the material, reducing payment or obtaining a performance guarantee bond from the contractor.

### **Operations management of in-house works**

8.18 Once a committed work programme is available, the maintenance engineer needs to convert this into a work schedule that indicates how the work will be timed throughout the year. This is, essentially, a project management exercise. Use should be made of bar charts and resource diagrams to schedule when work is best undertaken and to balance the use of resources to ensure their high utilisation. If a computer is available, a standard project management software package can be used to assist with this process. Activities to be undertaken in the near future should be scheduled more accurately than those to be undertaken in future months. Schedules should then be firmed-up as time progresses. Scheduling needs to take into account the following aspects relating to activities:

- *Timing* – some activities must be carried out at particular times in the year; for example, grass grows more rapidly during the rainy season, and should therefore be cut at the end of this season; drains should be cleared before the rainy season starts.
- *Frequency* – some activities are required at regular intervals; for example, a gravel road may require regular grading or dragging of its surface to inhibit traffic-induced corrugations.
- *Dependency* – some activities can only be carried out once others have been completed; for example, surface dressing should be carried out only after any pot-holes have been patched.

8.19 In scheduling the work, the maintenance engineer should take account of the delivery periods for materials. If deliveries are likely to be uncertain, it is advisable to stockpile basic materials, such as aggregates, cement and bitumen. These will need to be stored securely and kept in good condition.

8.20 It is important to have sufficient basic equipment and tools to meet day-to-day requirements. The maintenance engineer will probably not be responsible for the supply of plant and vehicles, since this is usually handled separately within the organisation. Shortage of working equipment or vehicles is almost always a major symptom of inefficiency in maintenance organisations. The maintenance engineer should, therefore, be aware of the supply situation and ensure that equipment is systematically maintained in good working order. It is particularly helpful to establish a daily routine of equipment maintenance. This can be done through the following measures carried out by the maintenance engineer:

- Ensuring that operators appreciate the purpose and benefits of preventative maintenance, understand the maintenance needs of the equipment they use, and are trained to look after this equipment on a daily basis.
- Arrange for a regular supply of oil and grease, etc, to be made available; this supply will need secure storage facilities under the supervision of a storeman.
- Checking personally that the daily maintenance routine is being carried out, and demonstrating personal concern for equipment maintenance standards.
- Using site visits to observe how operators treat their equipment and discouraging its mishandling or misuse.

Guidance on equipment management is beyond the scope of this Note, but further information is given by the World Bank (Lantran 1990-1993).

8.21 The maintenance engineer should prepare detailed work instructions for the teams under his direction, based on near-term activities included in the schedule. These are essentially sets of instructions that tell the foremen or technicians, supervising an activity, how much work is to be done each day, the time it should take, and the labour, equipment and materials to be used. Work instructions should cover periods of not less than two weeks and not more than four weeks. Shorter periods probably do not warrant the effort of preparing a work instruction, while longer periods risk losing a sense of urgency.

8.22 In drawing up work instructions, the maintenance engineer should first discuss the work with the foremen and supervisors who will have to manage the activity. It is essential for these personnel to feel confident that the 'production target' – the output of work required each day – is pitched at a realistic level. One useful idea is to ask the foremen to draft their own work instructions. The maintenance engineer can use these as a basis for discussion and agreement. The results are helpful in developing the work instructions that are issued to teams.

8.23 Figure 8.1 shows an example of a completed work instruction. Normally, two or more of these would be issued to cover the schedule period. The work instruction provides information on work to be carried out, resources to be used and targets to be achieved. It also provides a daily record of the progress made on a job to allow the actual output of work to be measured against the target output. The target is the first item to be recorded on the work instruction; the amounts of each resource to be used are entered next, in the top half of each line. The work instruction is then issued to the supervisor who enters, in the bottom half of each line, the progress actually made and the resources used day-by-day. At the end of the schedule period, the supervisor returns the completed forms to the maintenance engineer who calculates, in percentage terms, how much of the production target has been achieved and so is able to assess the productivity of the work. Any significant shortfalls that may occur, or instances of high achievement, can be discussed with the supervisory personnel when the next schedule is being prepared.

8.24 Technical aspects of the execution of maintenance activities at district level are the subject of *Overseas Road Note 2* (TRRL 1985). The organisation of work on site needs some consideration, particularly if large-scale in-house works are involved. Health and safety issues must be given due consideration, and work should be undertaken to meet any environmental legislative requirements.

**Work instruction**

District: <i>Central</i>		Period: <i>5-18 October 2003</i>								
Section: <i>A0102</i>		Sub -section: <i>2</i>								
Length: <i>225</i> metres		Width: <i>6.5</i> metres								
Activity: <i>Regravelling</i>										
Team members: <i>H Smith C Jones S Done</i>										
	Unit	M	T	W	T	F	S	S	Total	%
Target production	<i>km</i>	← <i>0.5km/day</i> →							<i>3.500</i>	<i>71</i>
									<i>2.490</i>	
Resources										
<i>Gravel (Subcontract)</i>	<i>m<sup>3</sup></i>	← <i>350m<sup>3</sup>/day</i> →							<i>2450</i>	<i>65</i>
		<i>300</i>	<i>300</i>	<i>100</i>	<i>100</i>	<i>400</i>	<i>0</i>	<i>400</i>	<i>1600</i>	
<i>Grader</i>	<i>hr</i>	← <i>8/day</i> →							<i>56</i>	<i>75</i>
		<i>6</i>	<i>8</i>	<i>8</i>	<i>4</i>	<i>8</i>	<i>b/d</i>	<i>8</i>	<i>42</i>	
<i>Roller (2)</i>	<i>hr</i>	← <i>16/day</i> →							<i>112</i>	<i>70</i>
		<i>16</i>	<i>16</i>	<i>7</i>	<i>8</i>	<i>16</i>	<i>-</i>	<i>16</i>	<i>79</i>	

Signed..... *Th. E. Engineer* .....

**Figure 8.1 Example of work instruction form**

In particular, labour-based methods will require careful organisation and management. Labour has to be available in sufficient numbers in the right place and at the right time, so arrangements may need to be made for transporting the labour force to and from work sites. Standardised, good-quality tools and equipment will be needed to achieve high levels of output. Attention should also be paid to the health and nutrition of the workers. In addition to the humanitarian aspect, this also helps to increase productivity.

8.25 Works performed in-house should generally be subject to the same level of supervision as that applied to external contractors.

8.26 The maintenance engineers must ensure that the contractor uses safe working practices on site. It may be helpful for the road engineer to explain to the contractor the impact that an accident will have on both the worker and their family. A schedule of penalties for non-compliance can be included in a contract. Site safety is often covered by national regulations but, in the absence of these, general safety issues are presented in Box 8.1.

## **Box 8.1 Site safety measures**

### *General operations*

Many labourers may be unfamiliar with site practices and equipment. Provide training for recruited labour on the dangers of site work, precautions (how to avoid danger) and protection (how to protect against harm).

### *Driving*

Many site accidents relate to driving. Ensure that only competent drivers work on the site. Warn and then dismiss drivers who drive poorly. Do not permit any driving under the influence of alcohol or drugs.

### *First aid*

All sites must have first aid facilities staffed by a trained health worker. Access to a nearby clinic must be possible at all times in case of more serious injury. For very small sites or mobile operations, at least one person in the team should have basic first aid training and carry a first aid kit.

### *Manual excavation*

A group of labourers working closely together can put each other at risk of injury. Instruct a supervisor to ensure that labourers are well spread out along a gravel quarry face or a drain excavation line.

### *Gravel pit excavation*

Vertical gravel faces can collapse and trap labourers. Excavate a maximum vertical face of one metre, with a horizontal step of at least two metres to the next face to reduce this risk.

### *Tractor operations*

Only drivers may sit on a moving tractor. No one should sit on mudguards or other parts of a tractor. All passengers should sit within, and not on the sides of, a towed trailer.

### *Equipment operations*

Instruct a worker to accompany all motorised plant to ensure that labourers are aware of its movements, particularly when reversing. Motorised plant should carry no passengers.

### *Clothing*

Activities such as concrete and asphalt work require specialised protective clothing. This can include gloves, boots, overalls, goggles, dust masks and face masks. Hot bitumen will require heat resistant clothing. Explain clearly the dangers of working with these materials. Ensure that the protective clothing is worn. Provide an adequate supply of cleaning materials.

### *Rock breaking*

Issue all workers who produce chippings or aggregate with goggles and gloves. Ensure that the protective equipment is worn.

### *Tree felling*

Trees can fall in unexpected directions. Maintain a clear area of radius greater than the height of the tree. One worker should announce when the tree is ready to fall.

### *Traffic management*

Place warning signs in front of and behind each work gang at a sufficient distance to enable vehicles to slow down and stop. One worker with a flag should be present at each end of the works to warn drivers of the activities ahead. If the road is blocked, make a detour available at all times. See *Overseas Road Note 2* (TRRL 1985), or national guidance, for recommended sign layouts.

### *Lengthworkers*

Lengthworkers are vulnerable to traffic accidents when working alone. The lengthworker should place warning signs along the road in both directions before starting work.

### *Public safety*

Roads are public places. Ensure that members of the public are protected from site activities. Provide pedestrian detours, if necessary. When closing gravel pits, batter back all vertical faces. Instruct equipment operators to drive slowly, especially on small access roads with poor visibility. Protect culvert excavations with barriers. A contractor may be legally required to provide third-party insurance against injury to people and damage to property when on site.

## 9 Monitoring and audit

---

9.1 Monitoring and audit represent the final step in the management cycle for undertaking an activity. Both should be carried out to review each of the network management activities of programming, preparation and operations management. 'Monitoring' provides feedback to the management process, whereas 'audit' provides a check on how a particular activity has been carried out.

9.2 The audit function is, essentially, a physical integrity check to ensure that:

- Work has actually been undertaken, where specified, to any pre-defined standards, specifications or procedures – this is known as 'technical audit'.
- Funds have been spent for the purposes actually intended, and that costs and other resources have been accounted for properly – this is known as 'financial audit'.

Auditing is normally done on a sample basis by a special unit, which is independent of the main functional branches of the road administration. The three key areas over which control needs to be exercised are:

- Quality of work.
- Final cost of work.
- Duration of work.

9.3 Monitoring enables management to learn from past experience. For example, aims can be redefined to reflect the actual achievements; cost assumptions can be revised to reflect those actually achieved in practice; procedures, technical methods and specifications may be improved as a result of monitoring. Thus, monitoring enables the maintenance engineer to check the quality and effectiveness of the work being done. It provides data that can be used to improve the management and performance of future maintenance operations. Questions asked should include:

- Are the objectives and desired levels of service being achieved?
- Are the works being completed satisfactorily?
- Is value-for-money being obtained?

9.4 Key objectives from the road maintenance policy framework should be selected as performance indicators. These can be made public to give confidence to those using the road network that its management is effective and efficient. The same performance indicators should be used irrespective of whether works are carried out by an in-house unit or under contract. Some indicators of effectiveness and value-for-money are given in Box 9.1.

### **Box 9.1 Examples of performance indicators**

#### *Indicators of effectiveness*

- Volume of the various works carried out against that planned for each activity
- Trends relating to changes in network condition
- Expenditures per kilometre on different road classes for different treatment types
- Value and proportion of maintenance carried out on a year-by-year basis
- Cumulative amount of network treated or upgraded

#### *Indicators of value-for-money*

- Out-turn unit costs of works undertaken
- Time and cost over-runs

## 9.5 Monitoring involves:

- Site visits.
- Desk review.

Site visits are an important part of monitoring. Because of the length of road to be covered, site visits will require the use of a vehicle, which should be driven slowly along the section being examined. Enough time should be allowed for the maintenance engineer to make a series of detailed inspections on foot. It is therefore best if the engineer travels as a passenger to concentrate on the inspection, with a driver being responsible for the progress and safety of the vehicle. The road surface, side drains, culverts and soils all need to be examined.

9.6 Desk review is an office task that involves reviewing all the maintenance documentation, i.e. inspection reports, completed worksheets, etc. It provides the opportunity to assess the performance of the maintenance programme and the effectiveness of the management system. It provides an opportunity to check that adequate resources were allocated to each task and that maintenance problems were treated efficiently; cost estimates can be compared with expenditure and production targets with output; and the reasons for inconsistencies or shortfalls can be identified. In some cases, resources may have been insufficient; in others, targets may have been pitched too high.

9.7 The maintenance engineer should discuss the results of the desk review with supervisors and try to find ways of remedying any deficiencies. It is likely that some of these may result from factors beyond the control of the maintenance staff, but it should be possible to identify those points that can be put right and to plan appropriately for the following year.

## 10 Information systems

---

10.1 Computerised information and management systems can be used to assist with most aspects of the road maintenance management process. The need to collect, store and utilise significant amounts of information about the road network makes a computer-based approach very attractive. Many proprietary systems are available. Detailed guidance on the design, selection and operation of road management systems is provided in *Overseas Road Note 15* (TRL 1998). It is crucial that a systematic approach is used for selecting and implementing systems. A summary of the recommendations in this area are given in Box 10.1.

10.2 Past experience suggests that the following are key issues that must be met when implementing systems to support the maintenance management process:

- The system must be adapted to suit the local conditions.
- Existing methods and procedures that cannot be used unchanged should be modified rather than replaced with new ones.
- Sufficient, well trained and motivated staff must be provided.
- The introduction of the system must be properly supervised.

### **Box 10.1 Steps in the system selection process**

#### *1 Commitment phase (decide to proceed)*

- Obtain commitment from key individuals in the road administration to the system implementation process.

#### *2 Requirements phase (decide what is wanted)*

- Agree the objective for the system and determine what components the system needs to contain; decisions should be supported by cost-benefit analysis.

#### *3 Specification phase (decide what is needed)*

- Identify users of the system and the outputs that they will require to support them in their management decision-making.
- Identify data needs and models required to produce these outputs.

#### *4 Procurement phase (choose the best solution)*

- Identify appropriate software, together with hardware and operating system requirements necessary to support it.

#### *5 Operations phase (make the system work)*

- Implement the chosen system.
- Provide initial and on-going training.
- Manage operation of the system.

## References

---

- Committee of Land Transport Officials (COLTO) (1998).** *Technical recommendations for highways: surfacing seals for rural and urban roads.* Draft TRH3. Pretoria: Committee of Land Transport Officials.
- Fédération Internationale des Ingénieurs-Conseils (FIDIC) (1999a).** *Conditions of contract for construction.* Lausanne: Fédération Internationale des Ingénieurs-Conseils.
- Fédération Internationale des Ingénieurs-Conseils (FIDIC) (1999b).** *Short form of contract.* Lausanne: Fédération Internationale des Ingénieurs-Conseils.
- Highways Agency and Britpave (2001).** *Concrete pavement maintenance manual.* Crowthorne: The Concrete Society.
- Institution of Highways and Transportation (IHT) (1990).** *Highway safety guidelines: accident reduction and prevention, international edition.* London: Institution of Highways and Transportation.
- Institution of Civil Engineers (1996).** *The engineering and construction contract.* London: Thomas Telford, 2nd edition.
- Lantran J M (1990-1993).** *Contracting out road maintenance activities.* Volumes I-IV. Sub-Saharan Africa Transport Policy Program, Road Maintenance Initiative. Washington DC: The World Bank.
- Norwegian Public Roads Association (1999).** *A guide to the use of otta seals.* Road Technology Department, International Division, Publication No 93. Oslo: Directorate of Public Roads.
- PIARC (1999).** *HDM-4: highway development and management tool.* The Highway Development and Management Series. Paris: PIARC World Road Association.
- Robinson R, Danielson U and Snaith M (1998).** *Road maintenance management: concepts and systems.* Basingstoke: Macmillan Press.
- Robinson R and Thagesen B (2004).** *Road engineering for development. (In preparation).*
- Transport Research Laboratory (TRL) (1991).** *Towards safer roads in developing countries: a guide for planners and engineers.* Crowthorne: TRL Limited.
- Transport Research Laboratory (TRL) (1993).** *A guide to the structural design of bitumen-surfaced roads in tropical and sub-tropical countries.* Overseas Road Note 31. Crowthorne: TRL Limited.
- Transport Research Laboratory (TRL) (1998).** *Guidelines for the design and operation of road management systems.* Overseas Road Note 15. Crowthorne: TRL Limited.
- Transport Research Laboratory (TRL) (1999).** *A guide to pavement evaluation and maintenance of bitumen-surfaced roads in tropical and sub-tropical countries.* Overseas Road Note 18. Crowthorne: TRL Limited.
- Transport Research Laboratory (TRL) (2000).** *A guide to surface dressing in tropical and sub-tropical countries.* Overseas Road Note 3 (2nd edition). Crowthorne: TRL Limited.
- Transport Research Laboratory (TRL) (2002).** *A guide to the design of hot mix asphalt in tropical and sub-tropical countries.* Overseas Road Note 19. Crowthorne: TRL Limited.
- Transport Research Laboratory (TRL) (2003).** *A guide to the measurement of axle loads in developing countries using a portable weighbridge.* Overseas Road Note 40. Crowthorne: TRL Limited.

**Transport and Road Research Laboratory (TRRL) (1985).** *Maintenance techniques for district engineers.* Overseas Road Note 2 (2nd edition). Crowthorne: TRL Limited.

**Transport and Road Research Laboratory (TRRL) (1988).** *A guide to bridge inspection and data systems for district engineers, Volumes 1 and 2.* Overseas Road Note 7. Crowthorne: TRL Limited.

## Appendix A: Glossary

---

<i>Activity</i>	Any work or intervention that is carried out on the road network, including works to undertake road maintenance, new construction, improvements, and the like.
<i>Audit</i>	A physical check, usually on a sample basis, that work has been carried out, where specified, to pre-defined standards or procedures, and that costs and other resources have been accounted for properly.
<i>Budget head</i>	A category under which a budget is broken down for the purposes of its allocation.
<i>Capital budget</i>	The government budget normally used to fund major projects.
<i>Carriageway</i>	That part of the road used by traffic.
<i>Chainage</i>	Distance measured along the road from a defined datum.
<i>Client</i>	The body commissioning works or services.
<i>Committed works</i>	Works for which a budget has been approved.
<i>Condition-responsive treatment</i>	Works that are carried out in response to defects exceeding a defined threshold.
<i>Construction</i>	'Development works'.
<i>Contract</i>	An agreement between two willing parties to perform some action, where there has been an 'offer', an 'acceptance' and a 'consideration' (usually money).
<i>Contractor</i>	The supplier of works or services under a contract.
<i>Contractual claim</i>	A request made by a contractor for additional payment or an extension of time necessary to undertake works that are unforeseen or not specified in the contract.
<i>Core road network</i>	That part of the road network, normally of a strategic nature, that will always be maintained even when available resources are extremely limited.
<i>Cost-plus contract</i>	Works contract where the contractor is paid for monies actually spent plus a mark-up for overheads and profit.
<i>Customer</i>	The beneficiary of a service being provided. The main customers for a road administration are the road users, who include: owners and operators of commercial vehicles and buses; representatives of industry, commerce and agriculture, who have a vested interest in an efficient road network to support their business operations; and the travelling public using the road network.
<i>Cyclic works</i>	Routine maintenance works carried out each year whose frequency depends on environment and not traffic.
<i>Data</i>	Facts (quantities, values, names, etc) from which other information may be inferred.
<i>Defect</i>	Deteriorated from new condition.
<i>Designated road</i>	A road that is a legal entity under a Roads Act or similar legislation (the terms 'adopted', 'declared', 'gazetted', 'proclaimed' are used in some countries).
<i>Development works</i>	Works which extend the capacity of the network by widening, realignment or constructing a new section.
<i>Direct labour</i>	'In-house works implementation'.
<i>Emergency works</i>	Works carried out on the network to reopen a cut or blocked road.

<i>Equipment-based works</i>	Works that are undertaken mainly with the assistance of mechanical equipment.
<i>Gazetteer</i>	A list of designated links or sections that defines the road network.
<i>Feature</i>	A fundamental component of the road, such as the carriageway, shoulder, footway, etc.
<i>Force account</i>	‘In-house works implementation’.
<i>Functional specification</i>	A specification that is defined in terms of the end-result to be achieved.
<i>In-house works implementation</i>	Works undertaken by a unit of the client’s own organisation.
<i>Information</i>	Data that has been transformed to be meaningful through processing and dissemination.
<i>Intervention level</i>	The threshold above or below which action must be taken to ensure that standards are met, often expressed in terms of defined thresholds of road condition, response time, or performance.
<i>Inventory</i>	The physical attributes of the road or other asset being managed.
<i>Labour-based works</i>	Works that are undertaken mainly by manual labour with the assistance only of tools and small items of mechanical equipment.
<i>Lengthworker</i>	An individual responsible for carrying out maintenance works on a defined length of road.
<i>Level of service</i>	A subjective measure of user requirements.
<i>Link</i>	A length of road where traffic volumes are reasonably uniform.
<i>Lump sum contract</i>	Works contract where the contractor is paid a pre-agreed fixed sum for all works carried out.
<i>Maintenance</i>	The group of works that enables a road to continue to provide an acceptable level of service. Maintenance reduces road deterioration, lowers road user costs, and keeps the road open on a continuous basis.
<i>Management</i>	The planned and organised use of resources to achieve particular goals or objectives.
<i>Management cycle</i>	A series of well-defined steps which take the management process through the decision making tasks. Typical steps would be i) define aims; ii) assess needs; iii) determine options; iv) choose actions; v) implement activities; vi) monitor and audit. The process typically completes the cycle once in each periodic cycle of the particular management function.
<i>Management system</i>	A set of procedures to assist with management.
<i>Marker post</i>	A fixed item at the roadside to indicate location.
<i>Mission (statement)</i>	This outlines, in broad terms, the nature of the operation being managed by the organisation responsible for the road network.
<i>Monitoring</i>	Reviewing past activities to learn from experience to enable better objectives to be set in the future.
<i>Moving observer count</i>	Method of determining traffic flow whilst driving along a length of road.
<i>Network</i>	A particular grouping of roads for management purposes; examples are the national road network; trunk road network; paved road network, etc.
<i>Network management</i>	The process of managing a road network, including the activities of ‘strategic planning’, ‘programming’, ‘preparation’ and ‘operations management’.
<i>Network referencing</i>	The process of breaking the road network down into successively smaller links, segments and sections, each of which can be defined uniquely for road management purposes.

<i>Network screening</i>	Preliminary determination of which road sections are likely to need treatment.
<i>Node</i>	The start and end point of a road section.
<i>Objective</i>	A specific and measurable goal or target to be achieved by a body within the short to medium term (tactical) or long term (strategic) time scale.
<i>Operation(s)</i>	The on-going activities of an organisation, decisions on the management of which are made on a near-term basis, typically daily or weekly, including the scheduling of work to be carried out, monitoring in terms of labour, equipment and materials, the recording of work completed, and the use of this information for monitoring and control.
<i>Operational cost</i>	A fundamental cost-estimating technique that compiles the total cost of the work from consideration of the constituent operations or activities revealed by the method statement and programme, and from the accumulated demand for resources.
<i>Overlay works</i>	The addition of material on top of a pavement for the purpose of increasing its structural strength.
<i>Performance bond</i>	An unconditional bank guarantee, in favour of the client, that a contractor will meet all contractual requirements.
<i>Performance indicator</i>	A sub-set of objectives, performance against which is published for public scrutiny.
<i>Performance standard</i>	This specifies the resource requirements for each activity to be carried out, and builds up a consistent description of the activity based on a preferred and specified method of working, and resources of equipment, labour and materials to perform the activity in accordance with the preferred method.
<i>Periodic works</i>	Works carried out on the network planned at discrete intervals in time of several years.
<i>Planning (strategic)</i>	This involves an analysis of the road system as a whole, typically requiring the preparation of long term, or strategic, estimates of expenditure for road development and conservation under various budgetary and economic scenarios; predictions may be made of expenditure under selected budget heads, and forecasts of road conditions, in terms of key indicators, under a variety of funding levels.
<i>Policy</i>	The statement or series of statements which define the basic rules and requirements which can guide all decisions and actions that need to be taken.
<i>Policy framework</i>	A hierarchical set of statements that define policy relevant to different bodies or levels of administration; typically consisting of mission statement, objectives and standards that define in detail the aims of an organisation and how it proposes to achieve these.
<i>Preparation</i>	The near-term planning stage where road schemes and projects are packaged for implementation. At this stage, designs are refined and prepared in more detail; bills of quantities and detailed costings are made; together with work instructions and contracts; detailed specifications and costings are likely to be drawn up.
<i>Preventive works</i>	Periodic works on the network designed to prevent the rapid escalation of deterioration.
<i>Priority index</i>	A parameter whose numerical value indicates where in a list of priorities particular actions lie.
<i>Procedure</i>	A documented series of steps for carrying out a particular activity or task.

<i>Procedural specification</i>	A specification that is defined in terms of the method to be followed.
<i>Programming</i>	The preparation, under budget constraints, of multi-year works and expenditure programmes in which those sections of the network likely to require treatment, and new construction possibilities, are identified and selected; a tactical planning exercise.
<i>Project</i>	A set of activities with a defined start and finish, and which consume resources in moving from start to finish.
<i>Quality control</i>	Checking completed works to ensure that specifications have been met.
<i>Rating</i>	A score assigned to indicate condition or priority.
<i>Reactive works</i>	Routine maintenance activities that are carried out each year whose extent depends on a combination of traffic and environmental effects.
<i>Reconstruction</i>	Works requiring the replacement of some of the existing infrastructure asset; e.g. pavement reconstruction requiring removal and replacement of road surfacing material.
<i>Recurrent budget</i>	The budget head often used to fund on-going activities and maintenance works.
<i>Rehabilitation</i>	Works that are needed to restore a road to a maintainable condition.
<i>Renewal</i>	Works to restore a road to a similar condition to when it was new.
<i>Resurfacing works</i>	The addition of material on top of a pavement for the purpose of reducing roughness or surface distress.
<i>Road administration</i>	The body responsible for managing the road network.
<i>Road class</i>	A grouping of road sections according to pre-defined rules, often based on issues of ownership, function, funding source, etc.
<i>Road management</i>	The process of maintaining and improving the existing road network to enable its continued use by traffic efficiently and safely, normally in a manner that is effective and environmentally sensitive; a process that is attempting to optimise the overall performance of the road network over time.
<i>Roads board</i>	A committee set up to administer or to advise on the administration and management of a road network.
<i>Roads register</i>	A 'gazetteer'.
<i>Roughness</i>	Longitudinal unevenness of the road surface that impacts on the suspension of vehicles.
<i>Routine works</i>	Works carried out on the network that are needed each year.
<i>Schedule</i>	A short to medium term plan for carrying out activities.
<i>Scheduled treatment</i>	Works that are carried out at pre-defined intervals of time.
<i>Section</i>	A length of road that is reasonably uniform in terms of its physical characteristics.
<i>Serviceability</i>	'Level of service'.
<i>Specification</i>	A detailed description of the attributes of the output from an activity, or of the steps by which that activity is carried out.
<i>Standard</i>	A detailed operational target to be achieved by an individual unit in an organisation to enable policy to be implemented; a requirement, sometimes legally enforceable, that a road administration is obliged to meet as part of its road management activity.
<i>Target price contract</i>	Works contract where the contractor is paid a fixed price plus an incentive payment for meeting pre-defined targets.
<i>Task</i>	A sub-division of an activity.

<i>Tender</i>	A formal written offer to carry out works, or to supply goods, material or services.
<i>Treatment</i>	Works to correct defects.
<i>Treatment length</i>	Contiguous lengths of road requiring common treatments.
<i>Treatment option</i>	One of a number of treatments that can be applied to correct the same defects.
<i>Unit rate</i>	A cost-estimating technique based on the traditional bill of quantity approach to pricing engineering work, typically relating to aggregate quantities of work to be carried out, measured in accordance with an appropriate method of measurement.
<i>Upgrading</i>	Works to increase the standard of a road; e.g. pavement strengthening, road widening.
<i>Utility</i>	Public service infrastructure; e.g. telecommunications, electricity, water.
<i>Visual inspection</i>	An inspection based on the use of simple measurements, or on subjective judgement.
<i>Work package</i>	A collection of works that are carried out under one contract or work instruction.
<i>Works</i>	All construction and maintenance activities that are carried out on the road network, normally sub-divided into routine maintenance, periodic maintenance, special works, rehabilitation, and development.
<i>Work order/instruction</i>	Written authorisation to carry out certain works.

## Appendix B: Field survey procedures

---

### Survey types

B.1 Three types of inspections are covered in this Note:

- Inventory.
- Network screening survey.
- Visual inspection.

The first section of the appendix deals with network screening surveys. The remainder of the appendix covers the procedures for visual inspections. Inventories and visual inspections use largely the same field procedures. The recommendations for team organisation, safety, equipment and transport are common for the two types of surveys. The forms required for inventory surveys will depend on the details of the network and item inventory to be recorded. No specific examples are included here. Standard forms for recording the results of network screening surveys and visual inspections are included in Appendix D.

### Network screening surveys

B.2 The aim of network screening surveys is to identify the need for the more detailed visual inspections.

B.3 A network screening survey is carried out on the basis of road sections, rather than sub-sections. It is undertaken by an observer from a moving vehicle. This is a subjective, cursory, inspection which assigns a 'rating' in the range of 5 (good) to 1 (poor), which relates to 'serviceability'. Separate ratings are assigned to pavements, shoulders or footways, and to side drainage. In the case of shoulders and footways, one value is assigned to represent the serviceability of all shoulders and footways in the section on both sides of the road.

B.4 The maintenance engineer should develop an appropriate rating mechanism for local conditions. In the absence of this, or as a starting point, one of the following methods can be used. A simple rating method can be used for pavements by assigning a general rating, on a scale of 5 (excellent) to 1 (poor), to the general condition of each section. The results can be used directly. The observer should also make a note of the likely remedial treatment needed on the section to guide the analysis of survey results. Any special problems should also be noted.

### *Complex rating of pavements*

A more detailed rating method can also be used to take into account specifically the riding quality and surface deterioration of the pavement. For each section, two ratings are made. The first relates to the perceived riding quality, and the second to the percentage length of the section that is defective. Appropriate ratings are given in Table B.1. The observer records the characteristic riding quality of the section. In addition, the percentage length of the section that has characteristic defectiveness should also be recorded. Figure B.1 shows an example of how these values can be entered on a survey form. The two ratings can be combined, as shown in Table B.2, and an overall rating can be read from the matrix. As above, the observer should make a note here of likely remedial treatment needed on the section and other relevant information.

**Table B.1 Pavement rating for riding quality and defectiveness**

<i>Perceived riding quality of pavement</i>	<i>Initial rating</i>
Smooth	5
Occasional slight unevenness	4
Continuous slight unevenness or occasional bump	3
Continuous unevenness	2
Continuous rough ride	1
Road impassable	0



**Table B.2 Combination of initial ratings to give a pavement rating**

<i>Perceived riding quality</i>	<i>Percentage length defective</i>				
	<i>0-5</i>	<i>6-10</i>	<i>11-20</i>	<i>21-50</i>	<i>51-100</i>
5 Smooth	5	4	3	2	2
4 Occasional slight unevenness	4	4	3	2	2
3 Continuous slight unevenness or occasional bump	3	3	3	2	1
2 Continuous unevenness	2	3	3	2	1
1 Continuous rough ride	1	1	1	1	1
0 Road impassable	0	0	0	0	0

B.6 During the survey, the observer should also record a rating for shoulders or footways, and for side drains, as illustrated in Figure B.1. As above, the maintenance engineer should develop an appropriate rating mechanism for local conditions but, in the absence of this, the values indicated in Table B.3 can be used.

**Table B.3 Rating for shoulders, footways and side drains**

<i>Percentage length defective</i>	<i>Rating</i>
0-5	5
6-10	4
11-20	3
21-50	2
51-100	1

### **Visual inspection procedure**

B.7 The procedures given can apply to sections of a constant (fixed) length or to variable-length sections. Surveys can be carried out of entire sections, or these can be broken down into sub-sections to provide shorter and more convenient road lengths for reporting purposes. Typical sub-section lengths would be 100 to 200 metres.

B.8 The aim of visual inspections is to record defects occurring in sections of road. The inspections are designed to be carried out by non-technical staff who have been trained in the relevant survey techniques. As such, inspectors are not expected to make decisions about the cause of defects or to make other engineering judgements. It is envisaged that, for maintenance and renewal treatment-design purposes, a more detailed engineering inspection will be utilised in addition to the visual inspection, in which cores and other detailed site investigations will be carried out. These investigations are described in *Overseas Road Note 18* (TRL 1999).

B.9 Because visual inspection is a time-consuming process, it may only be possible, initially, to take representative measurements over perhaps one-tenth of the section or sub-section length. As inspection teams become more skilled and as more teams are introduced, it should become practicable to increase the coverage of the surveys until measurements are taken over the entire section. Similarly, when the maintenance system is first introduced, it will probably only be possible for the inspector to assess the severity of defects by observation. As the system develops, physical measurement of defects should be gradually introduced into the inspection procedure; but the quality of visual assessments can be improved by having first-hand knowledge of the physical measurement techniques.

## Visual inspection organisation

### *Safety*

B.10 Safety is a key aspect of the work. The road being inspected may have vehicles travelling at high speed. Any person working on the road should, therefore, take simple and sensible precautions. Even when traffic is not heavy, safety procedures should not be relaxed, since there may then be a danger from unexpected vehicles.

B.11 All members of field survey teams, including drivers and any labourers, should wear high visibility safety jackets at all times during surveys. The transport vehicle should follow directly behind the survey team, and remain between the team and the traffic. The vehicle's hazard warning lights should be switched on and, whenever possible, a 'men-at-work' sign should be attached to the vehicle, or placed behind it.

B.12 Where possible, inspections on foot should be carried out while standing on the shoulder or footway. When measurements are being made on the carriageway by an inspector, another team member should act as a lookout to warn of oncoming traffic. To minimise exposure to traffic, inspectors and team members should only step on to the carriageway when actually taking measurements. Particular care should be taken when measuring rut depth on the far side of the road, since the transport vehicle will not be providing safety cover.

B.13 Inspectors should report all road defects that affect road safety, even where there may be no specific requirement to do this in the survey being undertaken. Where paper based inspections are used, notes can be recorded on the inspection form. If an unsafe situation is observed, remedial action should be undertaken by the inspectors, wherever possible. For example, if there is debris on the road, then this should be removed rather than reported. Examples of safety hazards to be reported are:

- Traffic accidents.
- Broken down vehicles on the road.
- Landslide debris on the road or endangering the road.
- Other debris.

### *Equipment and transport*

B.14 Table B.4 sets out a check-list of the equipment required for the field work of inspections.

**Table B.4 Equipment for inspections**

<i>Item no</i>	<i>Description</i>
1	Transport.
2	Warning signs ('men-at-work').
3	High visibility safety jackets.
4	List of sections to be inspected and maps of the area.
5	Field survey procedures (this document).
6	Printed inspection forms.
7	Clip-boards.
8	Ballpoint pens or pencils.
9	Inspector's notebook.
10	Measuring wheel or 30m measuring tape.
11	10m measuring tape or second measuring wheel.
12	Deformation gauge (two-metre straight-edge and calibrated wedge - see Figure B.2).
13	Road marking crayons or chalk.

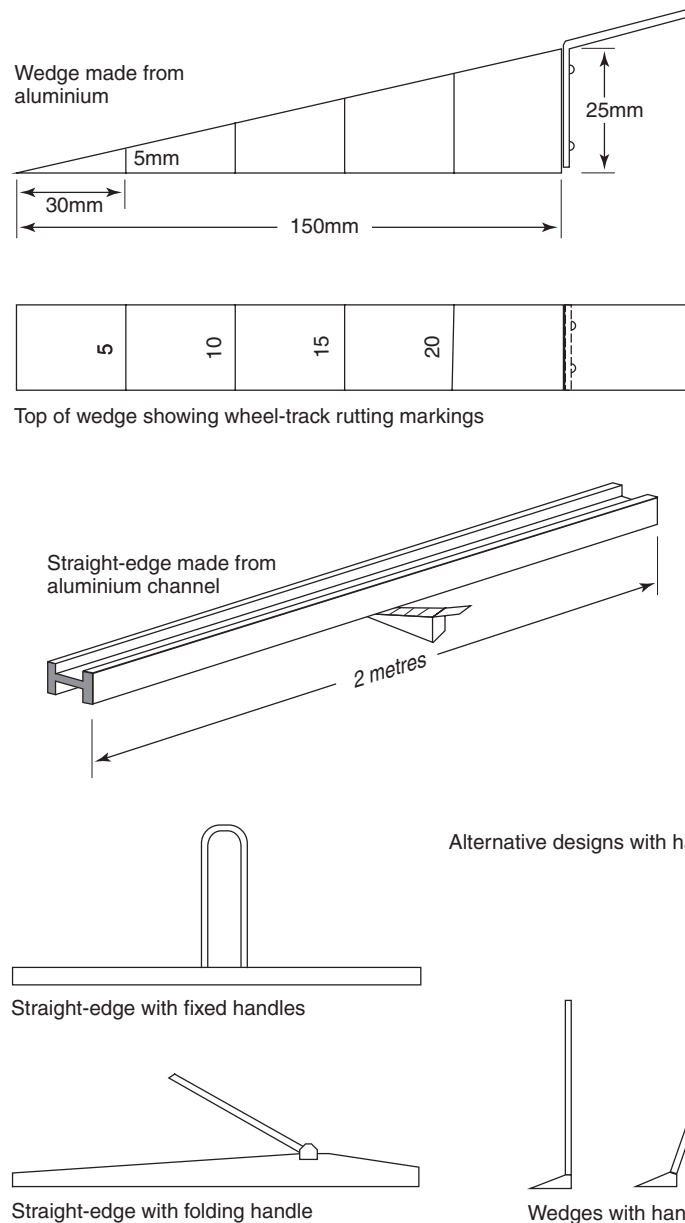

**Figure B.2 Deformation gauge (straight-edge and wedge)**

B.15 Transport is needed to carry teams to and from their place of work, to carry equipment, and to give temporary shelter during bad weather. The vehicle provides safety protection to the inspection team when working on the road. There is particular advantage if flashing roof-lights and ‘men-at-work’ warning signs can be attached to the vehicle for display when teams are working. The vehicle should display hazard warning lights when parked or moving slowly on the road.

***Organisation and staffing of teams***

B.16 The basic duties of the team are the observation, measurement and recording of defects. Composition of the team will depend upon local circumstances and the type and category of road. But, normally, the team will consist of a team leader, an assistant and a driver. When traffic densities are high, an additional assistant is useful for safety purposes and to help direct traffic. The following are the duties of the team members:

- *Team leader* – has overall responsibility for the work of the team and, in particular, for all safety aspects; should carry out the detailed measurements and recording of defects; should normally push the measuring wheel along the left-hand edge of the carriageway; make any notes on any safety defects or other urgent actions which should be brought to the attention of the engineer

- *First assistant* – will work on the opposite side of the carriageway to the team leader and assist with the detailed measurement of defects; should carry the deformation gauge and make the measurements of rut depth
- *Driver* – is responsible for transporting the team to site; should drive the vehicle on the carriageway immediately between the traffic and the inspection team, and switch on its hazard warning lights
- *Second assistant* – should be used on heavily trafficked roads; principal task should be to warn team members of approaching traffic, but can also assist with measurement
- *Labourers* – may be used to assist with surveys or to carry equipment; when on site, they must wear safety jackets and obey the same safety rules as other team members; note that having too many members can hinder safe working

### **Visual inspection procedure**

B.17 In a visual inspection, defects are measured by hand within each section of road.

B.18 Before leaving the office, the team leader should obtain a list of sections to be inspected. The team leader should check personally that all of the inspection equipment needed has been collected together and loaded in the vehicle. They should ensure that the vehicle has sufficient fuel.

B.19 Once on site, the team leader must establish the start of the length to be inspected. Each section is normally identified uniquely by a label and a written description.

B.20 The team leader sets up the measuring wheel at the edge of the carriageway at the start of the sub-section to be inspected. The first assistant starts on the opposite side of the carriageway and carries the deformation gauge. The driver places the vehicle on the carriageway, with hazard lights flashing, behind the team leader. The driver should be ready to follow immediately behind the team as they progress along the section. It is helpful if a second assistant can be made available to work with the team leader. Once on site, the team leader records details of the section label, and measures the width of the carriageway and shoulders or footway.

B.21 The team then walk along the section, identifying, measuring and recording defects. Normally, the start and end chainage of defects are recorded but, in addition, the team should pause every 100 metres to check that defects currently recorded are still valid.

B.22 At the end of the section, the measured length at the section end is recorded. The team leader then checks that all details have been recorded correctly and signs-off on the paper form. The team then drive to the next section.

### **Defects**

#### ***Defects to be recorded***

B.23 Table B.5 shows the defects to be recorded. In addition, gravel thickness can be recorded for gravel-surfaced roads.

#### ***Accuracy***

B.24 Correct and accurate recording in the field is essential if the results of inspections are to be useful and to avoid unnecessary effort in checking errors later. When completing the paper forms, legible recording of data is vital. Chainages and lengths should be recorded to the nearest whole metre, and widths should be recorded to the nearest 0.5 metre. Rut depth should be measured to the nearest millimetre.

#### ***Defect measurement***

B.25 The measuring wheel is run along the left-hand edge of the carriageway to give a continuous measurement of chainage within each sub-section. Difference in chainage measurements can be used to determine the length of any particular defect. Widths are measured at the start and finish of the defect using a tape measure. Where there are many defective areas, it may be helpful to mark them out with chalk to assist measurement.

**Table B.5 Defects to be recorded**

<i>Asphalt-surfaced pavements</i>	<i>Jointed-concrete pavements</i>	<i>Off-road features</i>
Ravelling.	Minor cracking.	<i>Kerb defects</i>
Major shoving.	Major cracking, scaling or fretting.	Verge:
Pot-holes.	Joint defects.	• Vegetation growth ('grass').
Edge deterioration.	Slab faulting.	• Deformation and scour.
Rutting.	Worn road markings.	<i>Footway trips</i>
Cracking.		Side drains:
Worn road markings.		• Silted or blocked.
		• Scoured or damaged.
		<i>Culverts:</i>
		• Silted or blocked.
		• Scoured or damaged.
		Damaged guard rails.
		Damaged retaining walls.
		Dirty, damaged or missing road signs.

B.26 Particular care should be taken when measuring rut depth on the far side of the carriageway from the vehicle. Whilst the measurement is being taken, other team members should keep a look out for traffic. These measurements should be taken as quickly as possible.

B.27 The following should be noted:

- For cracking and ravelling, defects of less than one metre in length and 0.5 metres wide should be ignored.
- Cracking is easier to identify when looking into the sun.
- Ravelling should only be recorded when the amount of stone loss is greater than the amount of stone remaining, within that particular area.
- All pot-holes should be recorded; small pot-holes should be recorded with a minimum size of 0.5m x 0.5m.
- Edge deterioration of less than one metre in length should be ignored.
- A note should be made on the form where fatting-up, bleeding or major shoving occur on bituminous carriageways.

#### ***Other defects***

B.28 If during the course of an inspection, anything is identified that should be brought to the immediate attention of the engineer, it should be noted. Examples might be:

- Road signs, retaining walls or guard rails in a dangerous condition.
- Water ponding on the road, or a blocked drain.
- Dangerous step at the edge of the carriageway.

If inspectors find dangerous debris on the carriageway, they should remove it. The reverse side of the inspection form can be used for recording notes. A note should also be made when there are no defects on a section. In such cases, depending on the method of data recording, a paper form should still be submitted.

## Examples of visual inspection procedure

B.29 Examples are given in the following sections of recording the defects occurring in four groups:

- Asphalt-surfaced pavements.
- Jointed-concrete pavements.
- Gravel roads.
- Off-road features.

B.30 In each case, the inspections start off in the same way. Section details and the date are recorded on the form. The measuring wheel is set to zero and set up at the start of the section on the left-hand edge of the carriageway (for traffic driving on the left). Carriageway and shoulder widths are measured with a tape, or with a second measuring wheel, if available. A new visual inspection form is used for each section. If there is insufficient space on a form to record all defects, then an additional form should be used, numbering it as 'Page 2' in the top right-hand corner.

B.31 In all cases, when the inspection of the section has been completed, the section length is recorded, and the inspection form is checked by the team leader and signed off. At the end of the survey, visual inspection forms are returned to the office for review by the maintenance engineer.

## Visual inspection of asphalt-surfaced pavements

B.32 An example of a typical defective bituminous section is shown in Figure B.3. In this example, defects of cracking, ravelling, edge deterioration and rutting are shown.

B.33 An example of an inspection form to record the defects illustrated in Figure B.3 is shown completed in Figure B.4. Many other inspection forms have been devised and used successfully but in this form, two columns are provided for the recording of cracking and ravelling, and one column each is provided for the recording of pot-holes, edge deterioration and rut depth. The form is divided vertically into pairs of rows. The form is filled in from the bottom-up. The lower left column of each pair of rows is used to record the start and end chainages of the occurrence of the defect. In the case of cracking and rutting, the top right column of each pair of rows is used to record the width of the defective area. The top left column of each of the pairs of rows is then used to calculate the difference in the chainages. Thus, entry onto the form progresses gradually up the page as the survey moves along the road. In the case of cracking and ravelling, a second column is provided if the first proves insufficient.

B.34 The inspector checks for any defects that are present at the start of the section. In this case, the following defects are present:

- Cracking in two locations.
- Edge deterioration left.

In the case of cracking: i) the numeral '0' chainage is entered in the bottom left ('Length') column of the bottom pair of rows, and the width of 0.5 metres is entered in the top right column of this pair of rows; ii) the numeral '0' chainage is entered in the bottom left ('Length') column of the next pair of rows, and the width of 4.0 metres is entered in the top right column of this pair of rows. In the case of edge deterioration left, the numeral '0' chainage is entered in the bottom of the 'Chainage' column under the appropriate heading on the form. No width is recorded for the edge deterioration. Note that the end-chainage figures will be recorded later.

B.35 Rut depth is recorded at regular intervals e.g. every 100 metres. Rut depth is measured for the outer wheel track on both the left and right-hand sides of the carriageway. The greater of these is the value recorded on the form together with the chainage.

B.36 The inspector pushes the measuring wheel along the road edge and looks for other defects starting, or existing defects stopping. Ravelling starts on the right-hand side of the road at Chainage 20, so this chainage figure (20) is recorded on the form under this heading. A width of 0.5m is also recorded.

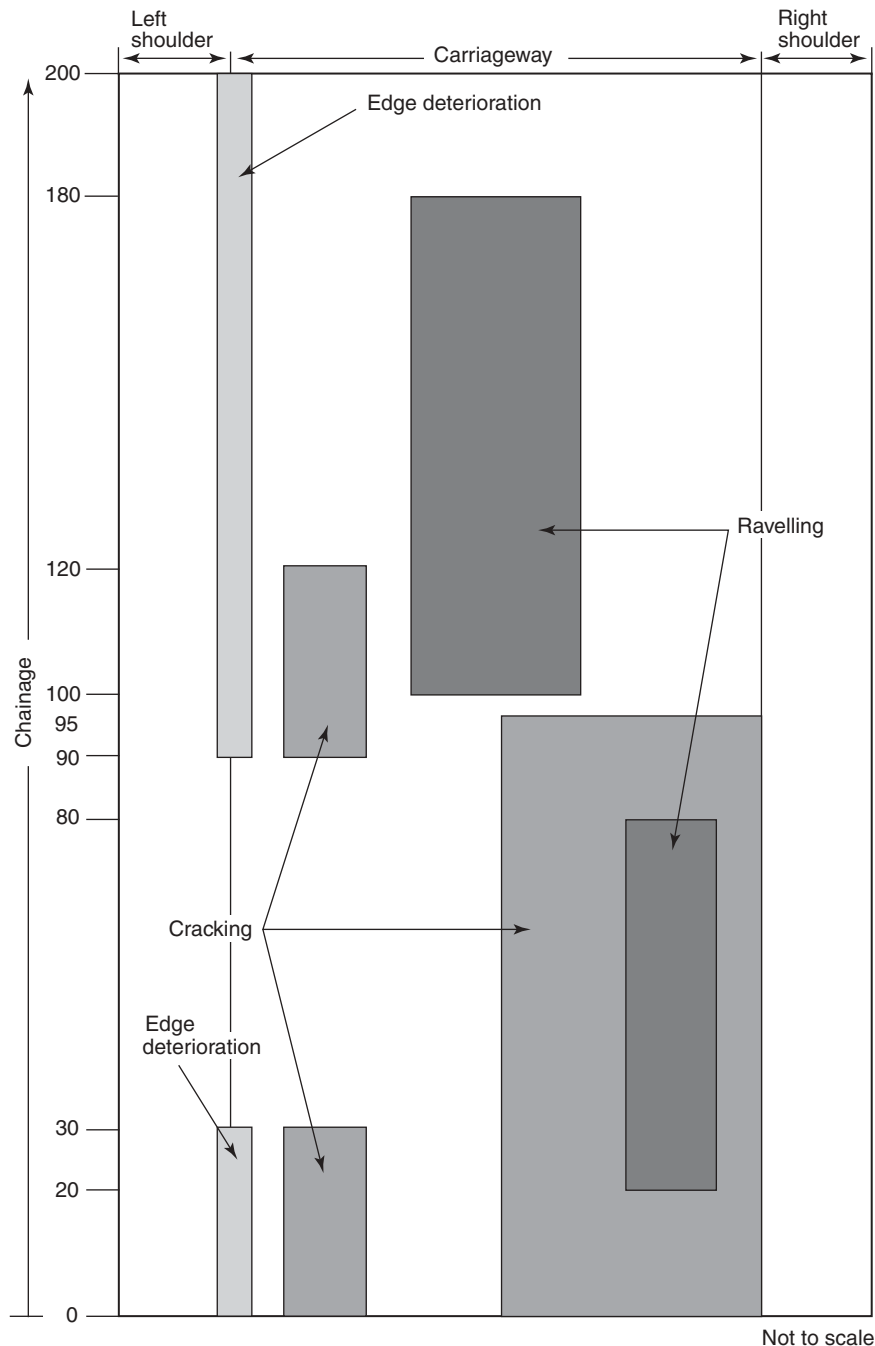

**Figure B3 Example of a defective sub-section**

B.37 At Chainage 30, both the left edge deterioration and the 0.5m wide cracking stop. The chainage value (30) is recorded in the appropriate column immediately above the start chainage, as shown.

B.38 The inspector continues along the road. At Chainage 80, the ravelling stops. This chainage value (80) is recorded above the start chainage for the defect, as shown on the form.

B.39 At Chainage 90, edge deterioration left starts, and a further area of cracking starts. The chainage value (90) is recorded for each of these defects, and the width of cracking is recorded as 0.5 metres.

B.40 At Chainage 95, the four-metre wide cracking stops. The chainage value (95) is recorded immediately above the start value (0).



B.41 The measurement process continues as the section is walked by the inspectors, continuing to record the start and finish of all other defects. When the end of the section has been reached, the measured length of the section is recorded on the form, and the carriageway width is measured and recorded. Note that, when carrying out the inspection, entries on the form should be cross-checked with defects on the road every 100 metres.

B.42 For each defect recording on the form, the start chainage is subtracted from the end chainage to give the length of defect which is entered in the next available box under the 'Length' heading.

### **Visual inspection of jointed-concrete pavements**

B.43 The recording of defects on concrete roads is much more straightforward than for bituminous roads. Entries consist of simple counts of defective joints or defective slabs. As each occurs, it can be checked off on the inspection form as shown in the example in Figure B.5. At the end of the section, the totals are added for each defect.

B.44 For concrete pavements without joints, it should be assumed that sections are divided into ten-metre lengths, each of which is treated as though it were a slab for measurement purposes. In such cases, no joint defects will be recorded.

### **Visual inspection of gravel roads**

B.45 Visual inspection of gravel roads can be used to identify the need for regravelling. An estimate can be made of the thickness of gravel on the road by examining pot-holes or by digging a small hole in the road surface until subgrade is reached and probing the depth with a measuring tape. Material should then be replaced and compacted with a hand tamper or punner. Ideally, thicknesses should be measured immediately after grading. But, in view of the difficulty of timing such measurements and the need to carry out surveys on a routine basis, the following approach may be more appropriate. The survey team should take measurements on each sub-section or at 200-metre intervals along the road. At each survey point, the team should identify any obvious ruts and should dig two holes: one in the rut and the other at the peak between ruts. The gravel thickness should be recorded as the average of the two measurements, as shown in Figure B.6.

### **Visual inspection of off-road features**

B.46 The recording of defects for the features of kerbs, footways, shoulders, side drains, guard rails and retaining walls all involve the measurement of defective length. An example of how the visual inspection form is completed for these is shown in Figure B.7.

B.47 As the inspector progresses along the section, it is observed that, at Chainage zero, the left-hand side drain is silted-up and there is high vegetation growth on the left-hand shoulder. A zero is entered in the appropriate columns at the bottom of the form.

B.48 Continuing along the road, at Chainage 20, damage has occurred to the left-hand guard rail: the value '20' is entered into the appropriate column. The guard-rail damage finishes at Chainage 70, and this value is entered on the form. The total length of damaged guard rail can now be found by subtracting the start and finish chainages to give the length of 50 metres, which is entered on the form in the appropriate column.

B.49 At Chainage 75, both the right-hand shoulder and side drain start to become scoured: the value '75' is entered into each of these columns. The scouring, in both cases, stops at Chainage 90, so this value is entered, and the length of scour determined by subtracting the chainage values in the same way as was done earlier for guard rails. This shows that 15 metres of scour is present on both the right-hand shoulder and in the side drain: these values are entered on the form.

B.50 Other values are entered in a similar way on the form as the road inspection proceeds. Note that, in the case of the left-hand side drain, there is a further section of siltation, 70-metres long, and a section of scour that is 15-metres long. These are added to give a total length of 195 metres in the total box at the bottom. Other values are transferred to the totals box as shown. The siltation of the side drain from the start of the section stops at Chainage 125, and the high vegetation stops at Chainage 210.

B.51 Total length of defects under each heading are recorded at the bottom of this part of the form. For example, in the case of side-drain siltation, the values 125 and 70 are added to give a total defective length of 195 metres.

B.52 As any culverts are reached during the survey, they are inspected for being silted or blocked, or being scoured or damaged. If a culvert is defective, the box is checked. In the example in Figure B.5, two culverts are silted or blocked and these entries are shown on the form, with the total number of defective culverts on the right.

B.53 A manual note is made of any damage to road signs, road markings, warning and information signs, traffic bollards, marker posts, etc, in the 'Sign report' box.



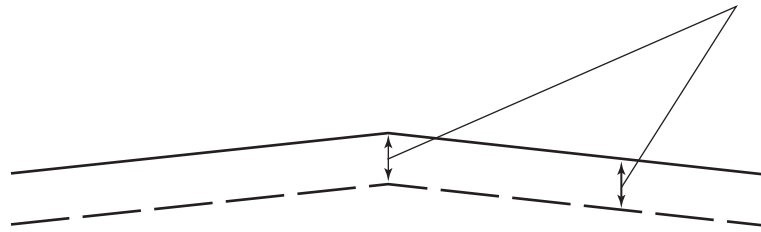

1. Measurement of gravel thickness  
on recently graded road

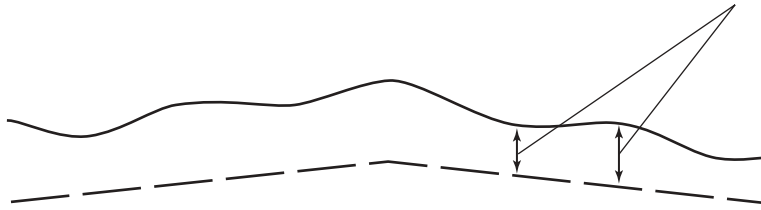

2. Measurement of gravel thickness  
on deteriorated road with four wheelpaths

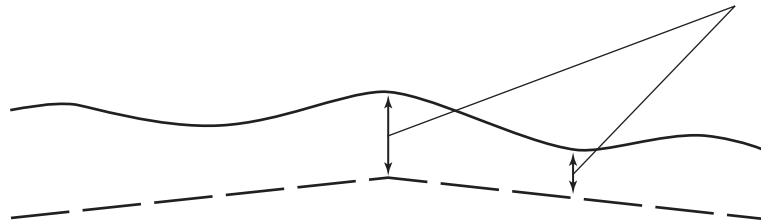

3. Measurement of gravel thickness  
on deteriorated road with two wheelpaths

**Figure B6 Measurement of gravel thickness**



## Appendix C: Traffic counts

---

### Manual counts

C.1 The equipment required for manual counting comprises a supply of pre-printed forms, pencils and clip-boards. A shelter from sun or rain may be required. At low traffic volumes, the work is not demanding and the main problem is likely to be ensuring that the enumerators stay on the job. Unscheduled visits by the engineer or a senior supervisor may be necessary to secure discipline and attention to the work. If the proportion of heavy vehicles in the traffic flows is expected to be high, classified counts may be necessary.

### Automatic counters

C.2 Cheap and reliable automatic traffic counters are available for recording total numbers of pairs of axles. These can be used to supplement manual counts or to count for periods of more than one day on low-volume roads. The equipment normally consists of a small rubber tube fixed across the road and attached to a pneumatic counter. When vehicles drive over the tube, it is compressed and a pulse of air triggers the counter. The instrument records one count for the passage of two axles. These traffic counters need careful adjustment to ensure that bicycles, motorcycles and pedestrians are not counted, and that heavy or fast vehicles are not 'double-counted'. Provided that they are checked regularly and the rubber tube replaced when it is damaged, their use is recommended for road maintenance management purposes.

C.3 Buried loop detectors can be used instead of pneumatic tubes, and are generally more reliable. However, their permanent installation will not normally be justified solely for traffic counts for maintenance purposes.

C.4 The maintenance engineer should select staff to be trained in the installation and use of counters, and to be responsible for their checking and maintenance. Arrangements should be made for the daily inspection of the counter and recording of the counter reading. In some locations, automatic counters may be subject to theft or damage. The counters themselves can be protected by lockable cabinets attached to solid objects, but the tubes cannot be effectively protected from deliberate interference. When this is experienced and regular inspection is not sufficient to prevent it, automatic counters of this type should not be used.

### Moving observer counts

C.5 Moving observer counts can be carried out by the maintenance engineer or supervisor in the course of personal inspections. A hand-tally can be used to record the number of vehicles. The flow can be estimated from the expression:

$$q = (x + y) / t$$

where  $q$  = total flow in both directions in time  $t$

$x$  = number of vehicles met (i.e. travelling in the opposite direction)

$y$  = number of vehicles that overtake the observer minus the number the observer overtakes

$t$  = journey time

C.6 This expression assumes that flows in each direction are equal. If the observer can drive so that the number of vehicles that overtake the observer are the same as the number the observer overtakes (this can usually be achieved at low traffic volumes), the expression becomes:

$$q = x / t$$

C.7 Counts of this type are useful as a cross-check on static counts. They can also be used to assess the extent of variations in flow from day-to-day, or between one season and another.

### Frequency and duration of counts

C.8 Where there are likely to be high daily or seasonal variations, the frequency or duration of counts should be increased from that recommended in Section 4. Daily variation is often affected by local market days, which may account for a high proportion of annual traffic on low-volume roads. These may be allowed for by making two counts, one on a market day and one on a non-market day. Where seasonal variation is high, a count should be carried out during each main climatic and/or agricultural season. This enables the effect of seasonal rainfall and variations in agricultural activity (especially during and just after harvest-time, when traffic flows usually show a marked increase) to be taken into account. Counts extending over 16 hours (from 6 am to 10 pm) will usually be adequate but, in some countries where traffic is heavy at night, counts should extend over 24 hours.

### Estimation of AADT from counts

C.9 The estimation of average annual daily traffic should take account of the factors noted above. The recommended procedure is demonstrated in the example in Box C.1.

#### Box C.1 Estimation of AADT from counts

Counts were taken near a village that has a market every seven days. The wet season lasts for about four months and the dry season eight months.

- Two 16-hour counts were taken at the end of the dry season (low level of agricultural activity)

Count on market day	= 73 vehicles
Count on non-market day	= 21 vehicles
- Two 16-hour counts were taken at the end of the wet season (harvest time)

Count on market day	= 94 vehicles
Count on non-market day	= 48 vehicles

For this example of a seven day traffic cycle, the average daily traffic is calculated for each season as follows.

$$\begin{aligned} \text{Average daily traffic (dry season): } T_{\text{dry}} &= (1/7 \times 73) + (6/7 \times 21) &&= 28 \text{ vehicles} \\ \text{Average daily traffic (wet season): } T_{\text{wet}} &= (1/7 \times 94) + (6/7 \times 48) &&= 54 \text{ vehicles} \end{aligned}$$

The AADT estimate is taken as the weighted mean of the seasonal flows, calculated thus:

$$\text{AADT} = (8/12 \times 28) + (4/12 \times 54) = 37 \text{ vehicles}$$



**Appendix D: Standard forms**

---







### Off-road features condition survey

District:							Date:								
Section:							Sub-section:								
Left							Right								
Shoulder/footway width: metres							Shoulder/footway width: metres								
Retaining wall	Guard rail	Side drain		Footway		Kerb	Kerb	Footway		Side drain		Guard rail	Retaining wall		
		Silted	Scour	Shoulder				Grass	Scour	Grass	Scour			Silted	Scour
				Grass	Scour										
Culverts		Silted/blocked													
		Scour/damage													
Sign report															

Signed.....Inspector

### Resource requirements and cost estimate

District:				
Activity:		Period:		
Section:		Budget:		
Length: km/metres		Width: metres		
Resource	Quantity	Unit	Rate	Cost
<b>Labour</b>				
Supervisors		Worker - day		
Unskilled		Worker - day		
Skilled 1		Worker - day		
2		Worker - day		
3		Worker - day		
4		Worker - day		
5		Worker - day		
6		Worker - day		
Sub-total				
<b>Equipment</b>				
1				
2				
3				
4				
5				
6				
7				
8				
Sub-total				
<b>Materials</b>				
1				
2				
3				
4				
5				
6				
7				
8				
Sub-total				
Total				

Signed .....



## Appendix E: Illustrations of defects

---

### Unpaved roads

#### *Roughness*



This road has corrugations approximately 75 mm deep. Access has not been lost and vehicle operating costs (VOCs) are not high, but the road is dangerous to travel on at speed as control can be easily lost. Dragging can eliminate initial minor corrugations and prevent the problem getting worse, but grading is required when they reach this advanced state. (Photograph courtesy of CSIR, South Africa)

#### *Surface distress (loss of camber, potholes, roughness)*



A camber is required to shed water from a carriageway. This secondary road has not been graded for a long time, the camber has been lost and potholes are developing. Each vehicle passage worsens the situation. The road should be reshaped as soon as possible. It is also noted that vegetation is encroaching onto the carriageway. Even if the camber is restored, this vegetation will retard drainage and prevent the carriageway drying out and gaining its full strength.

#### *Surface distress (loss of camber, rutting, potholes, loose materials)*



This road has not been maintained for many years. Vehicles make their own routes past erosion gullies. In wet weather, access is lost. In dry weather, access is possible for only those vehicles with high ground clearance. The road should be reconstructed if reliable access is to be provided.

### *Longitudinal erosion*



Longitudinal erosion is beginning to form deep gullies in this carriageway. Maintaining the camber with regular grading would have prevented this happening, although that is hard to do when the carriageway is as wide as this.

### *Dust*



This photograph shows the level of dust that can be generated from a gravel road. The dust brings health problems to villages, affects agricultural output, is dangerous when vehicles pass or attempt to overtake and demonstrates why gravel must be frequently replenished. (Photograph courtesy of CSIR, South Africa)



The fine soil on this road is dusty when dry and very slippery when wet. Gravel is hard to find in this area, so an improved surface, bituminous or non-bituminous, is recommended.

## Paved roads defects

### *Ravelling*



This road is losing its surface in long thin strips. It is probable that the spray bar on the bitumen sprayer was badly adjusted, producing narrow jets instead of overlapping sprays and leaving strips with low levels of bitumen. As a consequence the aggregate between the jets was poorly bound and has become detached by the wheels of passing traffic. In this advanced state, the road should be repaired with a surface dressing or other thin surface.

### *Fatting-up or bleeding*



Bitumen has risen to the surface of this road under the action of traffic. When the surface is smooth but aggregate is visible, the road is said to be fatting-up; when the binder rises further to form a continuous film, the road is said to be bleeding. Both conditions can be due to poor material control, low application rates of chippings, inadequate mixing, over-application of tack coat or secondary compaction of an asphalt surface. Treatment is not essential, but if a loss of skid resistance is a problem, treatment can include the rolling-in of heated aggregate or a new layer of surface dressing or asphalt. If severe, the asphalt may need to be removed before a new layer is constructed.

### *Surface shoving or creep*



The ruts and waves of asphalt caused by this severe shoving are unsafe to road users and are likely to grow further. The entire surface of the road should be removed and replaced.

### Major shoving



This defect is due to shoving of the base and sub-base. This shoving has resulted in a rut approximately half a metre deep which is extremely dangerous for passing traffic. An earlier repair is visible and suggests that water was allowed to enter the surface and soften the lower layers. Further investigation is likely to be required. At the very least the damaged material should be removed to the full depth of the road and the road reconstructed at this point.

### Pot-holes



Small cracks in this thin surfacing have allowed water to enter the granular base. The base has softened and the surfacing has collapsed into the pot-hole. The pot-hole now collects water and every time a vehicle passes through, material is splashed out and the pot-hole deepens. The pot-hole is a serious hazard to road users and their vehicles and should be patched urgently. Patching involves removing all weak material, cutting the surfacing back to beyond the extent of the hole, and reconstructing the road in layers.



If a pot-hole can be identified and repaired before it deepens and becomes a serious hazard, repair costs are saved and road users are not exposed to danger. The repair of this pot-hole is much simpler than that of the pot-hole in the photo above, although it is recommended that the top layer of unbound material is replaced as it may have degraded since the pot-hole opened.

### Old trench opening for utility



This trench has been poorly reinstated. The fill material, insufficiently compacted during the reinstatement, has settled under the weight of traffic. The rut is now dangerous to vehicles. The bituminous surface has deformed and cracked, letting water into the lower layers. The rut will deepen, presenting greater danger and placing the utility buried in the trench at risk of damage. The trench should be excavated and reinstated again.

### Edge damage



The edge of this road is breaking, probably due to the shoulder material wearing away. Vehicles driving close to the edge may lose control and veer towards the steep drop on the right. If not repaired, the road will gradually lose width and restrict the passage of vehicles. It is necessary to open up the defect to check that the base is not damaged further into the road and then repair the road with a patch. The shoulder should also be filled and compacted.



This thin surface is breaking away from the base layer. Although the step is very shallow and not dangerous, if the damage is not repaired with a small patch it will continue into the carriageway and require more extensive and costly repair. The base appears very dusty and so should be cleaned of all loose material before the repair is made.

### Edge step



The edge of this road has not broken but the shoulder material has worn away to leave a deep step which is a danger to passing vehicles and to those attempting to pull off the carriageway. The shoulder should be filled and compacted.

### Worn road markings



This centre line is now barely distinguishable from other marks on the road. If drivers expect to see road markings, particularly centre lines, but fail to see them, head on or corner-to-corner impacts are more likely. Road markings should always be repainted before they become as faint as is shown here.

*Cracking outside wheeltracks – along white line*



Cracks can occur in many positions on a paved road, including along white lines. White areas reflect sunlight while black areas absorb it and become hotter. Materials expand and contract from day to night according to their temperature. The difference in thermal movement along the edge of a white line on a dark road causes bitumen bonds to be broken and cracks to open up. The crack should be sealed, although, because water is unlikely to enter a crack along the crown of the road, repair is not urgent and can be carried out when the line is remarked.

*Cracking outside wheeltracks – parabolic crack*



Curved or parabolic cracks normally occur at sites where tyres place high lateral forces on the surface. These sites include junctions, sharp bends and steep hills. They do not indicate major structural damage, but inadequate adhesion between base and surface, due to a poor tack coat or polished aggregate. The damaged material should be removed and a patch constructed.



In extreme cases large areas of surface can slip. In this photo a twenty metre length of surface along the nearside wheeltrack has slipped from the base. The defect is localised and is not at a site where high lateral forces are applied. It is likely that the surface was poorly bonded to the base over this length. A surface patch is required.

*Cracking outside wheeltracks – lateral cracks*



This is a single jagged crack across the carriageway. Its width is greater than 3 mm and is therefore defined as a wide crack. Cracks such as this are often due to a weak longitudinal joint in an asphalt overlay or poor trench reinstatement. They may also be reflection cracks from the shrinkage of a stabilised base layer. The crack should be sealed. Unless further movement occurs, this defect is unlikely to become a serious problem.

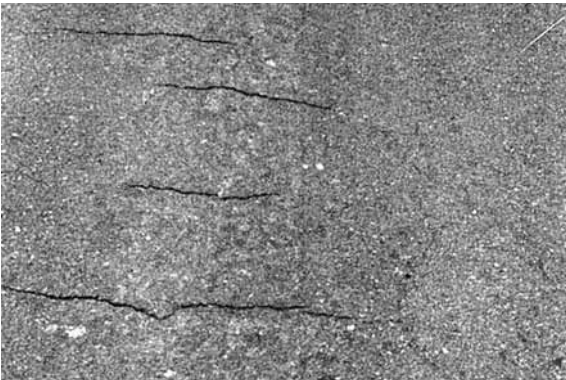

Transverse cracks at close spacing are often caused by thermal or shrinkage movement. They are more likely in areas of high day-night temperature change. Cracks such as these should be sealed.



This road consists of a narrow surface laid onto a wide base. It is a cost effective way of allowing high speed travel but retaining wide shoulders for slow moving or non-motorised traffic. The base is cracked, probably due to thermal movement. The crack is reflecting through the surfacing.



The very straight cracks across the road and between the outer and inner lane are due to poor construction techniques. The paving was not properly tied, with a stepped joint, to either the previous day's work or the neighbouring lane. The cracks should be sealed, after which no further movement is likely to occur.

*Cracking outside wheeltracks – block cracks*

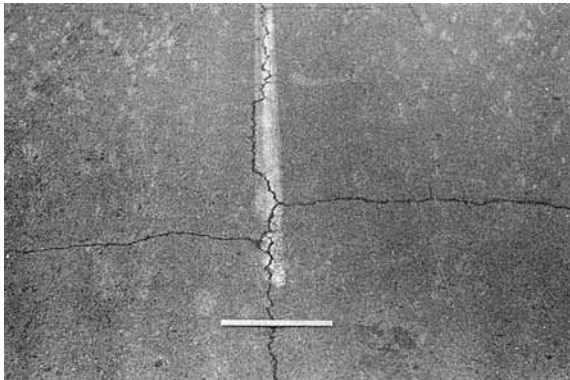

A combination of longitudinal and transverse cracks into blocks is normally due to either thermal or shrinkage movement of the upper layer or reflection of shrinkage in a stabilised base layer. The cracks are wide apart and should be sealed.

*Cracking in wheeltracks*



Longitudinal cracks are developing in the nearside wheeltrack. They may be due to movement in the sub-grade, either swelling or settlement. The cracks should be sealed and the area monitored for surface movement. Extensive cracks may require a surface dressing.

### *Crocodile cracking*



Closely spaced inter-connecting cracks are referred to as crocodile cracks. If there is no rutting, the most likely causes are poor construction of the surface layer, aged and inflexible binder, poor bond with the base layer. If the cracking is identified early, the cracks should be sealed. If the cracking has developed but is of limited extent, the affected area should be removed and patched. If the cracking has developed and is extensive, the length of road should be surfaced with asphalt or a surface dressing. If rutting is also present the road will need strengthening and detailed investigation is required.

### *Wheeltrack rutting*

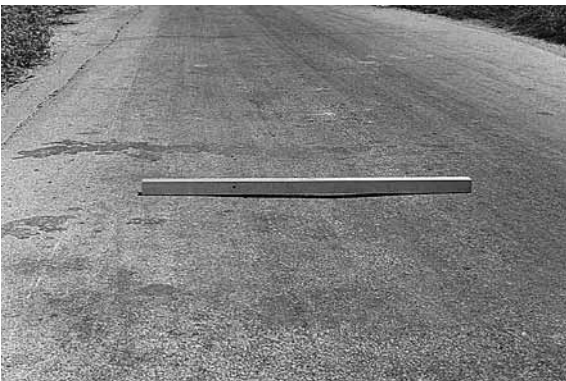

This photo shows a shallow rut with no cracking. It is not yet clear whether it is the surface or the lower layers that are deforming. It is recommended that a rut such as this is monitored as further deformation will indicate where the problem lies. If small cracks appear during the monitoring, they should be sealed. Continuing deformation will show that the road is not strong enough and an overlay may be required.



This rut has deepened. It is clear from the ridge on the right hand side that the asphalt is flowing under the action of traffic. This is referred to as 'shoving'. The material is incapable of supporting more traffic and should be removed and replaced. It may be possible to mill and inlay a narrow strip if the rutting is present in only one wheeltrack. Shoving often occurs on steep hills or at junctions where slow moving heavy vehicles impose very heavy loads on the road surface.

### *Wheeltrack rutting and cracking*

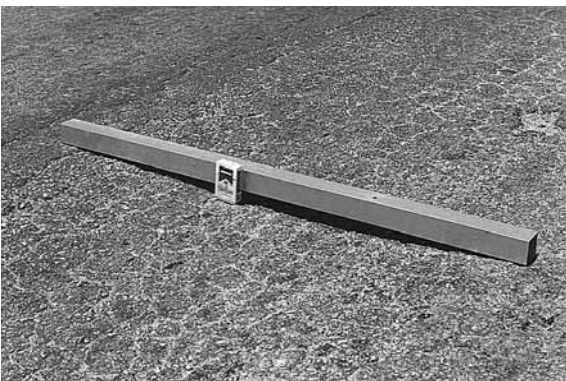

This road is rutted and cracked. It is not clear whether a deforming base has caused cracks to form in the surface or cracks have allowed water to enter and weaken the base. In this advanced state it is necessary to remove the damaged material – surface and base – and construct a patch. If repairs are not made soon, pot-holes will develop. Further investigation is recommended.

ISSN 0951-8797

**ORN 1**

**Road maintenance management for district engineers**